

User's Guide

ADS-2400N
ADS-2800W
ADS-3000N
ADS-3600W

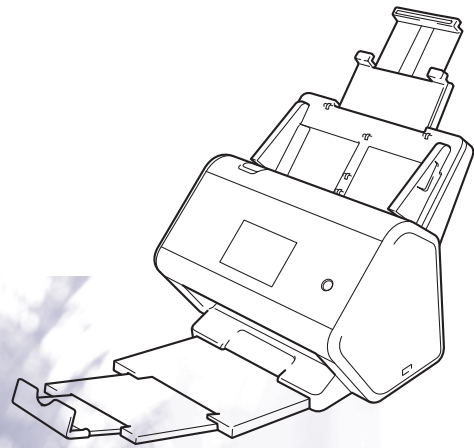

Brother Numbers

IMPORTANT

For technical help, you must call the country where you bought the machine. Calls must be made **from within** that country.

Register your product online at

www.brother.com/registration

By registering your product with Brother, you will be recorded as the original owner of the product. Your registration with Brother:

- may serve as confirmation of the purchase date of your product should you lose your receipt;
- may support an insurance claim by you in the event of product loss covered by insurance; and,
- will help us notify you of enhancements to your product and special offers.

Register your new product online at www.brother.com/html/registration

FAQs (Frequently Asked Questions)

The Brother Solutions Center is our one-stop resource for all your Brother machine needs. Download the latest software and user documentation, read FAQs and troubleshooting tips, and learn how to get the most from your Brother product.

support.brother.com

NOTE

- Check here for Brother driver updates.
 - To keep your machine performance up to date, check here for the latest firmware upgrade.
-

For Customer Service

In USA: 1-877-BROTHER (1-877-276-8437)
1-901-379-1215 (fax)

In Canada: www.brother.ca/support

If you have comments or suggestions, write us at:

In USA: Scanner Customer Support
Brother International Corporation
200 Crossing Boulevard
Bridgewater, NJ 08807-0911

In Canada: Brother International Corporation (Canada), Ltd.
Customer Experience Team
1, rue Hotel de Ville Dollard-des-Ormeaux, PQ, Canada H9B 3H6

Service center locator (USA only)

For the location of a Brother authorized service center, call 1-877-BROTHER (1-877-276-8437) or visit us on-line at www.brother-usa.com/service

Service center locations (Canada only)

For the location of a Brother authorized service center, visit us at www.brother.ca/support

Internet addresses

Brother Global Web Site: www.brother.com

For Frequently Asked Questions (FAQs), Product Support and Technical Questions, Driver Updates and Utilities, and User's Guides: support.brother.com

For Brother Accessories & Supplies:

In USA: www.brothermall.com

In Canada: www.brother.ca

User's Guides and Where Do I Find Them?

Which manual?	What's in it?	Where is it?
Quick Setup Guide	Follow the instructions for setting up your machine and installing the drivers and software for the operating system and connection type you are using.	Printed / In the box
Product Safety Guide	Read this Guide first before you set up your machine. See this Guide for the operating system and connection type you are using.	Printed / In the box
User's Guide	Learn the Scan operations and security features, learn how to perform routine maintenance, and see troubleshooting tips.	PDF file / Brother Solutions Center ¹
Network User's Guide	This Guide provides useful information about Ethernet network settings and security settings using the Brother machine. You can also find supported protocol information for your machine and detailed troubleshooting tips.	PDF file / Brother Solutions Center ¹
Web Connect Guide (ADS-2800W / ADS-3600W)	This Guide provides useful information about accessing Internet services from the Brother machine, as well as downloading images and uploading files directly from Internet services.	PDF file / Brother Solutions Center ¹
Mobile Print/Scan Guide for Brother iPrint&Scan (ADS-2800W / ADS-3600W)	This Guide provides useful information about scanning from your Brother machine to your mobile device when connected to a WiFi network. See this Guide for information about using this app to print from a mobile device to a device that supports printing.	PDF file / Brother Solutions Center ¹
Brother Image Viewer Guide for Android™	This Guide provides useful information about using your Android™ mobile device to view and edit documents that were scanned by a Brother machine.	PDF file / Brother Solutions Center ¹
Brother ScanViewer Guide for iOS/OS X	This Guide provides useful information about using your iOS device or Macintosh computer to view and edit documents that were scanned by a Brother machine and saved to iCloud.	PDF file / Brother Solutions Center ¹

¹ Visit Brother Solutions Center at support.brother.com

Getting Started

Features		Applications	What Can I Do?	Where Should I Go for More Information?
Scan to PC	Scan to Image	ControlCenter4 (Windows®) ControlCenter2 (Macintosh)	Scan your document directly into a graphics application for image editing.	<p>For scanning from the Control Panel of the machine:</p> <ul style="list-style-type: none"> ■ Home Mode: <i>Save Scanned Documents on Your Computer in Home Mode</i> on page 152 ■ Advanced Mode: <i>Save Scanned Documents on Your Computer in Advanced Mode</i> on page 155 <p>For scanning from ControlCenter4 (Windows®):</p> <ul style="list-style-type: none"> ■ Home Mode: <i>Basic Scan</i> on page 81 ■ Advanced Mode: <i>Basic Scan</i> on page 88 <p>For scanning from ControlCenter2 (Macintosh):</p> <p><i>Scan to Image</i> on page 108</p>
	Scan to OCR		Scan your document and convert it to text. This text can be edited using your favorite word processing software.	<p>For scanning from the Control Panel of the machine:</p> <ul style="list-style-type: none"> ■ Home Mode: <i>Save Scanned Documents on Your Computer in Home Mode</i> on page 152 ■ Advanced Mode: <i>Save Scanned Documents on Your Computer in Advanced Mode</i> on page 155 <p>For scanning from ControlCenter4 (Windows®):</p> <ul style="list-style-type: none"> ■ Home Mode: <i>Basic Scan</i> on page 81 ■ Advanced Mode: <i>Basic Scan</i> on page 88 <p>For scanning from ControlCenter2 (Macintosh):</p> <p><i>Scan to OCR</i> on page 109</p>

Features		Applications	What Can I Do?	Where Should I Go for More Information?
Scan to PC (continued)	Scan to email	ControlCenter4 (Windows®) ControlCenter2 (Macintosh) (continued)	Scan your document to your default email application, to send the scanned job as an attachment.	<p>For scanning from the Control Panel of the machine:</p> <ul style="list-style-type: none"> ■ Home Mode: <i>Save Scanned Documents on Your Computer in Home Mode</i> on page 152 ■ Advanced Mode: <i>Save Scanned Documents on Your Computer in Advanced Mode</i> on page 155 <p>For scanning from ControlCenter4 (Windows®):</p> <ul style="list-style-type: none"> ■ Home Mode: <i>Basic Scan</i> on page 81 ■ Advanced Mode: <i>Basic Scan</i> on page 88 <p>For scanning from ControlCenter2 (Macintosh): <i>Scan to E-mail</i> on page 110</p>
	Scan to File		Scan your document and save it to a folder on your hard disk in one of the file types shown in the file type list. To scan your document as a PDF file, select this method.	<p>For scanning from the Control Panel of the machine:</p> <ul style="list-style-type: none"> ■ Home Mode: <i>Save Scanned Documents on Your Computer in Home Mode</i> on page 152 ■ Advanced Mode: <i>Save Scanned Documents on Your Computer in Advanced Mode</i> on page 155 <p>For scanning from ControlCenter4 (Windows®):</p> <ul style="list-style-type: none"> ■ Home Mode: <i>Basic Scan</i> on page 81 ■ Advanced Mode: <i>Basic Scan</i> on page 88 <p>For scanning from ControlCenter2 (Macintosh): <i>Scan to File</i> on page 111</p>

Features		Applications	What Can I Do?	Where Should I Go for More Information?
Scan to PC (continued)	Scan Using the TWAIN/WIA Driver for Windows® Users	Applications supporting TWAIN/WIA driver include: Nuance™ PaperPort™ 14SE Windows® Fax and Scan Windows® Photo Gallery	Use the Nuance™ PaperPort™ 14SE application included in the Brother MFL-Pro software suite, or other applications supporting TWAIN or WIA specifications, for scanning.	For scanning using the TWAIN/WIA driver: <i>Scan Using Nuance™ PaperPort™ 14SE or Other Windows® Applications</i> on page 126
	Scan Using the TWAIN/ICA Driver for Macintosh Users	Applications supporting ICA driver such as: ABBYY FineReader Pro Applications supporting TWAIN/ICA driver include: Apple Image Capture	Use the applications supporting TWAIN specifications, for scanning. After installing the Brother MFL-Pro software suite, you can also use the Apple Image Capture application for scanning.	For scanning using the TWAIN driver: <i>Scan Using TWAIN Applications (Macintosh)</i> on page 144 For scanning using the ICA driver: <i>Scan Using Apple Image Capture (ICA Driver)</i> on page 148
	WS Scan (Windows® users only) (ADS-2800W / ADS-3600W)	Windows® Fax and Scan Windows® Photo Gallery	Scan your document by using the Web Services protocol. The Web Services protocol enables you to scan over the network using your machine and a computer running Windows Vista® (SP2 or later), Windows® 7, Windows® 8 or Windows® 8.1.	For installing drivers: <i>Install Drivers Used for Scanning via Web Services (Windows Vista®, Windows® 7, Windows® 8, Windows® 8.1)</i> in the <i>Network User's Guide</i> For scanning from the Control Panel of the machine: <i>Scan Using Web Services (Windows Vista® SP2 or Later, Windows® 7, Windows® 8 and Windows® 8.1)</i> on page 202

Features		Applications	What Can I Do?	Where Should I Go for More Information?
Scan from the Control Panel of the Machine	Scan to USB	—	Scan your document and save the scanned image on a USB flash drive. (ADS-2800W / ADS-3600W) You can configure the settings on the machine's control panel.	<i>Save Scanned Documents on a USB Flash Drive</i> on page 158
	Scan to FTP		Scan your document directly to an FTP server on your local network, or on the Internet.	<i>Scan Documents to an FTP Server</i> on page 164
	Scan to SFTP		Scan your document directly to an SFTP server on your local network, or on the Internet.	<i>Scan Documents to an SFTP Server</i> on page 174
	Scan to SharePoint		Scan your document directly to SharePoint server.	<i>Scan Documents to SharePoint</i> on page 194
	Scan to Apps		Convert the scanned data to a Excel.	Network User's Guide
	Scan to Network (Windows® users only)		Scan your document directly to a shared folder on your local network, or on the Internet.	<i>Scan Documents to a Shared Folder / Network Location (Windows®)</i> on page 184
	Scan to email Server (ADS-2800W / ADS-3600W)	—	Scan your document and send it directly to an email address from the machine. In addition, because this feature can assign an email address to the machine, you can use the machine to send documents over your local network or the Internet to computers.	<i>Send Scanned Documents Directly to an Email Address (ADS-2800W / ADS-3600W)</i> on page 204
	Scan to Web (ADS-2800W / ADS-3600W)		Scan your document and upload it directly to Web Services, such as Evernote, Dropbox, Box, and OneDrive, without using a computer.	<i>Web Connect Guide</i>

Features		Applications	What Can I Do?	Where Should I Go for More Information?
From Mobile Devices	Scan Documents (Brother iPrint&Scan)	Brother iPrint&Scan	Scan your document directly from your Android™ devices, iOS devices, and Windows® Phone without using a computer. Download and install Brother iPrint&Scan from the Google Play, App Store, or Windows® Phone Store.	<i>Mobile Print/Scan Guide for Brother iPrint&Scan</i>
	View or Edit Scanned Data (iOS/OS X) (ADS-2800W / ADS-3600W)	Brother ScanViewer	Use your iOS device or Macintosh computer to view and edit images and documents that were scanned by a Brother machine and saved to iCloud. Download and install Brother ScanViewer from the App Store.	<i>Brother ScanViewer Guide for iOS/OS X</i>
	View or Edit Scanned Data (Android™) (ADS-2800W / ADS-3600W)	Brother Image Viewer	Use your Android™ mobile device to view and edit documents that were scanned by a Brother machine. Download and install Brother Image Viewer from Google Play.	<i>Brother Image Viewer Guide for Android™</i>

You Can Use the Following Features

Manage the machine securely

Feature	Description	Where Should I Go for More Information?
Secure Function Lock 3.0 (ADS-2800W / ADS-3600W)	Allows users to choose which functions each user can use.	<i>Secure Function Lock 3.0</i> on page 41
Active Directory Authentication (ADS-2800W / ADS-3600W)	Restricts the use of the Brother machine unless users enter the user ID and password.	<i>Active Directory Authentication</i> (ADS-2800W / ADS-3600W) on page 49
Setting Lock (ADS-2800W / ADS-3600W)	Allows only users who know the password to change the machine's settings.	<i>Setting Lock</i> (ADS-2800W / ADS-3600W) on page 39
LDAP Authentication	Restricts the use of the Brother machine unless users enter the user name and Password.	<i>LDAP Authentication</i> (ADS-2800W / ADS-3600W) on page 50

Streamlining Work

Feature	Description	Where Should I Go for More Information?
Scan Using Near Field Communication (NFC) (ADS-3600W)	Allows you to scan using the settings you saved when you registered your NFC ID card to a Shortcut.	<i>Adding ID Card Shortcuts</i> (ADS-3600W only) on page 16
BRAdmin Light (Windows® only) BRAdmin Professional 3 (Windows® only)	Allows you to manage a Brother machine connected to the network. Using a computer, search for Brother machines on the network, display device status information, and change network settings.	<i>Launch the BRAdmin Utility</i> (Windows®) on page 76
One touch scan (ADS-2800W / ADS-3600W)	Allows you to use one button to scan documents with your favorite settings. To use this function, you must create a one touch setting in your shortcut and add the shortcut number on your Home screen.	<i>Shortcut Settings</i> (ADS-2800W / ADS-3600W) on page 12

Saving Space and Managing Your Data

Feature	Description	See
Scan to FTP/SFTP	Allows you to transmit scanned data directly to an FTP/SFTP server without using a computer. This feature makes it easy to share large data files that cannot be sent by email.	<i>Scan Documents to an FTP Server</i> on page 164 <i>Scan Documents to an SFTP Server</i> on page 174
Scan to SharePoint	Allows you to transmit scanned data directly to SharePoint without using a computer.	<i>Scan Documents to SharePoint</i> on page 194
Scan to Email server (ADS-2800W / ADS-3600W)	Allows you to scan a document and send it directly to an email address from the machine.	<i>Send Scanned Documents Directly to an Email Address</i> (ADS-2800W / ADS-3600W) on page 204
Scan to Web (ADS-2800W / ADS-3600W)	Allows you to scan a document and upload it directly to Web Services.	<i>Upload Scanned Documents to the Web</i> (ADS-2800W / ADS-3600W) on page 211
Scan to Network	Allows you to scan your documents and upload it directly to Network.	<i>Scan Using Scan to Network Profiles</i> on page 192

Table of Contents

1	General Information	1
	Using the Documentation	1
	Symbols and Conventions Used in the Documentation	1
	About This Machine	2
	Control Panel Overview (ADS-2400N / ADS-3000N)	3
	Control Panel Overview (ADS-2800W / ADS-3600W).....	5
	Touchscreen LCD.....	6
	Basic Operations	10
	Shortcut Settings (ADS-2800W / ADS-3600W).....	12
	Adding Scan Shortcuts	12
	Adding Web Connect Shortcuts	14
	Adding Apps Shortcuts	15
	Adding ID Card Shortcuts (ADS-3600W only).....	16
	Changing Shortcuts	16
	Editing Shortcut Names.....	17
	Deleting Shortcuts	17
	Recalling Shortcuts.....	17
	Accessing Brother Utilities (Windows®).....	18
	General Setup (ADS-2400N / ADS-3000N).....	19
	Set Date&Time	19
	Set Sleep Time	23
	Select Your Language	27
	Assign the Scan Feature to the Network Device Key 1-3.....	31
	General Setup (ADS-2800W / ADS-3600W)	34
	Set the Backlight Brightness.....	34
	Set the Dim Timer for the Backlight.....	34
	Set the Home Screen	34
	Select Your Language	35
	Memory Storage	35
	Beep Volume	35
	Automatic Daylight Saving Time.....	36
	Sleep Time	36
	Auto Power Off	37
	Multifeed Detection.....	38
	Setting Lock (ADS-2800W / ADS-3600W).....	39
	Set the Password	39
	Change the Password	39
	Turn Setting Lock On/Off.....	40
	Secure Function Lock 3.0	41
	Before You Use Secure Function Lock 3.0	42
	Turning Secure Function Lock On/Off.....	43
	Configure Secure Function Lock 3.0 Using Web Based Management	44
	Setting Up Card Authentication for Users (For ADS-3600W).....	46
	Setting Up and Changing the Public Mode.....	46
	Switching Users.....	48
	Active Directory Authentication (ADS-2800W / ADS-3600W)	49
	Turning Active Directory Authentication Lock On/Off	49

LDAP Authentication (ADS-2800W / ADS-3600W)	50
Turning LDAP Authentication Lock On/Off	50

2 Document Specifications 51

Acceptable Documents	51
Unacceptable Documents	53
Loading Capacity	54
Area Not to be Perforated	55
Conditions for Multifeed Detection	55
Scanning a Mixed Batch	56
Carrier Sheet Recommendations	57
Notes for Using Carrier Sheets	58

3 Scan Preparation 59

Set Up Your Scanner	59
Load Documents	60
Standard-size Documents	60
Business Cards	62
Plastic Cards	64
Documents Longer than Standard Size	65
Documents Printed on Non-standard Size Paper	66
Documents with Facing Pages	67
Receipts, Clippings, Photos, and Other Documents	67

4 Prepare Your Network for Scanning with Your Computer 69

Before Scanning	69
Before Network Scanning	70
Network License (Windows®)	70
Configure Network Scanning for Windows®	70
Configure Network Scanning for Macintosh	74
Launch the BRAdmin Utility (Windows®)	76

5 Before Scanning 77

6 Scan Using Your Computer 78

Change the ControlCenter4 User Interface (Windows®)	78
Scan Using ControlCenter4 in Home Mode (Windows®)	81
Basic Scan	81
Scan Documents Using the Carrier Sheet	82
Scan Plastic Cards	84
Scan Documents to SharePoint	86
Scan Using ControlCenter4 in Advanced Mode (Windows®)	88
Basic Scan	88
Scan to Image	89
Scan to OCR	90
Scan to E-mail	91
Scan to File	92
Change a Scan Button's Default Settings	93

Scan Using the Carrier Sheet.....	93
Scan Plastic Cards	94
Scan Documents to SharePoint	96
Create a Custom Tab (ControlCenter4 Advanced Mode) (Windows®).....	98
Create a Custom Tab	98
Create a Custom Button in a Custom Tab.....	99
Change Scan Settings (ControlCenter4) (Windows®).....	100
Scan Using ControlCenter2 (Macintosh)	107
Scan to Image	108
Scan to OCR	109
Scan to E-mail	110
Scan to File.....	111
Change a Scan Button's Default Settings	112
Scan Specific and Irregular Sized Documents Using the Carrier Sheet.....	112
Scan Plastic Cards	114
Register Your Favorite Scan Settings Using ControlCenter2 (Macintosh)	116
User-defined Button.....	117
Change Scan Settings (ControlCenter2) (Macintosh)	120
Scan Using Nuance™ PaperPort™ 14SE or Other Windows® Applications	126
Scan Using Nuance™ PaperPort™ 14SE.....	126
Scan Using Windows® Photo Gallery or Windows® Fax and Scan	142
Use ABBYY FineReader.....	143
Scan Using TWAIN Applications (Macintosh).....	144
Scan Using TWAIN Applications (for example, Presto! PageManager).....	144
TWAIN Driver Settings	145
Scan Using Apple Image Capture (ICA Driver)	148
Scan Using Apple Image Capture	148
ICA Driver Settings.....	150

7 Scan Using the Control Panel

152

Save Scanned Documents on Your Computer in Home Mode	152
Save Scanned Documents on Your Computer in Advanced Mode.....	155
Save Scanned Documents on a USB Flash Drive.....	158
Save Scanned Documents on Mobile Devices.....	162
Scan Documents to an FTP Server	164
Start Web Based Management	164
Configure the FTP Default Settings.....	167
Scan Using FTP Server Profiles.....	172
Scan Documents to an SFTP Server.....	174
Start Web Based Management	174
Configure the SFTP Default Settings	177
Scan Using SFTP Server Profiles	182
Scan Documents to a Shared Folder / Network Location (Windows®)	184
Start Web Based Management	184
Configure the Scan to Network Default Settings	187
Scan Using Scan to Network Profiles.....	192
Scan Documents to SharePoint.....	194
Start Web Based Management	194
Set Up a Scan to SharePoint Profile	197
Scan Using Web Services (Windows Vista® SP2 or Later, Windows® 7, Windows® 8 and Windows® 8.1)	202
Configuring Settings for Scanning.....	203

Send Scanned Documents Directly to an Email Address (ADS-2800W / ADS-3600W)	204
Select an Email Address from the Address Book	205
Enter an Email Address Manually	206
Set Up the Address Book (ADS-2800W / ADS-3600W)	207
Register an Email Address	207
Change an Email Address	207
Delete an Email Address	208
Set Up a Group	209
Change a Group	209
Delete a Group	210
Upload Scanned Documents to the Web (ADS-2800W / ADS-3600W)	211
Change Scan to PC Settings (Windows®)	212
Change Scan to PC Settings (Macintosh)	220
Scan Options Using the Touchscreen (ADS-2800W / ADS-3600W)	227
Skip Blank Page Function	227
Adjust the Scanning Position	227
Scan a Specific Area	228
Adjust Brightness	228
Adjust Contrast	228
Automatically Detect Whether a Document Uses Color	229
Color Tone Adjustment	229
Auto Color Detect Adjust	229

8 Managing the Machine from Your Computer 230

Monitor the Machine's Status from Your Computer (Windows®)	230
Status Monitor Indicators	231
Monitor the Machine's Status from Your Computer (Macintosh)	233
Turn the AutoLoad Feature On/Off (ControlCenter2)	234
Set Up the Brother Machine from Your Computer	235

9 Routine Maintenance 239

Clean the Outside of the Machine	239
Clean the Scanner and Rollers	241
Replace Supplies	245
Part Names, Numbers, and Life Cycles	245
Check Supplies Replacement Cycle (ADS-2400N / ADS-3000N)	247
Check Supplies Replacement Cycle (ADS-2800W / ADS-3600W)	250
Replace the Pick Up Roller	250
Replace the Reverse Roller	253
Reset the Usage Counters	255
Reset the Usage Counters (ADS-2800W / ADS-3600W)	258
Packing and Shipping the Machine	259

10 Troubleshooting 262

Overview	262
Identifying Your Problem	262
Error and Maintenance Messages	262
Document Jam	266
Operational and Software Difficulties	268
Machine Information	275

Check the Serial Number (ADS-2400N / ADS-3000N).....	275
Check the Serial Number (ADS-2800W / ADS-3600W).....	277
WLAN Enable/Disable (ADS-2800W / ADS-3600W).....	277
Reset Functions.....	278
Reset the Machine (ADS-2400N / ADS-3000N).....	278
Reset the Machine (ADS-2800W / ADS-3600W).....	279

A Specifications 280

General.....	280
Scanner.....	282
Direct Scan Feature (Scan to USB).....	282
Interfaces.....	283
Network.....	283
Computer Requirements.....	284

B Appendix 285

Entering Text (ADS-2800W / ADS-3600W).....	285
Inserting Spaces.....	285
Making Corrections.....	285
LED Indications (ADS-2400N / ADS-3000N).....	286
Service Call Indications.....	297
Scan Settings.....	298

C Index 304

Using the Documentation

Thank you for buying a Brother machine! Reading the documentation will help you make the most of your machine.

Symbols and Conventions Used in the Documentation

The following symbols and conventions are used throughout the documentation.

 CAUTION	<u>CAUTION</u> indicates a potentially hazardous situation which, if not avoided, may result in minor or moderate injuries.
IMPORTANT	<u>IMPORTANT</u> indicates a potentially hazardous situation which, if not avoided, may result in damage to property or loss of product functionality.
NOTE	<u>Notes</u> tell you how you should respond to a situation that may arise or give tips about how the operation works with other features.
Bold	Bold typeface identifies keys on the machine control panel or computer screen.
<i>Italics</i>	Italicized typeface emphasizes an important point or refers you to a related topic.
Courier New (ADS-2800W / ADS-3600W)	Text in Courier New font identifies messages on the machine's Touchscreen.

NOTE

- Unless otherwise specified, screens and illustrations in this guide show the ADS-3600W.
 - Unless otherwise specified, the screens in this manual are from Windows® 7 and OS X 10.10.x. Screens on your computer may vary depending on your operating system.
-

About This Machine

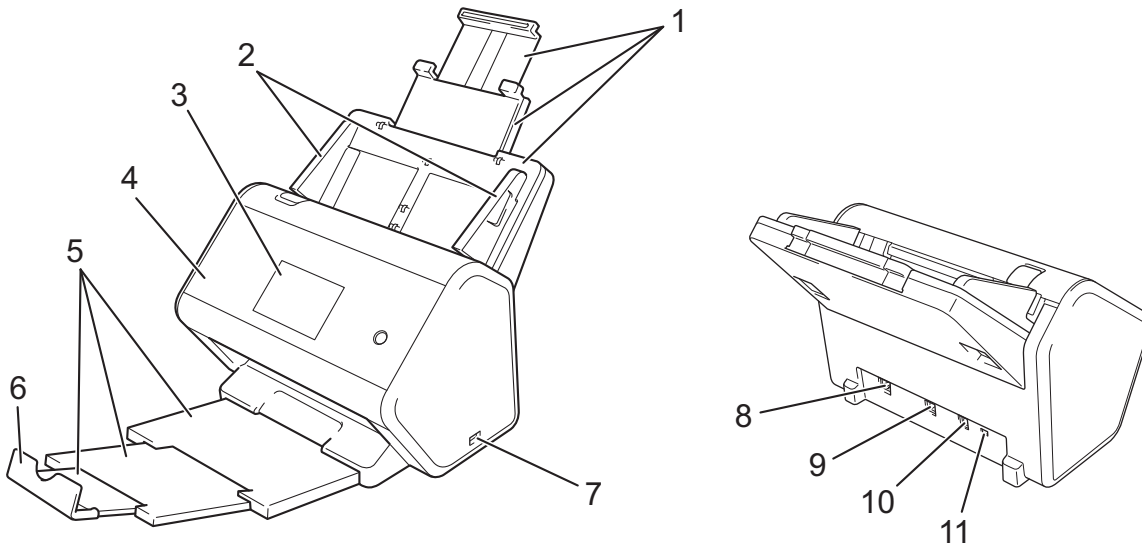

- 1 Extendable Automatic Document Feeder (ADF)**
- 2 Paper Guides**
- 3 Control Panel (ADS-2800W / ADS-3600W)**
- 4 Front Cover**
- 5 Extendable Output Tray**
- 6 Document Stopper**
- 7 USB 2.0 Port**
- 8 Ethernet Cable Port**
- 9 Hi-Speed USB 2.0 Port (ADS-2400N / ADS-2800W)
USB 3.0 SuperSpeed Port (ADS-3000N / ADS-3600W)**
- 10 AC Adapter Connector**
- 11 Security Slot**

Control Panel Overview (ADS-2400N / ADS-3000N)

1

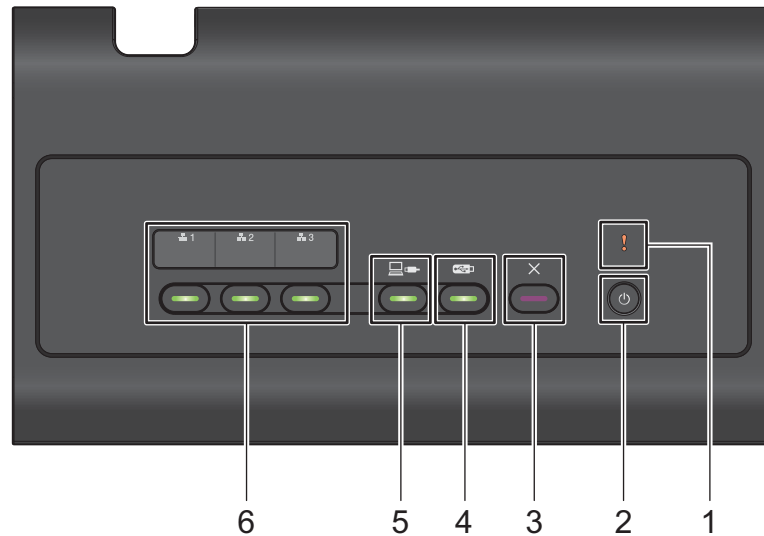



1 Error Indicator (with LED)

The Error Indicator indicates that the machine is in an error state. For more information, see *LED Indications (ADS-2400N / ADS-3000N)* on page 286.

2 Power button (with LED)

Turn the machine on and off.

Press  to turn the machine on.

Hold down  to turn the machine off.

3 Stop button

Press the Stop button to:

- Stop document feed
- Cancel a job
- Wake the machine up
- Recover from an error
- Disconnect Remote Setup

4 Scan to USB button (with LED)

Press the Scan USB button to:

- Scan to USB
- Wake the machine up

5 Scan to PC button (with LED)

Press the Scan to PC button (USB Connect) to:

- Scan to PC
- Wake the machine up

6   

Assign the Scan to FTP/SFTP, Scan to Network, Scan to Sharepoint, Scan to PC (Network Connect), or WS Scan function to these keys. After configuring the settings, press to select your assigned function. These buttons are available only when the machine is set up using the wired network method with the installation DVD-ROM and a USB cable (see the *Quick Setup Guide*). For more information, see *Scan Documents to an FTP Server* on page 164, or *Scan Using Web Services (Windows Vista® SP2 or Later, Windows® 7, Windows® 8 and Windows® 8.1)* on page 202.

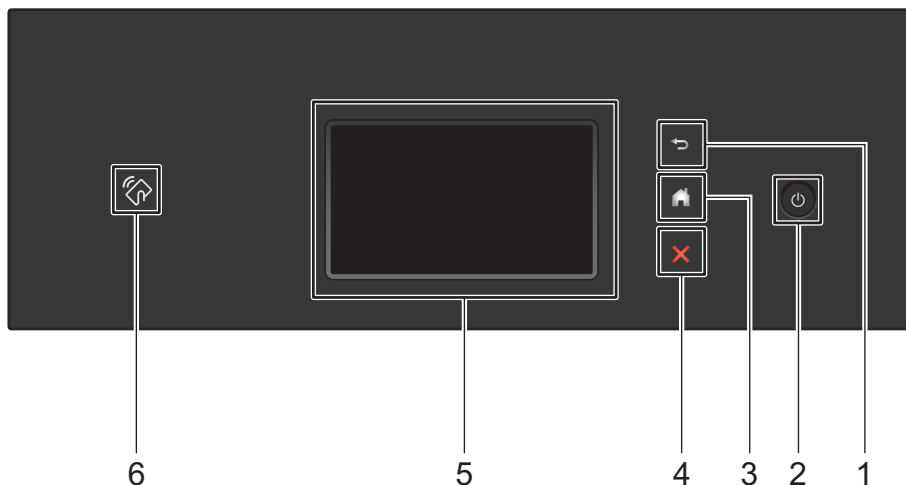

Control Panel Overview (ADS-2800W / ADS-3600W)



1 (Back Button)

Press to go back to the previous screen or menu. The Back button does not light up when it is unavailable.

2 (Power On/Off)

Press  to turn on the machine. Press and hold down  to turn off the machine. The Touchscreen displays *Shutting Down* and stays on for a few seconds before going off.

3 (Home Button)

Press to return to the Home Screen and Ready Mode. The Home button does not light up when it is unavailable.

4 (Stop Button)

Press to stop or cancel your current action and return to Ready Mode. The Stop button does not light up when it is unavailable.

5 Touchscreen LCD

Access the menus and options by pressing the Touchscreen.

6 NFC (Near Field Communication) Reader

(ADS-3600W)

Use card authentication by touching the IC card to the NFC Reader on the control panel.

If your Android™ device supports the NFC standard, scan to your device by touching it to the NFC logo. You must download and install Brother iPrint&Scan to your Android™ device to use this feature.

(See *Scanning with Near Field Communication (NFC)* on page 24.)

Touchscreen LCD

Select from four types of screens for the Home screen. When the Home screen is displayed, change the displayed screen by swiping left or right, or pressing ◀ or ▶.

The following screens display the machine's status when the machine is idle.

<p>The Scan 1 screen displays three shortcuts: 'to Web' (document icon), 'to PC' (laptop icon), and 'to Network' (folder icon). It also features a 'WiFi' icon, a 'Shortcuts' button, and a status bar showing '12:00 Sun 01.01.2016'. Numbered callouts 1-6 point to the WiFi icon, the shortcuts area, the 'to Web' shortcut, the 'to PC' shortcut, the 'to Network' shortcut, and the status bar respectively.</p>	<p>Scan 1 screen</p> <p>The Scan 1 screen provides access to the scan features, such as Scan to Web, Scan to PC, and Scan to Network.</p>
<p>The Scan 2 screen displays three shortcuts: 'to FTP/SFTP' (server rack icon), 'to E-mail Server' (envelope icon), and 'to SharePoint' (SharePoint 'S' icon). It also features a 'WiFi' icon, a 'Shortcuts' button, and a status bar showing '12:00 Sun 01.01.2016'. Numbered callouts 7-9 point to the 'to FTP/SFTP' shortcut, the 'to E-mail Server' shortcut, and the 'to SharePoint' shortcut respectively.</p>	<p>Scan 2 screen</p> <p>The Scan 2 screen provides access to the scan features, such as Scan to FTP/SFTP, Scan to E-mail Server, and Scan to SharePoint.</p>
<p>The Scan 3 screen displays three shortcuts: 'Apps' (blue cube icon), 'WS Scan' (laptop icon), and 'to USB' (USB drive icon). It also features a 'WiFi' icon, a 'Shortcuts' button, and a status bar showing '12:00 Sun 01.01.2016'. Numbered callouts 10-12 point to the 'Apps' shortcut, the 'WS Scan' shortcut, and the 'to USB' shortcut respectively.</p>	<p>Scan 3 screen</p> <p>The Scan 3 screen provides access to scan features, such as WS-Scan, Scan to USB, and Apps.</p>

NOTE

“Swiping” means sliding your finger across the Touchscreen to display the next page or item.



1 **WiFi (WiFi Setup)**

A four-level indicator on the Ready mode screen displays the current wireless signal strength if you are using a wireless connection.



2 **Settings**

Press to access a menu of all machine settings, (see *Settings Screen* on page 10).

3 **Shortcuts**

Press to add Shortcuts.

NOTE

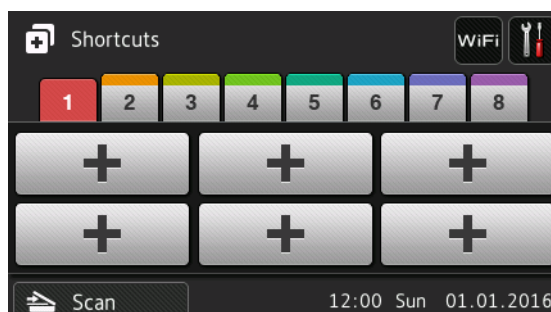

Eight Shortcut screens are available with up to six Shortcuts in each Shortcut screen. A total of 48 Shortcuts are available.

4 to Web

Press to connect the Brother machine to an Internet service (for more information, see the *Web Connect Guide*).

5 to PC

Press to access the Scan to PC function.

6 to Network

Press to access the Scan to Network function.

7 to FTP/SFTP

Press to access the Scan to FTP/SFTP function.

8 to E-mail Server

Press to access the Scan to E-mail Server function.

9 to SharePoint

Press to access the Scan to SharePoint function.

10 Apps

Press to connect the Brother machine to the Brother Apps menu (for more information, see the *Web Connect Guide*).

11 WS Scan

Press to access the WS Scan function.

The WS Scan icon appears (for more information, see the *Network User's Guide*).

12 to USB

Press to access the Scan to USB function.

13 Warning icon !



The warning icon ! appears when there is an error or maintenance message; press `Detail` to view it, and then press  to return to Ready mode.

For more information, see *Error and Maintenance Messages* on page 262.

NOTE

This product adopts the font of ARPHIC TECHNOLOGY CO., LTD.

Settings Screen

Press  (**Settings**) to check and access all the machine's settings.

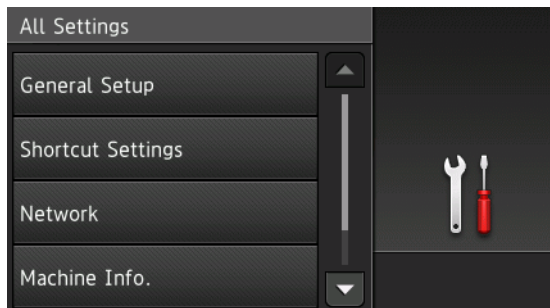

■ General Setup

Press to access the full Settings menu.

■ Shortcut Settings

Press to add Shortcuts.

For more information, see *Shortcut Settings (ADS-2800W / ADS-3600W)* on page 12.

■ Network

Press to access Network settings.

■ Machine Info.

Press to check the machine's information.

■ Initial Setup

Press to access the `Date & Time`, `Scan offset correction`, `Reset`, and `Local Language` menu.

Basic Operations

Press your finger on the Touchscreen to operate it. To display and access all the screen menus and options, swipe left, right, up, down, or press ◀▶ or ▲▼ to scroll through them.

IMPORTANT

DO NOT press the Touchscreen with a sharp object, such as a pen or stylus. It may damage the machine.

The following example shows how to change a machine setting. In this example, the Document Size setting in Scan to USB is changed to `Auto`.

- 1 Swipe left or right, or press ◀ or ▶ to display `Scan 3`.
- 2 Press `to USB`.
- 3 Press `Options`.
- 4 Press ▲ or ▼ to display `Document Size`.
- 5 Press `Document Size`.

6 Press ▲ or ▼ to display *Auto*.

7 Press *Auto*.

NOTE

Press  to go back to the previous screen or menu.

Shortcut Settings (ADS-2800W / ADS-3600W)



Add the scan and Web Connect settings you use most frequently as your Shortcuts. Later recall and apply these settings. Add up to 48 Shortcuts.

Adding Scan Shortcuts

The following settings can be included in a scan Shortcut:

Setting	to PC	to USB	to E-mail Server	to FTP / SFTP	to Network	to SharePoint
PC Name	✓	-	-	-	-	-
2-sided Scan	✓	✓	✓	-	-	-
Scan Settings	✓	-	-	-	-	-
Scan Type	✓	✓	✓	-	-	-
Resolution	✓	✓	✓	-	-	-
File Type	✓	✓	✓	-	-	-
Document Size	✓	✓	✓	-	-	-
File Name	-	✓	✓	-	-	-
File Name Style	-	✓	✓	-	-	-
File Size	-	✓	✓	-	-	-
Auto Deskew	✓	✓	✓	-	-	-
Skip Blank Page	✓	✓	✓	-	-	-
Brightness	✓	✓	✓	-	-	-
Contrast	✓	✓	✓	-	-	-
Color	-	✓	✓	-	-	-
Black and White/Gray	-	✓	✓	-	-	-
Skip blank page sensitivity	✓	✓	✓	-	-	-
Margin Settings	-	✓	✓	-	-	-
Profile name ^{*1}	-	-	-	✓	✓	✓

^{*1} The Profile name setting contains many items. For more information, see the *Network User's Guide*.

- 1 Press  Shortcuts.
- 2 Press a tab from 1 to 8.
- 3 Press  where you have not added a Shortcut.
- 4 Swipe up or down, or press ▲ or ▼ to display the type of scan you want, and then press it.

5 Do one of the following:

- If you pressed **to USB**, read the information on the Touchscreen, and then press **OK** to confirm it. Go to step **8**.
- If you pressed **to E-mail Server**, read the information on the Touchscreen, and then press **OK** to confirm it. Go to step **6**.
- If you pressed **to OCR, to File, to Image or to E-mail**, read the information on the Touchscreen, and then press **OK** to confirm it. Go to step **7**.
- If you pressed **to FTP/SFTP, to Network or to SharePoint** read the information on the Touchscreen, and then press **OK** to confirm it.
Swipe up or down, or press **▲** or **▼** to display the Profile Name, and then press it.
Press **OK** to confirm. Go to step **13**.

NOTE

To add a Shortcut for **to FTP/SFTP, to Network or to SharePoint** you must have added the Profile Name beforehand. See the *Network User's Guide: Web Based Management*.

6 Do one of the following:

- To enter an email address that is not in the Address Book, press **Manual**. Enter the email address using the keyboard on Touchscreen. (For help entering letters, see *Entering Text (ADS-2800W / ADS-3600W)* on page 285.)
Press **OK**.
- To enter an email address from the Address Book, press **Address Book**. Swipe up or down, or press **▲** or **▼** to display the email address you want, and then press it.
Press **OK**.
Confirm the email address and press **OK**. Go to step **8**.

NOTE

Press **Detail** to view the list of addresses you have entered.

7 Do one of the following:

- When the machine is connected to a computer via USB:
Press **OK** to confirm **USB** is selected as the PC Name. Go to step **13**.
- When the machine is connected to a network:
Swipe up or down, or press **▲** or **▼** to display the PC Name, and then press it. Press **OK** to confirm. Go to step **13**.

8 Press **Options**.**9** Swipe up or down, or press **▲** or **▼** to display the available settings, and then press the setting you want.**10** Swipe up or down, or press **▲** or **▼** to display the available options for the setting, and then press the option you want.
Repeat steps **9** and **10** until you have selected all the settings for this Shortcut.
Press **OK**.

- 11 Review the settings you have selected:
 - To make more changes, return to step 8.
 - When finished, press *Save as Shortcut*.
- 12 Review your settings on the Touchscreen, and then press *OK*.
- 13 Enter a name for the Shortcut. (For help entering letters, see *Entering Text (ADS-2800W / ADS-3600W)* on page 285.)
Press *OK*.
- 14 Press *OK* to save your Shortcut.



Adding Web Connect Shortcuts

The settings for these services can be included in a Web Connect Shortcut:

- Box
- Google Drive™
- Evernote®
- Evernote Business
- Dropbox
- OneDrive
- OneNote

NOTE

- Web services may have been added and service names may have been changed by the provider since this document was published.
- To add a Web Connect Shortcut, you must have an account with the web service (for more information, see the *Web Connect Guide*).

- 1 Press  *Shortcuts*.
- 2 Press a tab from 1 to 8.
- 3 Press  where you have not added a Shortcut.
- 4 Press *to Web*.
- 5 If information about the Internet connection is displayed, read and confirm it by pressing *OK*.
- 6 Swipe left or right, or press ◀ or ▶ to display the available services, and then press the service you want.
- 7 Press your account.
If the account needs a PIN code, enter the PIN.
Press *OK*.

- 8 Press the function you want.

NOTE

The available functions may vary depending on the service.

- 9 Read and confirm the displayed list of functions you have selected, and then press **OK**.
- 10 Enter a name for the Shortcut. (For help entering letters, see *Entering Text (ADS-2800W / ADS-3600W)* on page 285.)
Press **OK**.
- 11 Press **OK** to save your Shortcut.



Adding Apps Shortcuts

The settings for these services can be included in an Apps Shortcut:

- NoteScan
- Outline&Scan

NOTE

Web services may have been added and service names may have been changed by the provider since this document was published.

- 1 Press  Shortcuts .
- 2 Press a tab from 1 to 8.
- 3 Press  where you have not added a Shortcut.
- 4 Press **Apps**.
- 5 If information about the Internet connection is displayed, read the information and confirm it by pressing **OK**.
- 6 Swipe left or right, or press **◀** or **▶** to display the available apps, and then press the app you want.

NOTE

The available apps may vary depending on the service.

- 7 Press your account.
If the account requires a PIN code, enter the PIN.
Press **OK**.
- 8 Read and confirm the displayed list of apps you selected, and then press **OK**.
- 9 Enter a name for the Shortcut. (For help entering letters, see *Entering Text (ADS-2800W / ADS-3600W)* on page 285.)
Press **OK**.
- 10 Press **OK** to save your Shortcut.

Adding ID Card Shortcuts (ADS-3600W only)

- 1 Press .
- 2 Press a tab from 1 to 8 to display the Shortcut you want.
- 3 Hold down the Shortcut button.
- 4 Press `Register NFC`.

NOTE



- You cannot use the same ID card for different Shortcuts.
- To use the ID card for another Shortcut, unregister the card first, and then register it with the new Shortcut.

Changing Shortcuts

NOTE



You cannot change a Web Connect Shortcut. To change the Shortcut, you must delete it, and then add a new Shortcut.

(For more information, see *Deleting Shortcuts* on page 17 and *Adding Web Connect Shortcuts* on page 14.)

- 1 Press .
- 2 Press a tab from 1 to 8 to display the Shortcut you want to change.
- 3 Press the Shortcut you want, and then press `Options`. The settings for the Shortcut that you chose are displayed.
- 4 Change the settings for the Shortcut you chose in step 3 (for more information, see *Shortcut Settings (ADS-2800W / ADS-3600W)* on page 12).
- 5 When finished, press `OK`, and then press `Save as Shortcut`.
- 6 Press `OK` to confirm.
- 7 Do one of the following:
 - To overwrite the Shortcut, press `Yes`.
 - If you do not want to overwrite the Shortcut, press `No` to enter a new Shortcut name. Go to step 8.
- 8 To create a new Shortcut, hold down  to delete the current name, and then enter a new name. (For help entering letters, see *Entering Text (ADS-2800W / ADS-3600W)* on page 285.) Press `OK`.
- 9 Press `OK` to confirm.

Editing Shortcut Names

Edit a Shortcut name.

- 1 Press  .
- 2 Press a tab from 1 to 8 to display the Shortcut you want.
- 3 Hold down the Shortcut button.
- 4 Press `Rename`.
- 5 To edit the name, hold down  to delete the current name, and then enter a new name. (For help entering letters, see *Entering Text (ADS-2800W / ADS-3600W)* on page 285.)
Press `OK`.

Deleting Shortcuts

Delete a Shortcut.

- 1 Press  .
- 2 Press a tab from 1 to 8 to display the Shortcut you want to delete.
- 3 Hold down the Shortcut button.
- 4 Press `Delete` to delete the Shortcut that you chose in step 3.
- 5 Press `Yes` to confirm.

Recalling Shortcuts

The Shortcut settings are displayed on the Shortcut screen. To recall a Shortcut, simply press the Shortcut name.

- 1 Press  .
- 2 Press a tab from 1 to 8 to display the Shortcut you want.
- 3 Press the Shortcut.



Accessing Brother Utilities (Windows®)

1

Brother Utilities  is an application launcher that offers convenient access to all Brother applications installed on your device.

1 Launch **Brother Utilities** for your operating system:

- Windows® 7 / Windows Vista® / Windows® XP

Click  (**Start**) > **All Programs** > **Brother** >  (**Brother Utilities**).

- Windows® 8

Tap or click  (**Brother Utilities**) either on the **Start** screen or the desktop.

- Windows® 8.1

Move your mouse to the lower left corner of the **Start** screen and click  (if you are using a touch-based device, swipe up from the bottom of the **Start** screen to bring up the **Apps** screen).

When the **Apps** screen appears, tap or click  (**Brother Utilities**).

2 Select ADS-XXXXX (where XXXXX is the name of your model).

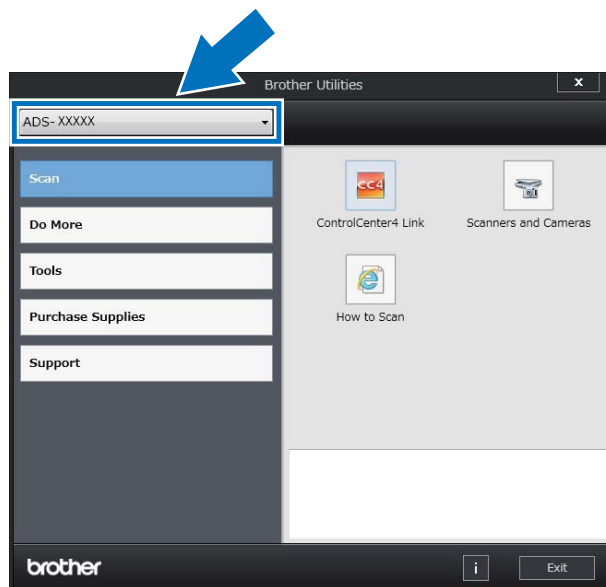

3 Select the operation you want to use.

General Setup (ADS-2400N / ADS-3000N)

Set Date&Time

- 1 Start the ControlCenter application.
 - Windows®
 - a Click the  (ControlCenter4) icon in the task tray and select **Open** from the menu. The **ControlCenter4** window appears.
 - b Click the **Device Settings** tab (the example below uses **Home Mode**).

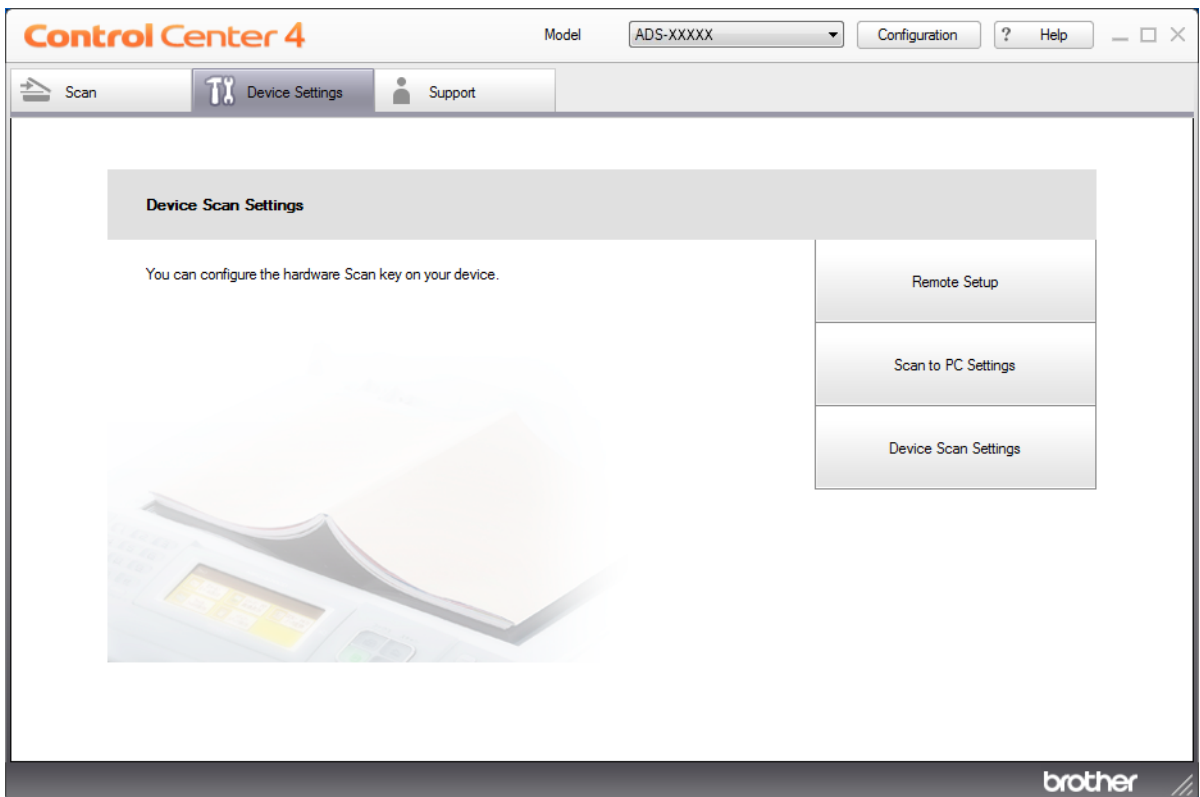

NOTE

If using **Advanced Mode**, click the  (Settings) icon to access **Device Settings**.



■ Macintosh

- a Click the  (ControlCenter2) icon in the Dock. The **ControlCenter2** window appears.
- b Click the **DEVICE SETTINGS** tab.

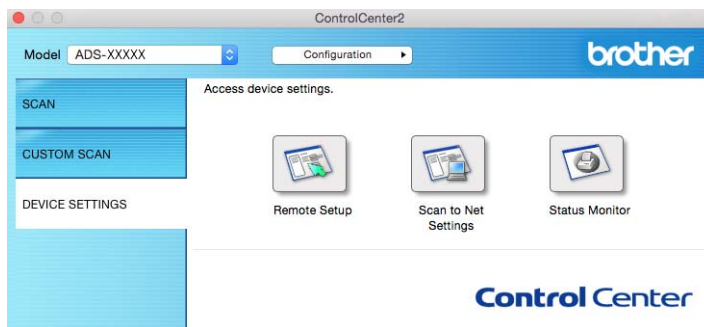

- 2 Click the **Remote Setup** button. The Remote Setup window appears.

NOTE

For more information about **Remote Setup**, see *Set Up the Brother Machine from Your Computer* on page 235.

3 Select **Initial Setup** in the folder tree.

- Windows®

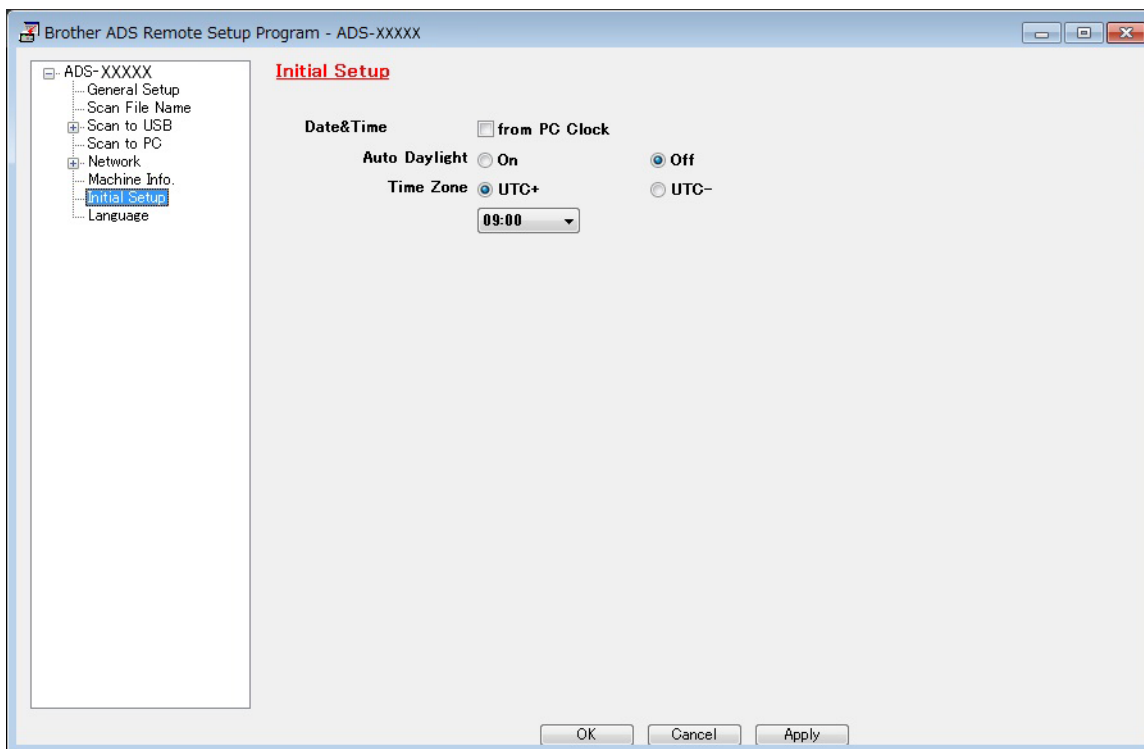

■ Macintosh

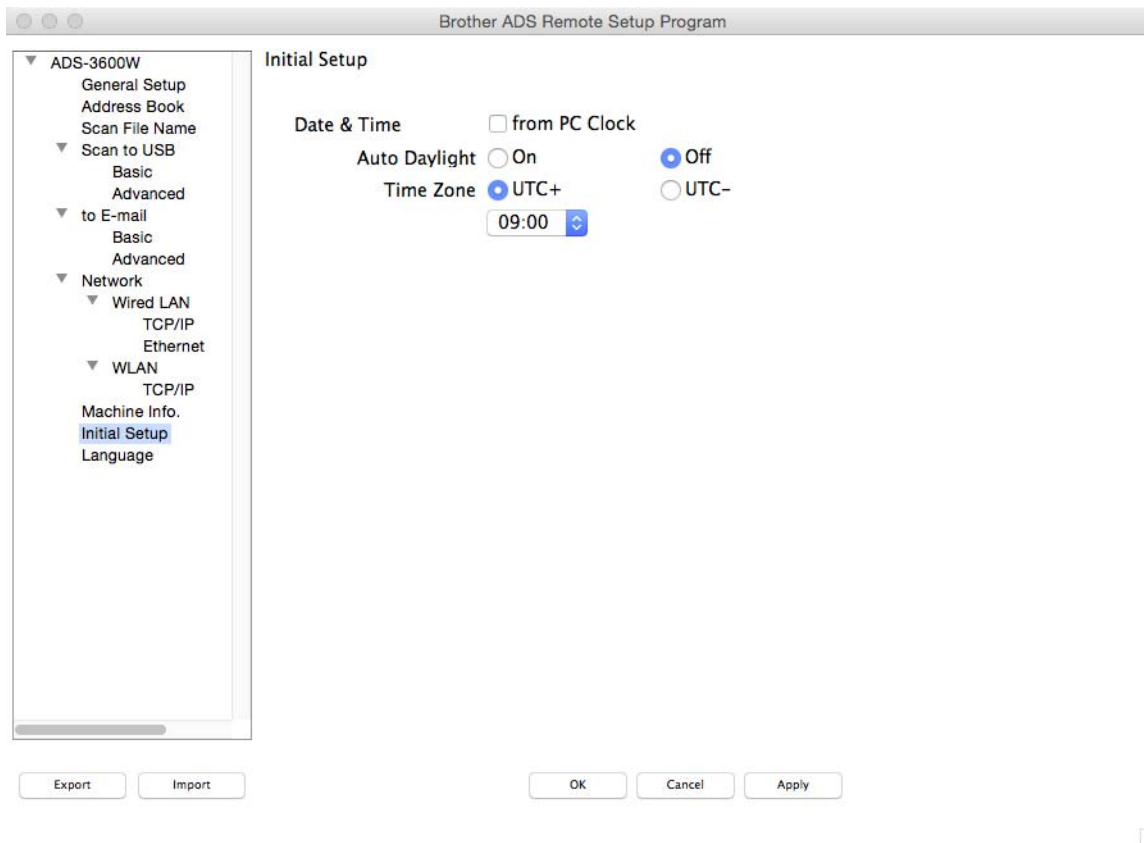

4 Select Date&Time.

If you set **Auto Daylight** to **On**, the time will be adjusted forward one hour in the spring and adjusted backward one hour in the autumn.

5 Click **OK**.

Set Sleep Time

- 1 Start the ControlCenter application.
 - Windows®
 - a Click the  (ControlCenter4) icon in the task tray and select **Open** from the menu. The **ControlCenter4** window appears.
 - b Click the **Device Settings** tab (the example below uses **Home Mode**).

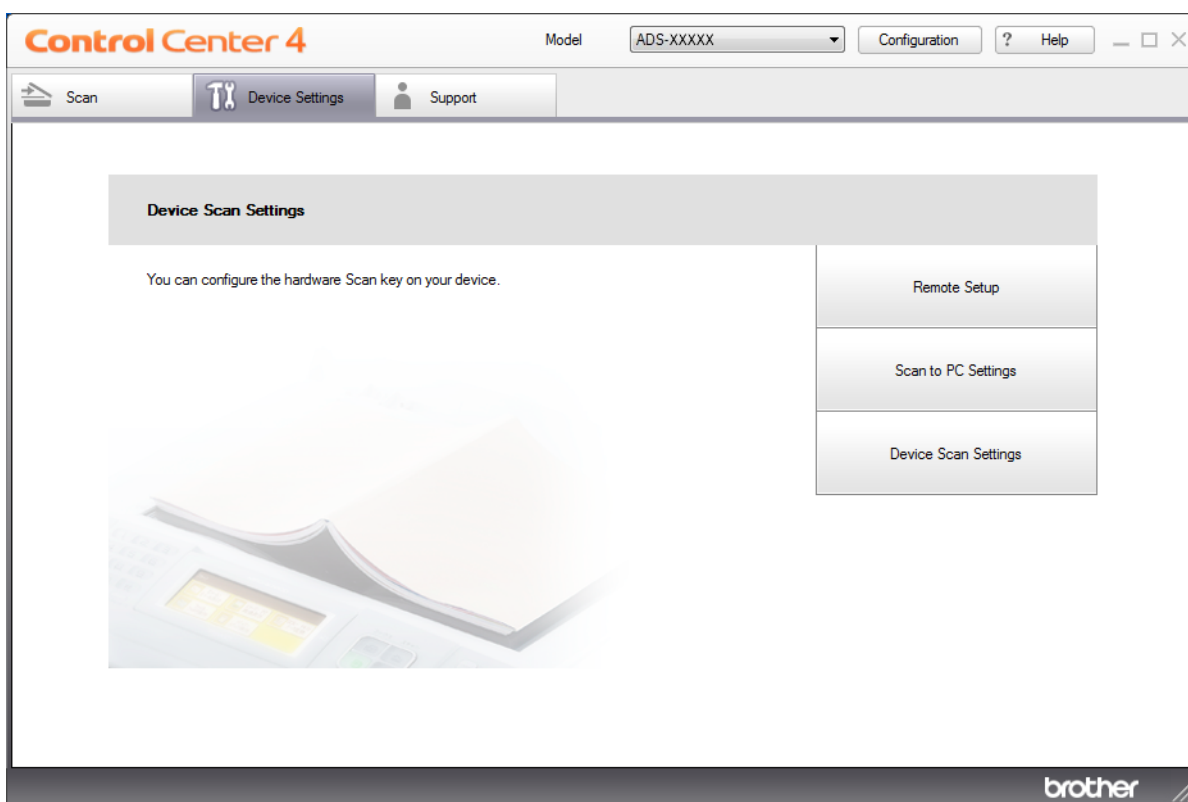

NOTE

If using **Advanced Mode**, click the  (Settings) icon to access **Device Settings**.



■ Macintosh

- a Click the  (ControlCenter2) icon in the Dock. The **ControlCenter2** window appears.
- b Click the **DEVICE SETTINGS** tab.

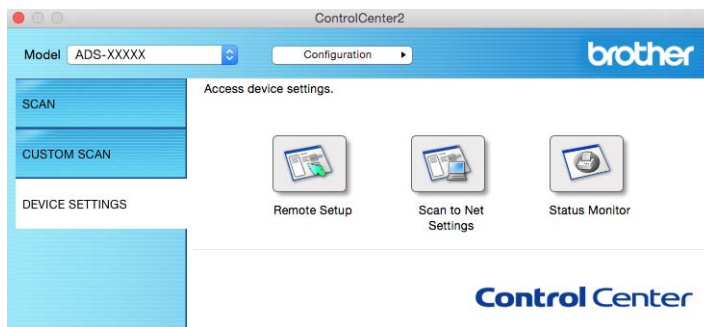

- 2 Click the **Remote Setup** button. The Remote Setup window appears.

NOTE

For more information about **Remote Setup**, see *Set Up the Brother Machine from Your Computer* on page 235.

- 3 Select **General Setup** in the folder tree.
 - Windows®

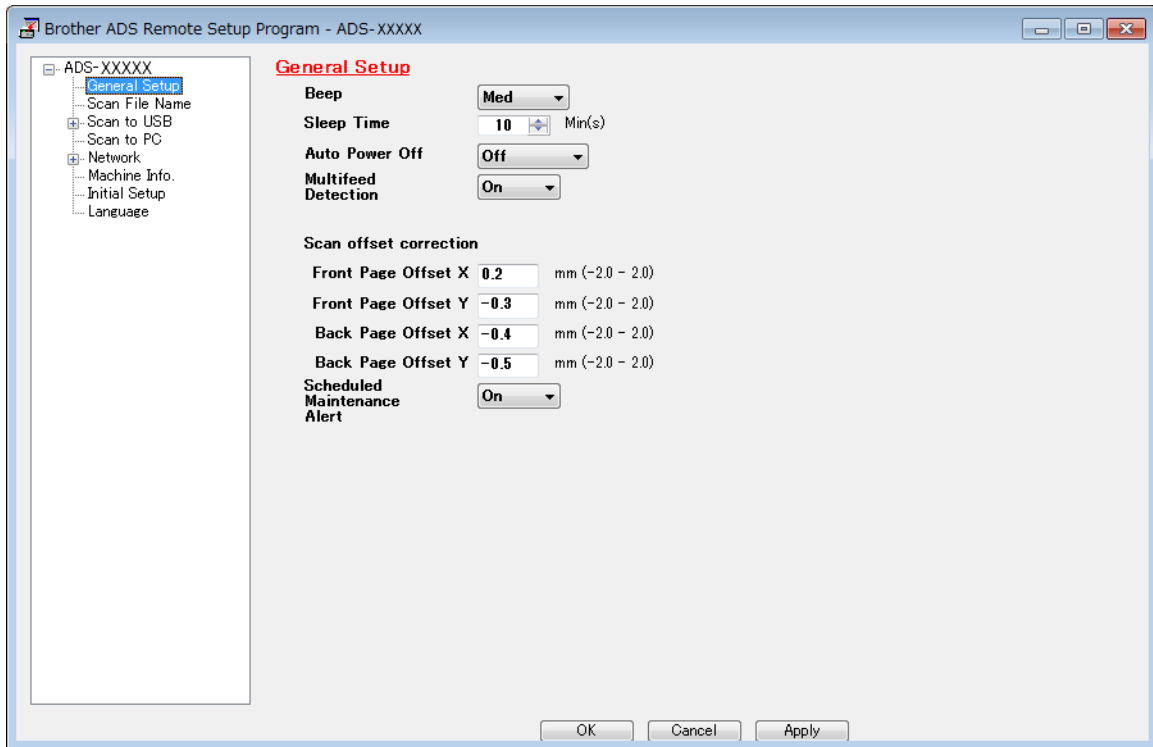

■ Macintosh

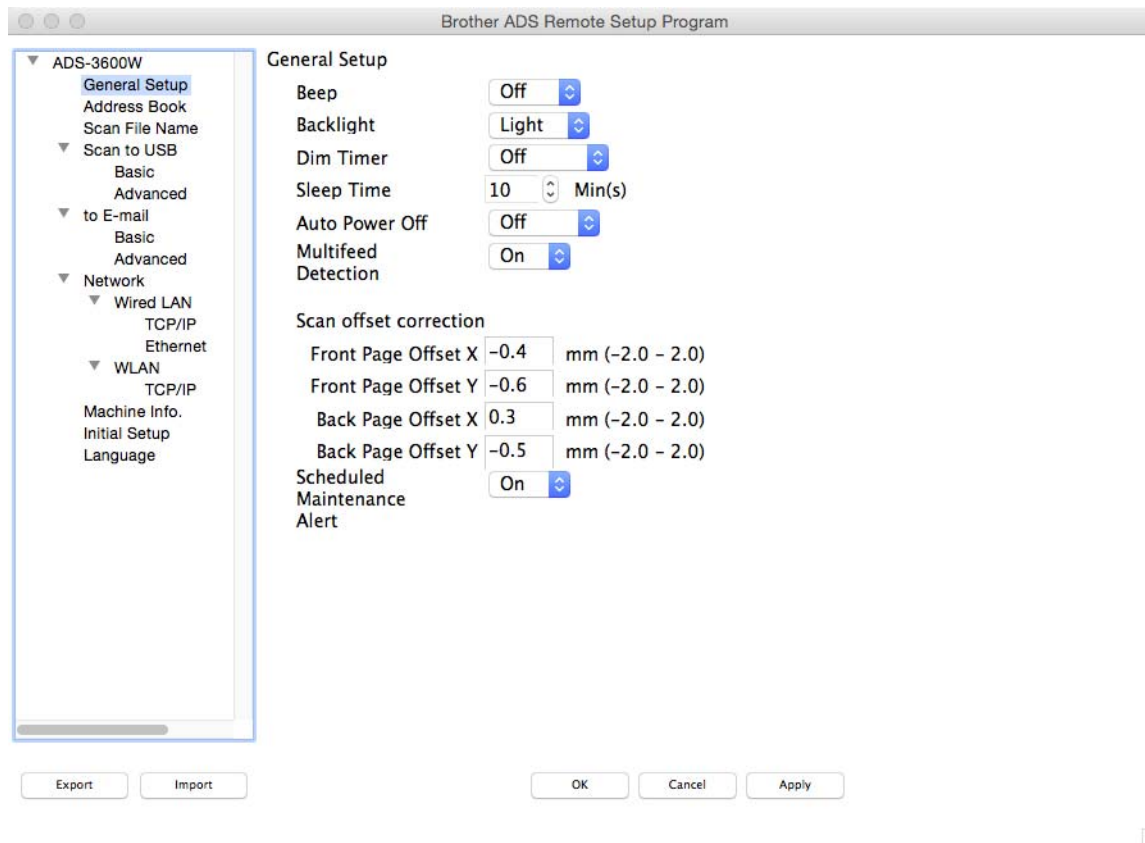

4 Select how long the machine must be idle before it goes into Sleep Time.

To exit Sleep Time, do one of the following:

- Press any key.
- Open the Top Cover.
- Load your document.
- Touch the Screen.
- Touch IC Card to the NFC reader.

5 Click **OK**.

Select Your Language

- 1 Start the ControlCenter application.
 - Windows®
 - a Click the  (ControlCenter4) icon in the task tray and select **Open** from the menu. The **ControlCenter4** window appears.
 - b Click the **Device Settings** tab (the example below uses **Home Mode**).

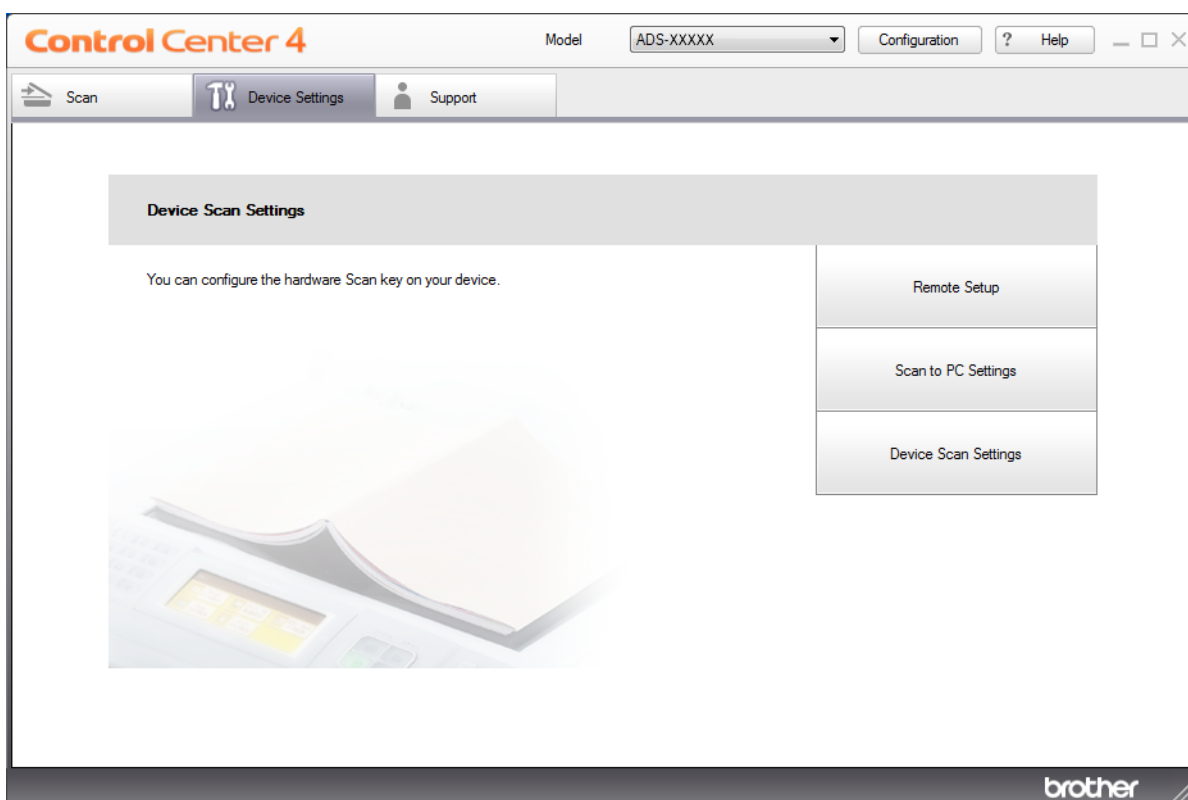

NOTE

If using **Advanced Mode**, click the  (Settings) icon to access **Device Settings**.

1



■ Macintosh

- a Click the  (ControlCenter2) icon in the Dock. The **ControlCenter2** window appears.
- b Click the **DEVICE SETTINGS** tab.

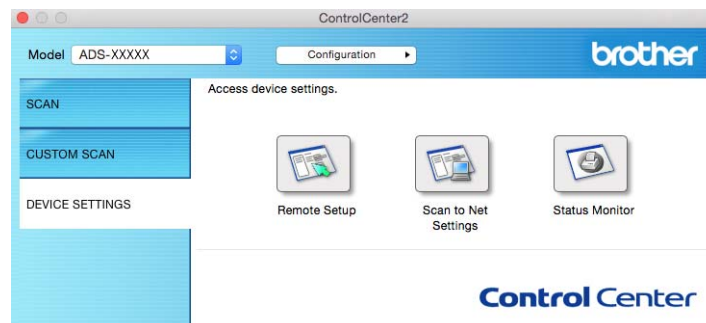

- 2 Click the **Remote Setup** button. The Remote Setup window appears.

3 Select **Language** in the folder tree.

- Windows®

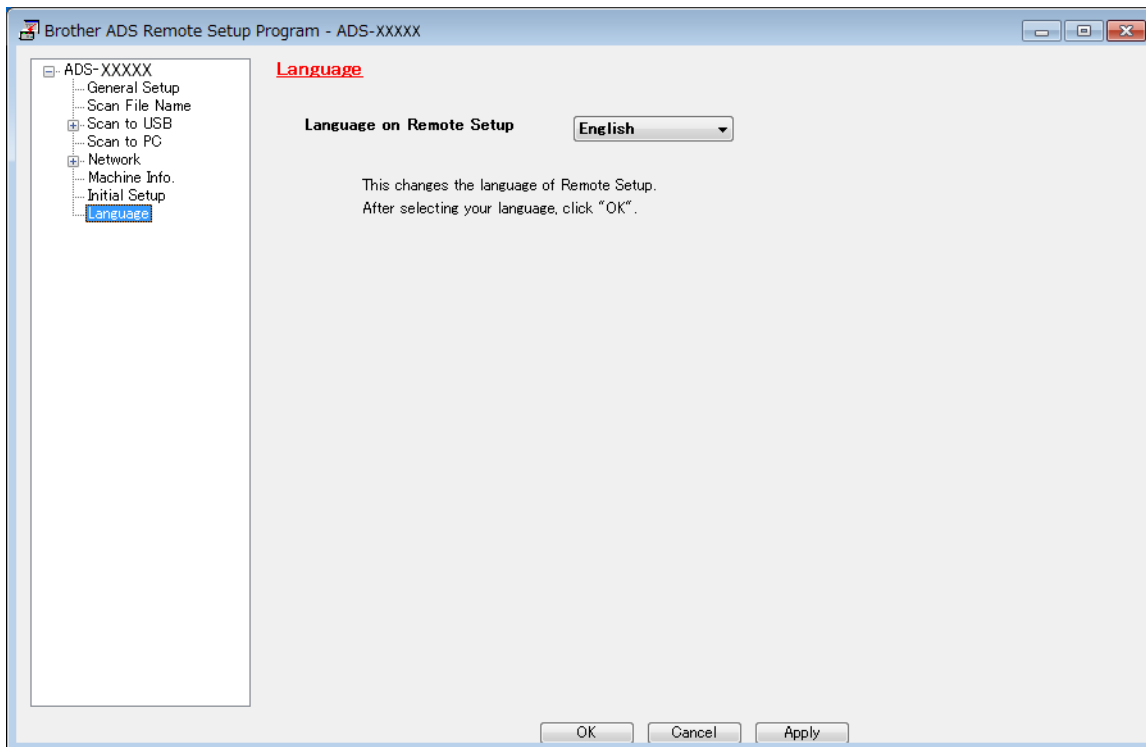

■ Macintosh

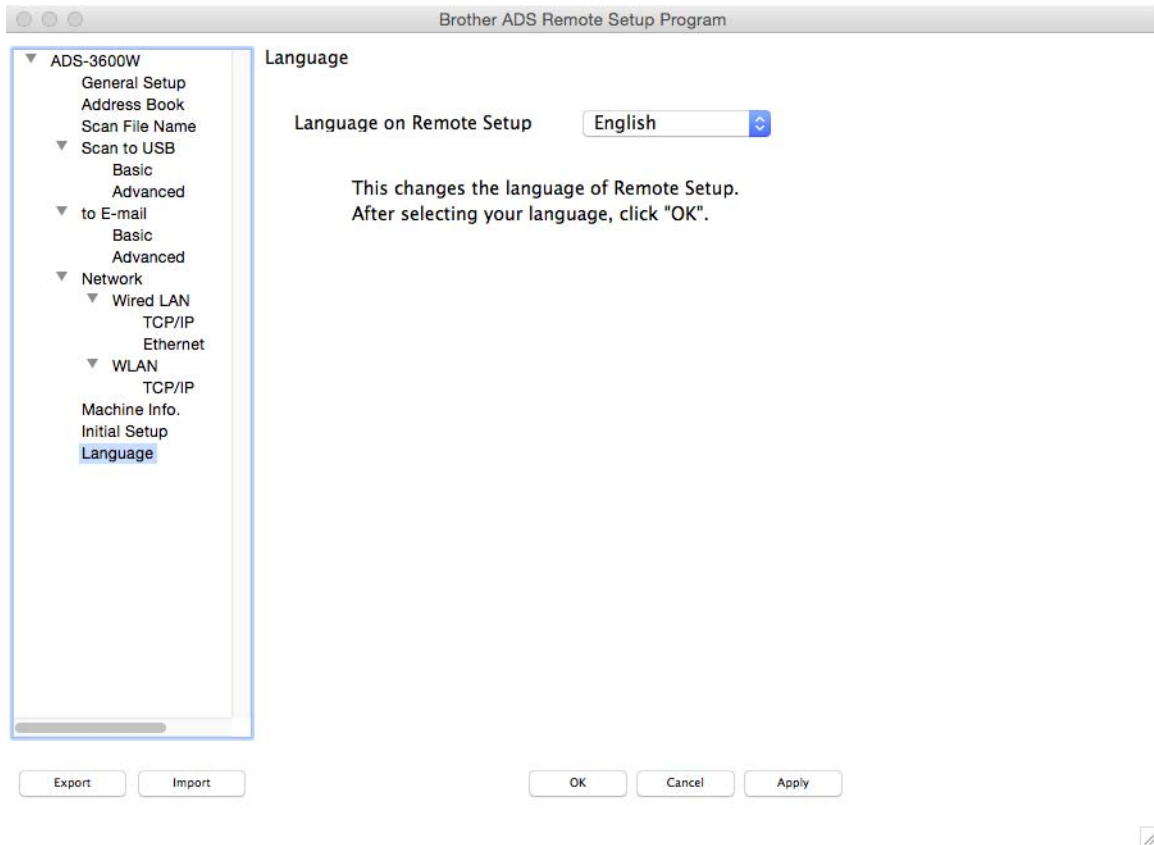

4 Select a language from the **Language on Remote Setup** drop-down list.

5 Click **OK**.

NOTE

You must close the Remote Setup window to save the language change.

Assign the Scan Feature to the Network Device Key 1-3

(ADS-2400N / ADS-3000N)

- 1 Start the ControlCenter application.
 - Windows®
 - a Click the  (ControlCenter4) icon in the task tray and select **Open** from the menu. The **ControlCenter4** window appears.
 - b Click the **Device Settings** tab (the example below uses **Home Mode**).

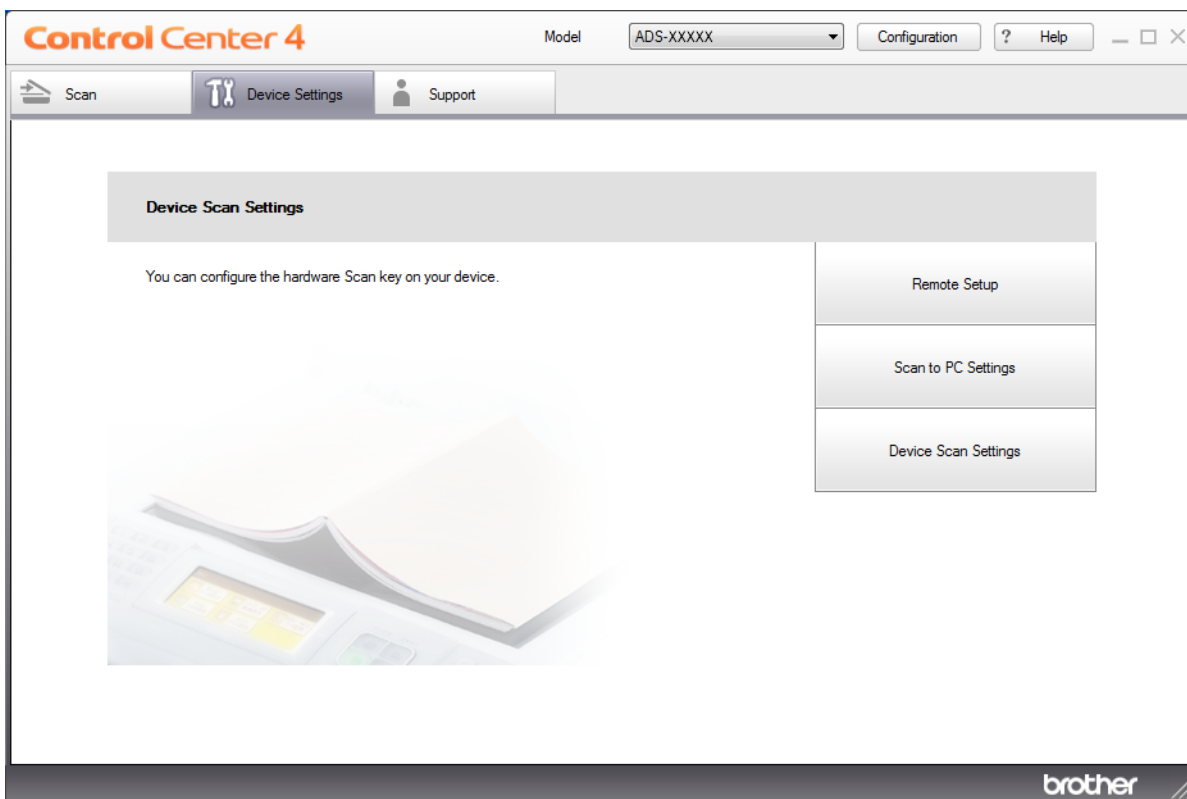

NOTE

If using **Advanced Mode**, click the  (Settings) icon to access **Device Settings**.

1



■ Macintosh

- a Click the  (ControlCenter2) icon in the Dock. The **ControlCenter2** window appears.
- b Click the **DEVICE SETTINGS** tab.

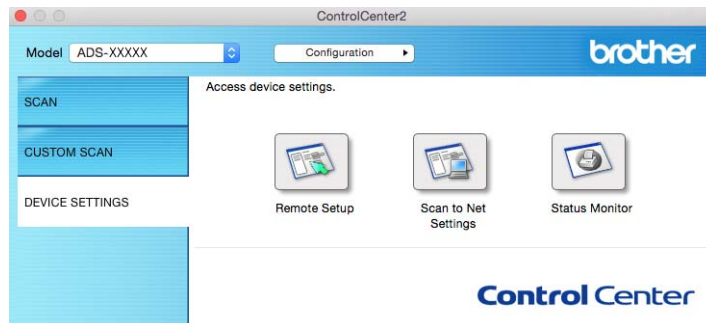



- Click the **Scan to Net Settings** button. The Web Based Management window appears.

NOTE

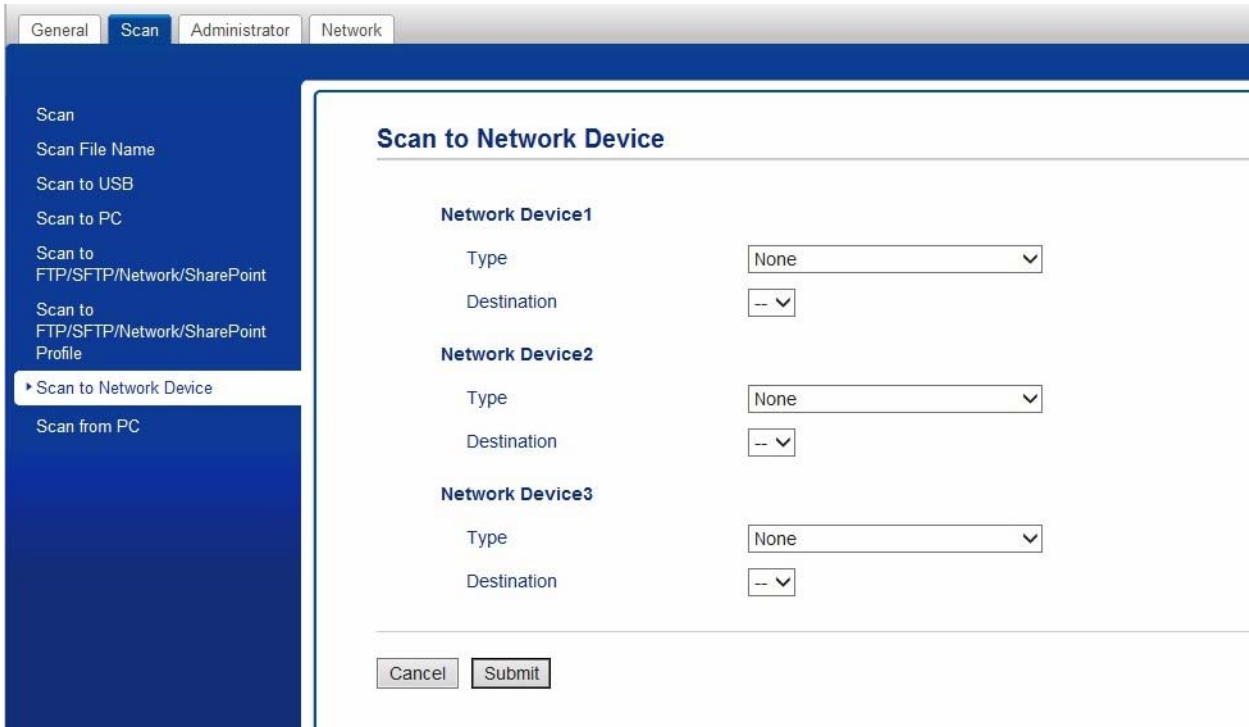
The **Scan to Network Device** option appears only when you select LAN as the connection interface at the time of installation.



- Select **Network Device 1**, **Network Device 2** or **Network Device 3** to which you want to assign the Scan to FTP feature.



Your Machine's Control Panel Icon	Setting
 1	Network Device 1
 2	Network Device 2
 3	Network Device 3

- Select **Scan to Network**, **Scan to Sharepoint**, **Scan to FTP/SFTP**, **Scan to PC**, **WS Scan** or **None** from the **Type** drop-down list for the device you have selected in 3.
- Select a profile name from the **Destination** drop-down list for the device you have selected in 3.
- Click **Submit**.

General Setup (ADS-2800W / ADS-3600W)



Set the Backlight Brightness

If you are having difficulty reading the Touchscreen, try changing the brightness setting.

- 1 Press  (**Settings**).
- 2 Press **General Setup**.
- 3 Press **LCD Settings**.
- 4 Press **Backlight**.
- 5 Press **Light, Med or Dark**.
- 6 Press .

Set the Dim Timer for the Backlight

You can set how long the Touchscreen backlight stays on after the Home Screen is displayed.



- 1 Press  (**Settings**).
- 2 Press **General Setup**.
- 3 Press **LCD Settings**.
- 4 Press **Dim Timer**.
- 5 Press **Off, 10Secs, 20Secs or 30Secs**.
- 6 Press .

Set the Home Screen



Set the Home screen to either **Scan 1-3** or **Shortcut 1-8**.

For examples of these screens, see *Touchscreen LCD* on page 6.

When the machine is idle or you press , the Touchscreen will return to the screen you have set.

- 1 Press  (**Settings**).
- 2 Press **General Setup**.
- 3 Press **Screen Settings**.
- 4 Press **Home Screen**.
- 5 Press **Scan 1-3** or **Shortcut 1-8**.
- 6 Press .

Select Your Language



- 1 Press  (**Settings**).
- 2 Press ▲ or ▼ to display Initial Setup.
- 3 Press Initial Setup.
- 4 Press Local Language.
- 5 Press ▲ or ▼ to display your language.
Press your language.
- 6 Press .

Memory Storage

Your menu settings are stored permanently and, in the event of a power failure, will not be lost. Temporary settings will be lost. If you have chosen `Set New Default` for your `Scan to USB` and `Scan to E-mail Server` preferred settings, those settings will be saved. During a power failure, the machine will retain the date and time for approximately 24 hours.

Beep Volume



When the Beep setting is `On`, the machine will beep when you press a key and make a mistake. Choose a range of beep volume levels from `Low` to `High`, or choose `Off`.

- 1 Press  (**Settings**).
- 2 Press General Setup.
- 3 Press Volume.
- 4 Press Beep.
- 5 Press Low, Med, High or Off.
- 6 Press .

Automatic Daylight Saving Time



You can program the machine to change automatically for Daylight Saving Time. It will reset itself forward one hour in the spring and backward one hour in the fall. Make sure you have set the correct date and time in the **Date & Time** setting.

Set Automatic Daylight Saving Time to **On** as follows:

- 1 Press  (**Settings**).
- 2 Press **▲** or **▼** to display **Initial Setup**.
- 3 Press **Initial Setup**.
- 4 Press **Date & Time**.
- 5 Press **Auto Daylight**.
- 6 Press **On** (or **Off**).
- 7 Press .

Sleep Time



The **Sleep Time** setting can reduce power consumption. When the machine is in **Sleep Time**, it acts as though it is turned off. Enter how long the machine must remain idle before it enters **Sleep Time**. The maximum setting is **90 Mins** and the default setting is **10 Mins**. The timer will restart if any operation is carried out on the machine.

- 1 Press  (**Settings**).
- 2 Press **General Setup**.
- 3 Press **Ecology**.
- 4 Press **Sleep Time**.
- 5 Enter the length of time the machine is idle before entering **Sleep Time**.
- 6 Press **OK**.
- 7 Press .

Auto Power Off

The Auto Power Off feature can save power consumption. Set the length of time that the machine will be in Sleep Time before it automatically powers off. When this feature is set to `Off`, you must power off the machine manually. To turn on the machine after the Auto Power Off feature has turned it Off, press .

The timer will restart if you do one of the following:

- Press .
- Press any buttons.
- Open the ADF.
- 1 Press  (**Settings**).
- 2 Press `General Setup`.
- 3 Press `Ecology`.
- 4 Press `Auto Power Off`.
- 5 Select the length of time the machine is idle before entering Auto Power Off Mode.
- 6 Press .

Auto Power Off will be activated when all of these conditions are met:

- Network cable is not plugged in.
- Wireless LAN is disabled.
- Auto Power Off setting is not set to `Off`.
- The machine has been in Sleep Time for more than the preset period.



Multifeed Detection

Multifeed is when multiple pages were fed at the same time. When this feature is set to **On**, the machine will detect a multifeed error. When a multifeed occurs, confirm that the data scanned before the multifeed has been saved, and then start scanning again at the next page or the beginning of the document.

NOTE

(Scan to USB only) (ADS-2400N / ADS-3000N)

If you selected JPEG as the file type, your Brother machine will save all data scanned *before* the multifeed error occurred.

- 1 Press  (**Settings**).
- 2 Press **General Setup**.
- 3 Press **▲** or **▼** to display **Multi-feed Detection**.
- 4 Press **Multi-feed Detection**.
- 5 Press **On** (or **Off**).
- 6 Press .



Setting Lock (ADS-2800W / ADS-3600W)

Setting Lock lets you set a password to stop other people from accidentally changing your machine's settings. Make a careful note of your password. If you forget it, you must call your administrator or Brother Customer Service to reset the passwords stored in the machine.

While Setting Lock is On, you cannot change the following settings without a password:

- General Setup
- Shortcut Settings
- Network
- Machine Info.
- Initial Setup
- Save as Shortcut in all Scan-to actions
- Set New Default and Factory Reset in to USB
- Address Book, Set New Default and Factory Reset in to E-mail Server

Set the Password

- 1 Press  (Settings).
- 2 Press General Setup.
- 3 Press Setting Lock.
- 4 Enter a four-digit number for the password using numbers 0-9.
Press OK.
- 5 Re-enter your password when the Touchscreen displays Verify:.
Press OK.
- 6 Press .

Change the Password

- 1 Press  (Settings).
- 2 Press General Setup.
- 3 Press Setting Lock.
- 4 Press Set Password.
- 5 Enter your existing four-digit password.
Press OK.

- 6 Enter a new four-digit number as the password.
Press OK.
- 7 Re-enter your new password when the Touchscreen displays *Verify:*.
Press OK.
- 8 Press .



Turn Setting Lock On/Off

If you enter the wrong password when following the instructions below, the Touchscreen displays *Wrong Password*. Enter the correct password.

Turn Setting Lock On

- 1 Press  (**Settings**).
- 2 Press *General Setup*.
- 3 Press *Setting Lock*.
- 4 Press *Lock Off→On*.
- 5 Enter the registered four-digit password, and then press OK.

Turn Setting Lock Off

- 1 Press .
- 2 Enter the registered four-digit administrator password.
Press OK.
- 3 Press .

Secure Function Lock 3.0

Secure Function Lock lets you restrict Public access to the following machine operations:

- Scan to PC
- Scan to FTP
- Scan to Network
- Scan to USB
- Scan to Web
- Scan to Email Server
- Scan to SharePoint
- Scan to WSS (Web Service Scan)
- Apps

This feature also prevents users from changing the default settings of the machine by limiting access to the machine's settings.

The administrator can set up restrictions for individual users along with a user password.

NOTE

- You can use Web Based Management or BRAdmin Professional 3 to set Secure Function Lock. (Windows[®] only.)
 - Only administrators can set limitations and make changes for each user.
 - (For ADS-3600W)
Use card authentication to switch to a different user and access operations, such as Scan to PC, Scan to FTP, and Scan to Network.
-

Before You Use Secure Function Lock 3.0

You can use a web browser to configure the Secure Function Lock settings. Before configuration, do the following:

- 1 Start your web browser.
- 2 In your browser's address bar, type your machine's IP address (or your print server name). For example: `http://192.168.1.2`. You can use the machine's LCD to find its IP address.

NOTE

- Find the machine's IP address in the Network Configuration List (see the *Network User's Guide*).
- If you are using a Domain Name System or enabling a NetBIOS name, you can enter another name such as "SharedScanner" instead of the IP address.
 - For example:
`http://SharedScanner/`
If you enable a NetBIOS name, you can use the node name.
 - For example:
`http://brwxxxxxxxxxxxxx/`
Find the NetBIOS name on the LCD, under Node Name.
- For Macintosh users, access the Web Based Management System by clicking the machine's icon on the **Status Monitor** screen. For more information, see *Monitor the Machine's Status from Your Computer (Macintosh)* on page 233.

- 3 Type an Administrator password in the **Login** box. (This is a password to log on to the machine's web page.) Click .

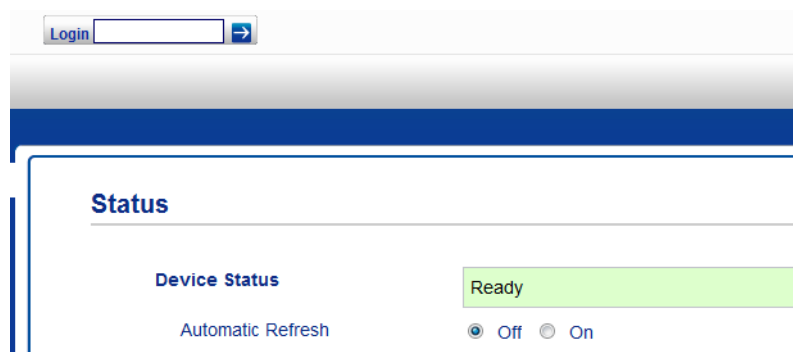

NOTE

If you are using a web browser to configure the machine's settings for the first time, set a password (see the *Network User's Guide*).

Turning Secure Function Lock On/Off

- 1 Click **Administrator**.
- 2 Click **User Restriction Function**.
- 3 Select **Secure Function Lock** or **Off**.
- 4 Click **Submit**.

NOTE

The Secure Function Lock icon is displayed at the top of the screen.



Configure Secure Function Lock 3.0 Using Web Based Management

Set up groups with restrictions and users with a password and card ID ¹. You can create up to 100 restricted groups and 100 users. Configure these settings using a web browser. To set up the web page, see *Before You Use Secure Function Lock 3.0* on page 42. Then follow these steps:

¹ For ADS-3600W.

- 1 Click **Administrator**.
- 2 Click **Restricted Functions xx-xx**.
- 3 Type an alphanumeric Group name (up to 15 characters) in the **User List / Restricted Functions** field.

User List / Restricted Functions	Scan to							
	Web	PC	Network	FTP SFTP	E-mail Server	Share Point	WS Scan	USB
Public Mode	<input checked="" type="checkbox"/>	<input checked="" type="checkbox"/>	<input checked="" type="checkbox"/>	<input checked="" type="checkbox"/>	<input checked="" type="checkbox"/>	<input checked="" type="checkbox"/>	<input checked="" type="checkbox"/>	<input checked="" type="checkbox"/>
1	<input checked="" type="checkbox"/>	<input checked="" type="checkbox"/>	<input checked="" type="checkbox"/>	<input checked="" type="checkbox"/>	<input checked="" type="checkbox"/>	<input checked="" type="checkbox"/>	<input checked="" type="checkbox"/>	<input checked="" type="checkbox"/>
2	<input checked="" type="checkbox"/>	<input checked="" type="checkbox"/>	<input checked="" type="checkbox"/>	<input checked="" type="checkbox"/>	<input checked="" type="checkbox"/>	<input checked="" type="checkbox"/>	<input checked="" type="checkbox"/>	<input checked="" type="checkbox"/>
3	<input checked="" type="checkbox"/>	<input checked="" type="checkbox"/>	<input checked="" type="checkbox"/>	<input checked="" type="checkbox"/>	<input checked="" type="checkbox"/>	<input checked="" type="checkbox"/>	<input checked="" type="checkbox"/>	<input checked="" type="checkbox"/>

- 4 In the **Scan to** and **Apps**, clear the check box to restrict access to operations.
- 5 Click **Submit**.
- 6 Click **User List xx-xx**.
- 7 In the **User List** field, type the user name (up to 20 characters).
- 8 In the **PIN Number** box, type a four-digit password.
- 9 (For ADS-3600W)
In the **Card ID** box, type the card number (up to 16 characters). ¹

¹ Use numbers from 0 - 9 and letters from A - F (not case-sensitive).

10 Select **User List / Restricted Functions** from the drop-down list for each user.

Scan Administrator Network

User List

Please enter login information for device LCD panel in the "User List". When you login from

	User List	PIN Number	User List / Restricted F
1	<input type="text"/>	<input type="text"/>	---
2	<input type="text"/>	<input type="text"/>	01
3	<input type="text"/>	<input type="text"/>	02
4	<input type="text"/>	<input type="text"/>	03
5	<input type="text"/>	<input type="text"/>	04
			05
			06
			07
			08

11 Click **Submit**.

Setting Up Card Authentication for Users (For ADS-3600W)

Before you can set up card authentication for users, you must use a web browser to create a list of users with their restricted operations.

For more information, see *Configure Secure Function Lock 3.0 Using Web Based Management* on page 44. The NFC Reader may not be able to detect when the card is in a case or cover. Always remove the card from its case or cover when you touch the card to the NFC Reader.

- 1 Use the Touchscreen to change to the restricted user mode. (For more information, see *Changing to Restricted User mode using the Touchscreen* on page 48.)
- 2 Press  XXXXX.
- 3 Press Register Card.
- 4 Touch the card to the NFC Reader. The Touchscreen displays the card ID.
- 5 Press OK.

NOTE

To change the card ID, touch the new card to the NFC Reader in step 4.

Setting Up and Changing the Public Mode

Public mode restricts the operations that are available for all users who do not have a password.

When you set up restrictions for Public mode, you must do it through Web Based Management or BRAdmin Professional 3 (Windows® only) (see the *Network User's Guide*).

- 1 Click **Administrator**.
- 2 Click **Restricted Functions xx-xx**.

- In the **Public Mode** row, clear the check box to restrict the operation in Public mode.

Scan
Administrator
Network

Restricted Functions

"User List" settings need to be configured after "Restricted Functions". "Restricted Functions" enables you to manage the restrictions per user. To restrict a function uncheck the check box.



User List / Restricted Functions		Scan to							
		Web	PC	Network	FTP SFTP	E-mail Server	Share Point	WS Scan	USB
Public Mode		<input checked="" type="checkbox"/>	<input checked="" type="checkbox"/>	<input checked="" type="checkbox"/>	<input checked="" type="checkbox"/>	<input checked="" type="checkbox"/>	<input checked="" type="checkbox"/>	<input checked="" type="checkbox"/>	<input checked="" type="checkbox"/>
1	<input type="text"/>	<input checked="" type="checkbox"/>	<input checked="" type="checkbox"/>	<input checked="" type="checkbox"/>	<input checked="" type="checkbox"/>	<input checked="" type="checkbox"/>	<input checked="" type="checkbox"/>	<input checked="" type="checkbox"/>	<input checked="" type="checkbox"/>
2	<input type="text"/>	<input checked="" type="checkbox"/>	<input checked="" type="checkbox"/>	<input checked="" type="checkbox"/>	<input checked="" type="checkbox"/>	<input checked="" type="checkbox"/>	<input checked="" type="checkbox"/>	<input checked="" type="checkbox"/>	<input checked="" type="checkbox"/>
3	<input type="text"/>	<input checked="" type="checkbox"/>	<input checked="" type="checkbox"/>	<input checked="" type="checkbox"/>	<input checked="" type="checkbox"/>	<input checked="" type="checkbox"/>	<input checked="" type="checkbox"/>	<input checked="" type="checkbox"/>	<input checked="" type="checkbox"/>

- Click **Submit**.

Switching Users

You can switch between registered restricted users and Public mode when Secure Function Lock is turned on.

Changing to Restricted User mode using the Touchscreen

- 1 Press  Public or  XXXXX.
(Where xxxxx is the user's name.)
- 2 Press `Change User`.
- 3 Swipe up or down, or press ▲ or ▼ to display your user name.
- 4 Press your user name.
- 5 Enter your four-digit user password.
Press `OK`.

NOTE

If the current ID is restricted for the operation you want, `Access Denied` appears on the Touchscreen.

Changing to Restricted User mode using the NFC Reader (For ADS-3600W)

- 1 Press  to return to the Home screen.
- 2 Touch the card to the NFC Reader.
- 3 When you have successfully logged on, the Touchscreen displays `Authorization Succeeded`.

NOTE

- Log on by touching the card to the NFC Reader even if the machine is set to Public mode or another user is logged on.
- The NFC Reader may not be able to detect when the card is in a case or cover. Always remove the card from its case or cover when you touch the card to the NFC Reader.

Changing to Public mode using the Touchscreen

- 1 Press  XXXXX.
(Where xxxxx is the user's name.)
- 2 Press `Go to Public`.

NOTE

- After a restricted user has finished using the machine, it returns to Public mode after one minute.
- If the operation you want is restricted for all users, `Access Denied` appears on the Touchscreen and the Change User screen appears. You cannot access the operation. Contact your administrator to check your Secure Function Lock settings.

Active Directory Authentication (ADS-2800W / ADS-3600W)

Active Directory Authentication restricts the use of the Brother machine. If Active Directory Authentication is enabled, the machine's control panel will be locked. The machine's settings cannot be changed until the user enters the user ID and password.

Active Directory Authentication includes the following features:

- Automatically obtains the user's email address from the LDAP server and sets it in the From field when using Scan to E-mail Server
- Automatically obtains and sets the user's home directory when using Scan to Network

Change the Active Directory Authentication setting using Web Based Management or BRAdmin Professional 3 (Windows®).

For more information about Active Directory Authentication, see the *Network User's Guide*.

Turning Active Directory Authentication Lock On/Off

- 1 Start your web browser.
- 2 In your browser's address bar, type your machine's IP address (or your print server name). For example: `http://192.168.1.2`. You can use the machine's LCD to find its IP address.
- 3 Click **Administrator**.
- 4 Click **User Restriction Function**.
- 5 Select **Active Directory Authentication** or **Off**.
- 6 Click **Submit**.

NOTE

- You must configure Active Directory Server Settings to enable Active Directory Authentication.
 - Control Panel Lock is enabled if Active Directory Server is correctly configured.
-

LDAP Authentication (ADS-2800W / ADS-3600W)

LDAP Authentication restricts the use of your Brother machine. The machine's settings cannot be changed until the user enters the user ID and password.

For more information about LDAP Authentication, see *Network User's Guide*.

Turning LDAP Authentication Lock On/Off

- 1 Start your web browser.
- 2 In your browser's address bar, type your machine's IP address (or your print server name). For example: `http://192.168.1.2`. You can use the machine's LCD to find its IP address.
- 3 Click **Administrator**.
- 4 Click **User Restriction Function**.
- 5 Select **LDAP Authentication** or **Off**.
- 6 Click **Submit**.

Acceptable Documents

NOTE

Do not load documents that contain multiple page thicknesses, paper qualities, etc.

Standard Paper

Length	2.0 in. to 14 in. (51 mm to 356 mm)	
Width	2.0 in. to 8.5 in. (51 mm to 215.9 mm)	
Weight ^{*1}	7 lb to 110 lb (27 g/m ² to 413 g/m ²)	
Thickness	2 mil to 10 mil (0.05 mm to 0.26 mm) To scan thinner documents, use the Carrier Sheet.	
Maximum Number of Pages	Up to 50 pages and less than 0.2 in. (5 mm)	
Standard Paper Size	A4	8.3 in. × 11.7 in. (210 mm × 297 mm)
	A5	5.8 in. × 8.3 in. (148 mm × 210 mm)
	A6	4.1 in. × 5.8 in. (105 mm × 148 mm)
	A7	2.9 in. × 4.1 in. (74 mm × 105 mm)
	A8	2.0 in. × 2.9 in. (52 mm × 74 mm)
	B5	7.2 in. × 10.1 in. (182 mm × 257 mm)
	B6	5.0 in. × 7.2 in. (128 mm × 182 mm)
	B7	3.6 in. × 5.0 in. (91 mm × 128 mm)
	B8	2.5 in. × 3.6 in. (64 mm × 91 mm)
	Legal	8.5 in. × 14 in. (215.9 mm × 355.6 mm)
	Mexican Legal	8.5 in. × 13.38 in. (215.9 mm × 339.9 mm)
	India Legal	8.46 in. × 13.58 in. (215 mm × 345 mm)
	Letter	8.5 in. × 11 in. (215.9 mm × 279.4 mm)

^{*1} For best performance we recommend using a carrier sheet for the following weights: 27-39 g/m².

Thick Paper

Length	2.0 in. to 11.7 in. (51 mm to 297 mm)
Width	2.0 in. to 8.5 in. (51 mm to 215.9 mm)
Weight	56 lb to 110 lb (210 g/m ² to 413 g/m ²)
Thickness	10 mil to 20 mil (0.26 mm to 0.5 mm)
Maximum Number of Pages	Less than 0.2 in. (5 mm)

Long Paper

Length	11.7 in. to 14.0 in. (297 mm to 355.6 mm)
Width	2.0 in. to 8.5 in. (51 mm to 215.9 mm)
Weight	11 lb to 56 lb (40 g/m ² to 209 g/m ²)
Thickness	2 mil to 10 mil (0.06 mm to 0.26 mm) To scan thinner documents, use the Carrier Sheet.
Maximum Number of Pages	Up to 40 pages and less than 0.16 in. (4 mm)

NOTE

- To scan a document between 14 in. to 196.9 in. (355.6 mm to 5,000 mm), select **Long Paper** as **Scan Size** or **Document Size** in the Settings dialog box.
- The maximum Length will change depending on the resolution and file format when scanning.

Plastic Card

Size (ISO)	3.37 in. × 2.13 in. (85.6 mm × 54.0 mm)
Material	Plastic (PET)
Type	Plastic card such as driver's license or store card
Thickness	Up to 55 mil (1.4 mm)
Maximum Number of Cards	Up to 5 cards and less than 0.2 in. (5.0 mm)

NOTE

A plastic card can be scanned and saved to your computer as an image file. Select the **Plastic Card Mode** check box in the Settings dialog box.

Carrier Sheet

Thickness	Total thickness of no more than 22.5 mil (0.6 mm) (one 11.25 mil (0.3 mm) document plus the Carrier Sheet)
Maximum Number of Pages	1 page

NOTE

A Carrier Sheet can be used when saving the scanned image to your computer. The Carrier Sheet cannot be used when scanning to a USB flash drive. Select the **Carrier Sheet Mode** check box in the Settings dialog box.

Unacceptable Documents

The following types of documents may not be scanned successfully:

- Documents with a carbon sheet attached
- Documents written in pencil
- Documents of uneven thickness, such as envelopes
- Documents with large wrinkles or curls
- Documents that use tracing paper
- Documents that use coated paper
- Photographs (photographic paper)
- Documents printed on perforated paper
- Documents printed on unusually-shaped paper (not square or rectangle)
- Documents with photos, notes, or stickers affixed to them
- Documents that use carbonless paper
- Documents that use loose-leaf paper or any paper with holes in it
- Documents with paper clips or staples
- Documents with wet ink
- Fabrics, metallic sheets, or overhead projector sheets
- Glossy or mirrored media
- Documents that exceed recommended thicknesses

IMPORTANT

- Carbonless paper contains chemical substances that may harm the rollers. If paper jams occur frequently, clean the Reverse Roller and Pick Up Roller. (See *Clean the Scanner and Rollers* on page 241.) The life of the Reverse Roller and Pick Up Roller may end sooner compared to scanning wood-containing paper.
 - When scanning wood containing paper, the life of the Reverse Roller and Pick Up Roller may end sooner compared to scanning wood-free paper.
 - The Reverse Roller and Pick Up Roller be damaged when a photo/sticky note on the document touches these parts during scanning.
 - The surface of the document may be damaged when scanning glossy paper such as photographs.
 - The light of the LED reflects brightly when scanning glossy paper.
-

Loading Capacity

The number of sheets that can be loaded in the Paper Guides is determined by the paper size and paper weight. See the graph below.

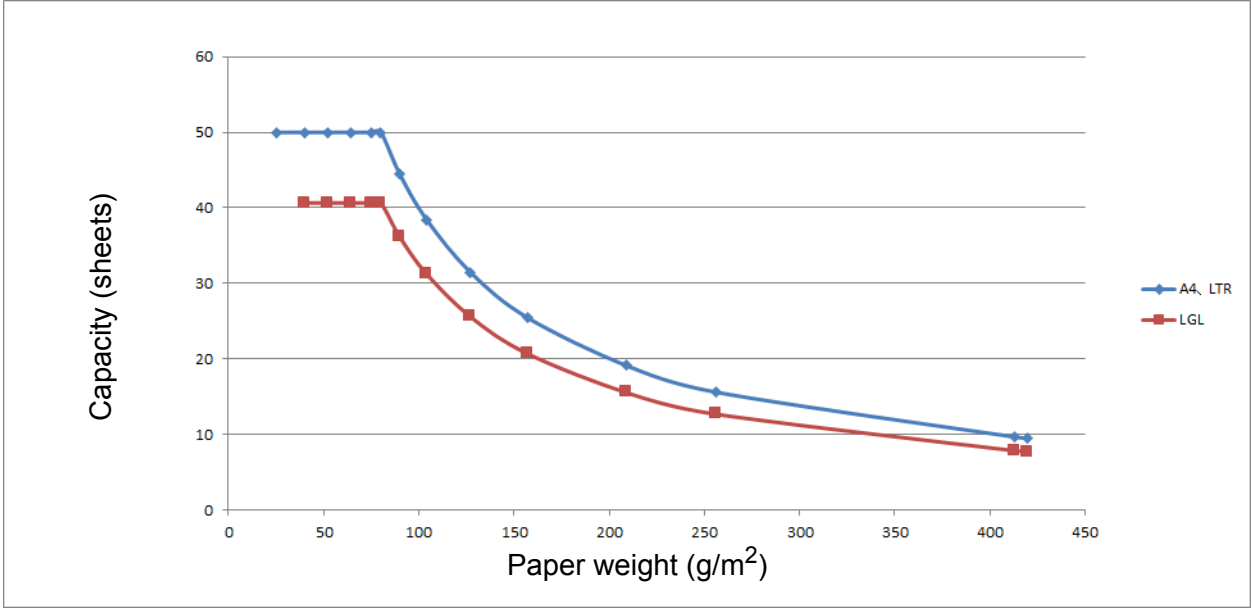

Capacity (Sheets) vs Paper Type

Unit	Paper Size	25	40	52	64	75	80	90	104	127	157	209	256	413
Capacity (Sheets)	A4, LTR	50	50	50	50	50	50	44	38	31	25	19	16	10
	LGL	-	41	41	41	41	41	36	31	26	21	16	13	8

Area Not to be Perforated

An error may occur if there are punched holes in the area shaded in light blue in the following figure.

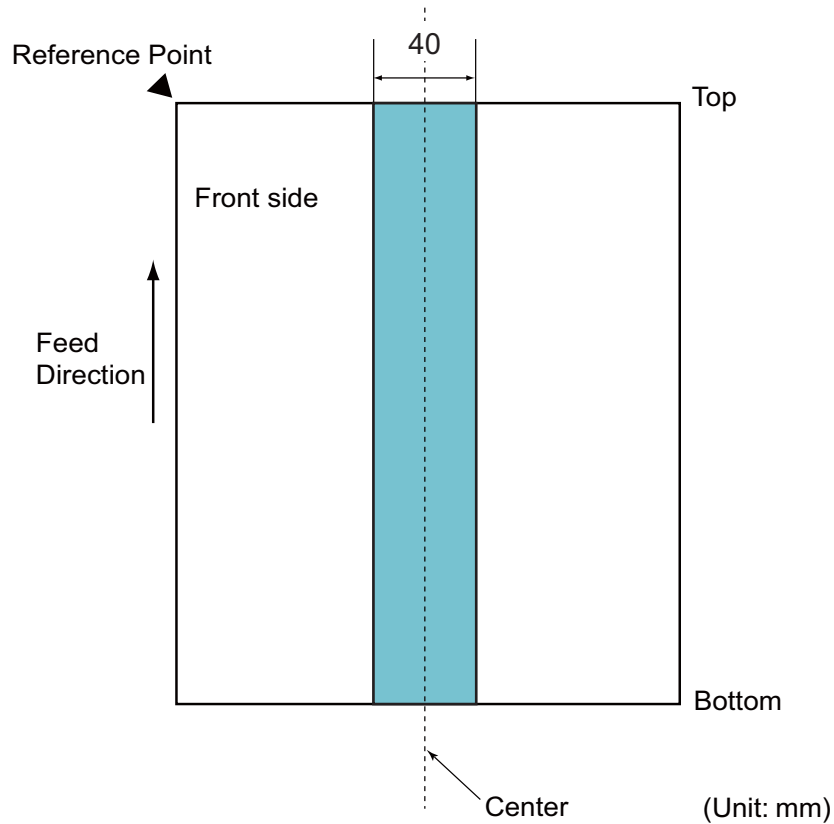

NOTE

The document must be centered at the Pick Up Roller.

Conditions for Multifeed Detection

A multifeed is an error when two or more sheets are fed through the ADF at once or when a different document length is detected.

Multifeed detection is performed by either checking the overlapping of documents, length of the documents, or a combination of both.

The following conditions are required for an accurate detection:

- Load documents of the same paper weight in the Paper Guides.
- Paper weight must be between 7 and 110 lb (27 to 413 g/m²).
- Do not punch holes within 1.57 in. (40 mm) of the document's center.
- Do not attach other documents within 1.57 in. (40 mm) of the document's center.
- The document must be centered at the Pick Up Roller.
- Scanning thick documents, such as plastic cards, may cause a false multifeed error. If this happens, disable multifeed detection.

Scanning a Mixed Batch

Check the following conditions when scanning a batch of documents with different paper weights, friction coefficients, or sizes.

Test a few sheets first to check if the documents can be scanned.

■ Paper direction

Align the direction of the paper fiber with the feed direction.

■ Paper weight

Use the following paper weights: 11 to 110 lb (40 to 418 g/m²)

■ Friction coefficient

We recommend using the same type of paper from the same manufacturer.

Mixing paper from different manufacturers and brands affects the feeding performance as the difference in the friction coefficient increases.

We recommend using the following friction coefficients: 0.35 to 0.60 (reference value for paper friction coefficient)

■ Document position

Use paper sizes that fits the 1.54 in. (39 mm) width of the center Pick Up Roller.

■ Paper size

When scanning a mixed batch of different paper sizes, the documents are more likely to skew while feeding because the paper guides do not touch every sheet. Scanned images may have missing portions and document jams may occur.

IMPORTANT

Check the scanned images to make sure they are straight and complete.

■ Documents that cannot be scanned in a mixed batch

The following types of documents cannot be mixed in the same batch:

- Carbonless paper
- Bond paper
- Perforated documents
- Thermal paper
- Carbon-backed paper
- OHP film
- Tracing paper
- Synthetic paper
- Bent or damaged documents
- Thin paper (less than 40g/m²)

Carrier Sheet Recommendations

- Documents with a carbon sheet attached
- Documents written in pencil
- Documents narrower than 2.0 in. (51 mm) wide
- Documents shorter than 2.76 in. (70 mm) long
- Pages thinner than 3 mil (0.08 mm)
- Documents of uneven thickness, such as envelopes
- Documents with large wrinkles or curls
- Bent or damaged documents
- Documents that use tracing paper
- Documents that use coated paper
- Photographs (photographic paper)
- Documents printed on perforated paper
- Documents printed on unusually-shaped paper (not square or rectangle)
- Documents with photos, notes, or stickers affixed to them
- Documents that use carbonless paper
- Documents that use loose-leaf paper or any paper with holes in it

CAUTION

To avoid cutting yourself, do not slide or scrape your hand along the edge of the Carrier Sheet.

IMPORTANT

- To avoid warping, do not place the Carrier Sheet in direct sunlight or in an area subject to high temperatures and high humidity.
- To avoid damaging the Carrier Sheet, do not bend or pull it. If the Carrier Sheet becomes damaged, it may not be suitable for scanning, and should not be used.

Notes for Using Carrier Sheets

- To avoid document jams, do not load the Carrier Sheet upside down. See the instructions printed on the Carrier Sheet itself for more information or see *Load Documents* on page 60.
- To avoid document jams, do not put several small documents into the Carrier Sheet at the same time. Insert only one document into the Carrier Sheet at a time.
- Do not write on the Carrier Sheet, as the writing may be seen in scanned documents. If the Carrier Sheet becomes dirty, wipe it with a dry cloth.
- Do not leave documents in the Carrier Sheet for extended periods time; the printing on the documents may bleed through onto the Carrier Sheet.

IMPORTANT

If you use any of the Unacceptable Documents and damage your Brother machine, it may not be covered under warranty.

3

Scan Preparation

Set Up Your Scanner

Attach the Extendable ADF (Automatic Document Feeder) ①. Pull it up to support your document. Pull out the Extendable Output Tray ② and position it to the length of your document.

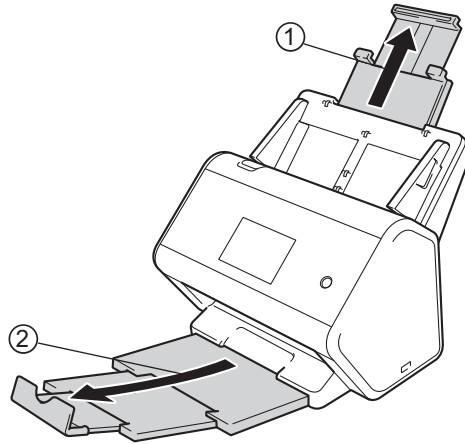

Load Documents

The Automatic Document Feeder (ADF) can hold up to 50 pages and feed each sheet individually. Use 20 lb (80 g/m²) paper and always fan the pages before placing them in the ADF.

IMPORTANT

- Make sure documents with ink or correction fluid are completely dry.
- DO NOT pull on the document while it is feeding.
- DO NOT use paper that is curled, wrinkled, folded, ripped, stapled, paper clipped, pasted or taped.
- DO NOT use cardboard or fabric.

Standard-size Documents

- 1 Adjust the Paper Guides ① to fit the width of your document.

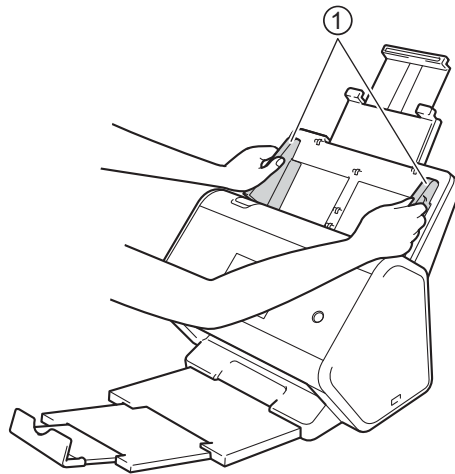

- 2 Fan the pages several times along both the long edge and the short edge.

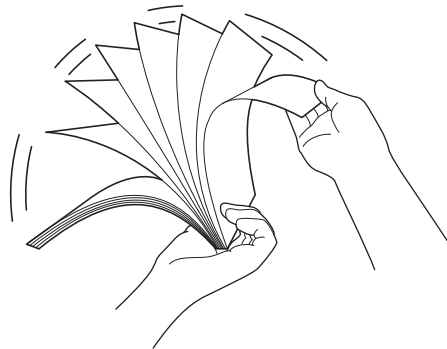

- 3 Align the edges of the pages.

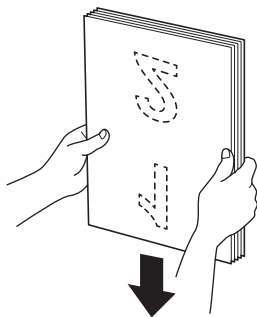

- 4 Place your document, **face down, top edge first** in the ADF between the Guides until you feel it touch the inside of the machine gently. Feed thin pages slowly and gently to keep the edge from folding.

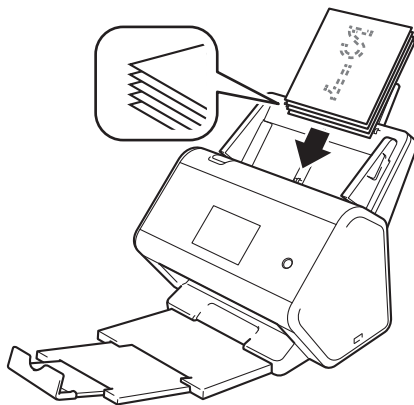

Business Cards

- 1 Adjust the Paper Guides ① to fit the width of your document.

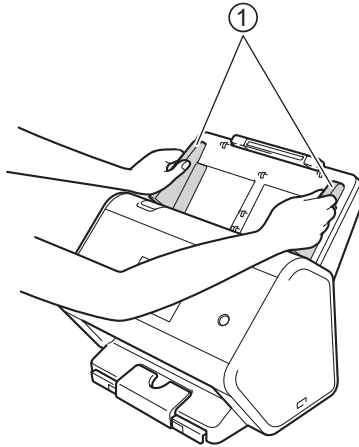

- 2 Please pull the output tray out until you see the engraved card mark.

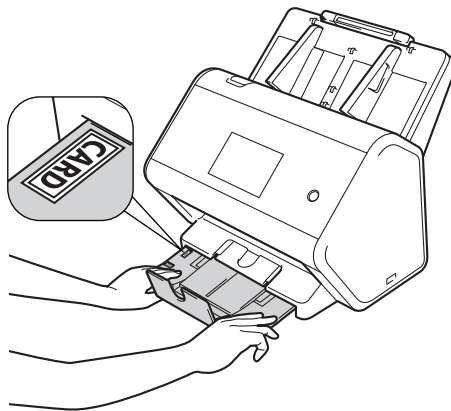

- 3 Place your card, **face down** and **top edge first** in the ADF between the Guides until you feel it touch the inside of the machine.

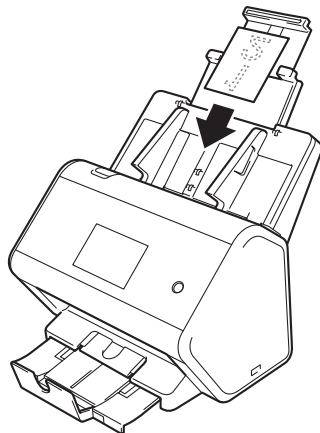

NOTE

- You can load up to 20 to 25 business cards (total thickness less than 0.2 in. (5 mm) at a time).
-

Plastic Cards

- 1 Adjust the Paper Guides ① to fit the width of your document.

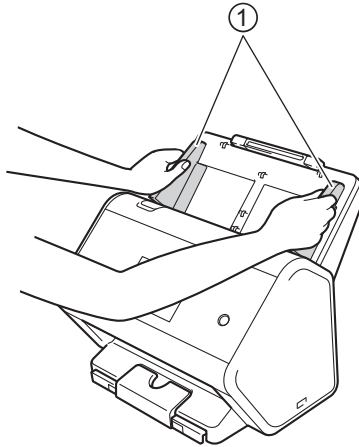

- 2 Place your card, **face down** and **top edge first** in the ADF between the Guides until you feel it touch the inside of the machine.

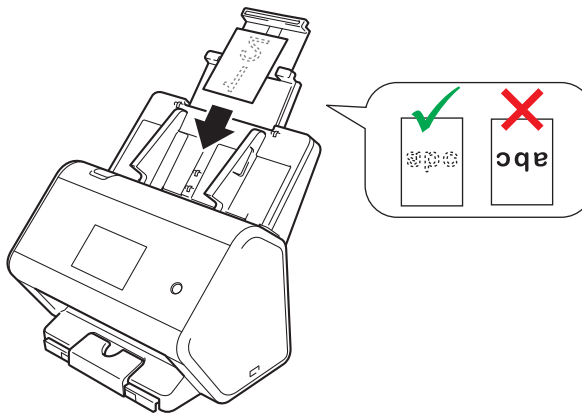

NOTE

- You can load up to 5 plastic cards (total thickness less than 0.2 in. (5.0 mm)) at a time.
- Certain types of plastic cards may be scratched when scanned.
- Rigid cards may not be fed properly.
- If the surface of the card is dirty with grease marks (for example, fingerprints) and such, perform scanning after wiping the dirt off.
- Scanning plastic cards can be falsely detected as a multifeed. In that case, to scan documents successfully, disable multifeed detection.

Documents Longer than Standard Size

Make sure documents with ink or correction fluid are completely dry.

- 1 Adjust the Paper Guides ① to fit the width of your document.

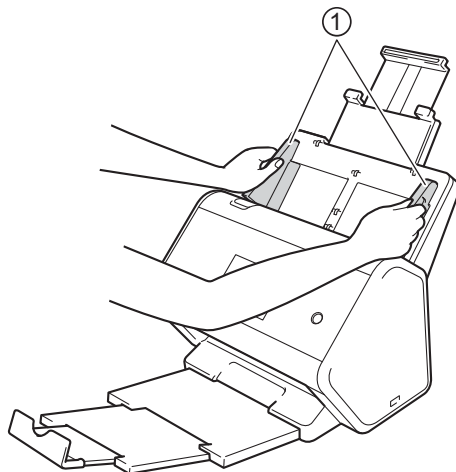

- 2 Place your document, **face down, top edge first** in the ADF between the Guides until you feel it touch the inside of the machine.

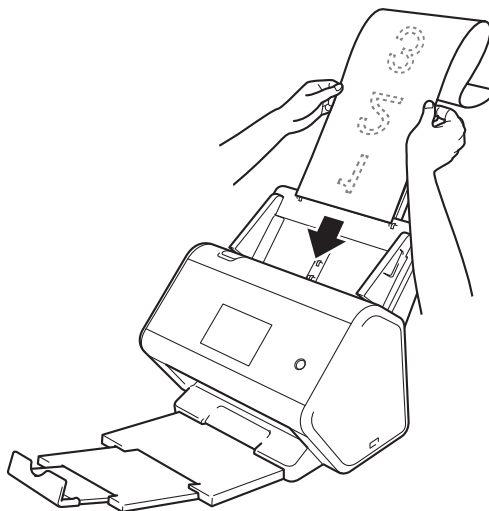

NOTE

- Load only one document at a time.
 - Support the document with your hand if the document is longer than the extended ADF.
-

Documents Printed on Non-standard Size Paper

Make sure documents with ink or correction fluid are completely dry.

- 1 Fold your document in half and insert it into the Carrier Sheet, so the document (1) and carrier sheet header (2) are both **face up**.

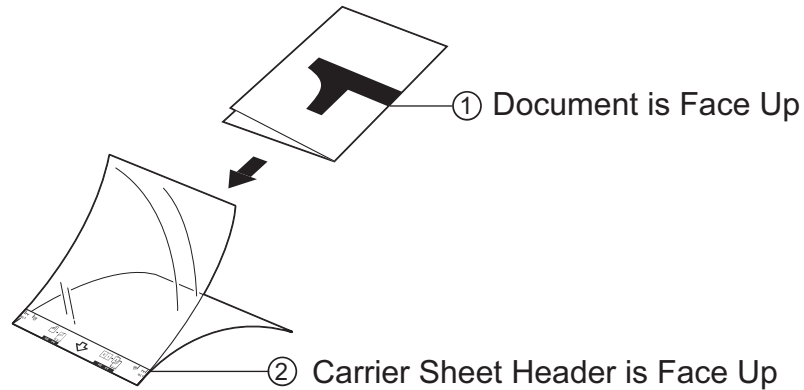

NOTE

Insert the document in the center of the Carrier Sheet and align the top of the document with the top of the Carrier Sheet.

- 2 Adjust the Paper Guides (1) to fit the width of the Carrier Sheet.

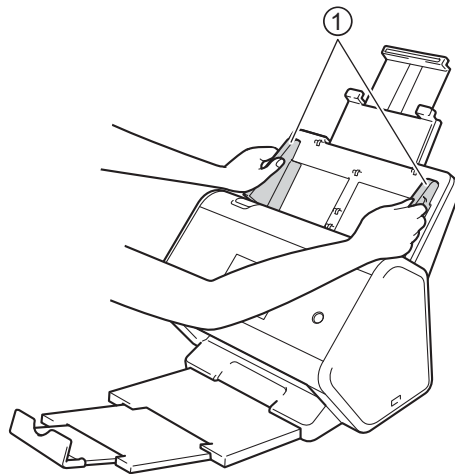

- 3 Place the Carrier Sheet **face down** in the ADF between the Guides until you feel it touch the inside of the machine.

NOTE

To reduce the white space in the center of a scanned page, be sure to position the folded edge of the original document close to the edge of the Carrier Sheet.

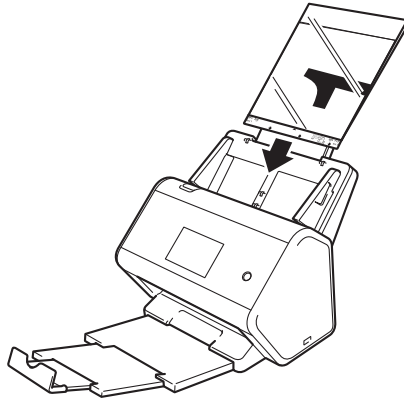

Documents with Facing Pages

Follow the steps of *Documents Printed on Non-standard Size Paper* on page 66.

Receipts, Clippings, Photos, and Other Documents

Make sure documents with ink or correction fluid are completely dry.

- 1 Insert the document into the Carrier Sheet.

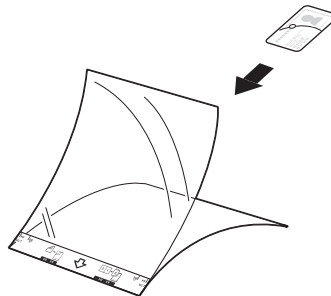

NOTE

- Insert the document in the center of the Carrier Sheet and align the top of the document with the top of the Carrier Sheet.
- If the receipt is longer than the Carrier Sheet, fold the receipt in two places so that it overlaps when you insert it into the Carrier Sheet.

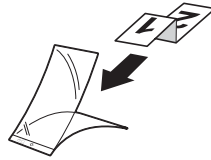

- 2 Adjust the Paper Guides ① to fit the width of the Carrier Sheet.

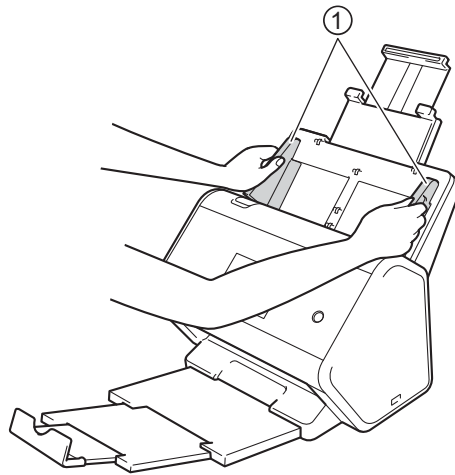

- 3 Place the Carrier Sheet in the ADF between the Guides until you feel it touch the inside of the machine.

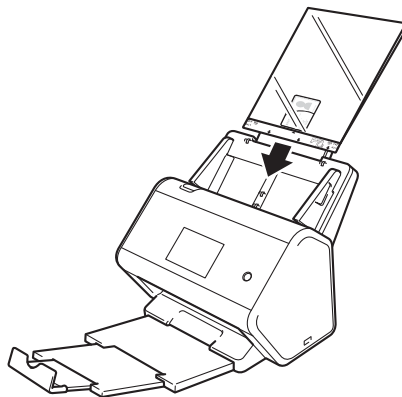

4

Prepare Your Network for Scanning with Your Computer

Before Scanning

Before scanning, confirm the following:

- Make sure you have installed the Brother software (MFL-Pro Suite) by following the steps in the Quick Setup Guide.
- If your Brother machine is connected via cable, make sure that the interface cable is physically secure.

Before Network Scanning

Network License (Windows®)

This product includes a computer license for up to two users.

This license supports the installation of the MFL-Pro Suite software, including Nuance™ PaperPort™ 14SE, on up to two computers on the network.

Configure Network Scanning for Windows®

If you are using a different machine than the one that was originally registered on your computer during the installation of MFL-Pro Suite software, follow the steps below:

1 Do one of the following:

- Windows® 7, Windows® 8 and Windows® 8.1

Click  (**Brother Utilities**) on your desktop, and then click the drop-down list and select your model name (if not already selected). Click **Scan** in the left navigation bar, and then click **Scanners and Cameras**.

- Windows® XP, Windows Vista®

Click  (**Start**) menu, select **Control Panel** click **Scanners and Cameras**.

2 Do one of the following:

- Windows® XP

Right-click the Scanner Device icon and choose **Properties**.

The Network Scanner Properties dialog box appears.

- Windows Vista®, Windows® 7, Windows® 8 and Windows® 8.1

Click the **Properties** button.

NOTE

(Windows Vista®, Windows® 7, Windows® 8 and Windows® 8.1)

If the **User Account Control** screen appears, do the following:

- For users who have administrator rights: Click **Continue** or **Yes**.

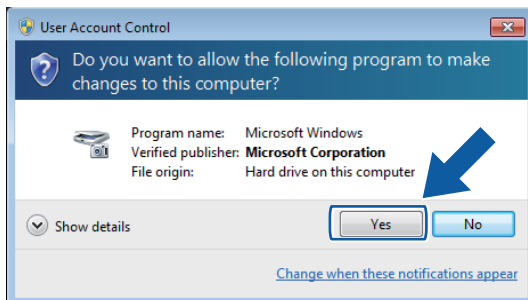

- For users who do not have administrator rights: Type the administrator password and click **OK** or **Yes**.

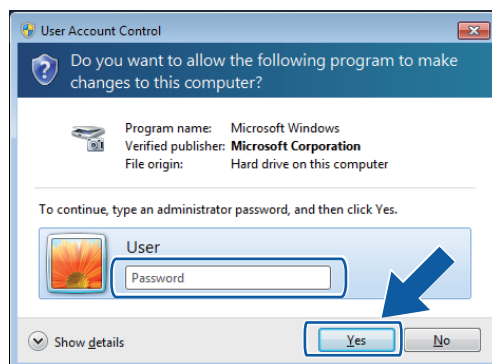

- 3 Click the **Network Setting** tab and choose the appropriate connection method.

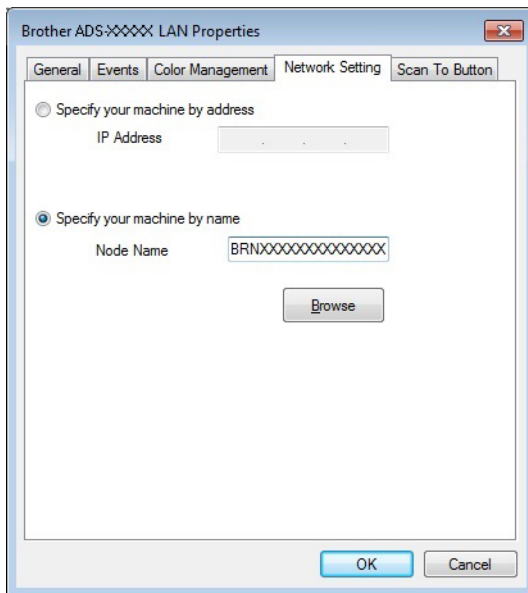

Specify your machine by address

Type the IP address of the machine in **IP Address**, and then click **Apply** or **OK**.

Specify your machine by name

- 1 Type the machine node name in **Node Name**, or click **Browse** and choose the machine you want to use.
- 2 Click **OK**.

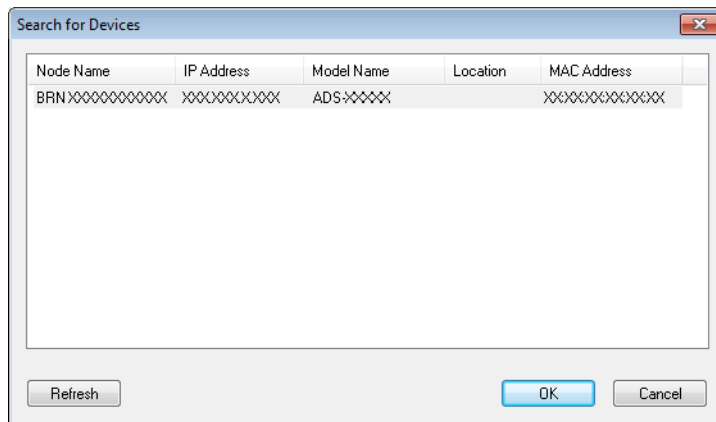

- 4 Click the **Scan To Button** tab and type your computer name in the **Display Name** field. The Touchscreen displays the name you enter. The default setting is your computer name. Enter any name that you like.

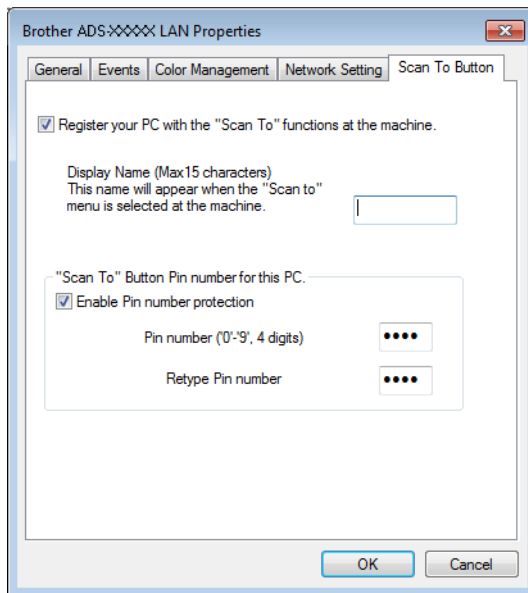

- 5 (ADS-2800W / ADS-3600W)
To avoid receiving unwanted documents, type a four-digit PIN in the **Pin number** and **Retype Pin number** fields.
To send scanned data to a computer protected by a PIN, the Touchscreen prompts you to enter the PIN before the document can be scanned and sent to the computer.

Configure Network Scanning for Macintosh

If you followed the network installation steps in the Quick Setup Guide, your Brother machine was added to your network automatically. Otherwise, add it to your network using ControlCenter2.

To use the machine as a network scanner, the machine must be configured with a TCP/IP address. You can add or change the address settings from the Control Panel.

- 1 Click the  (ControlCenter2) icon in the Dock. The **ControlCenter2** window appears.



- 2 Select **Other** from the **Model** pop-up menu. The **Device Selector** window appears.

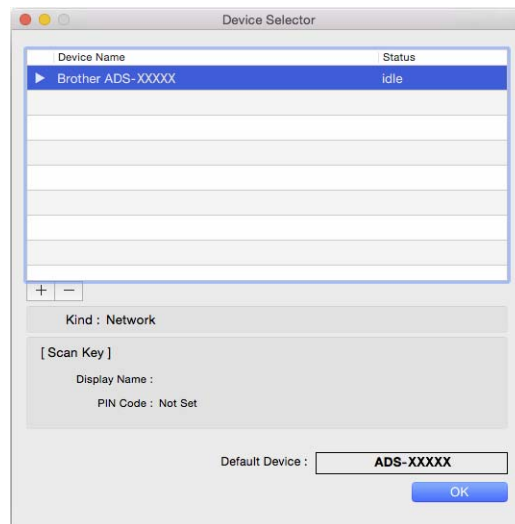

- 3 Click the **+** button. The setting window appears.

- 4 Select your machine from the list and click **Add**.

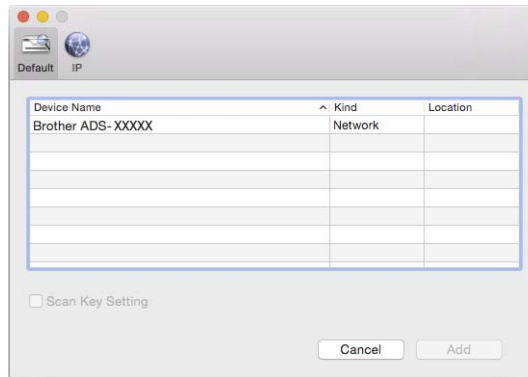

NOTE

You can also select your machine by entering the IP address. Click **IP** and enter the IP address in the **Specify your machine by IP address** field.

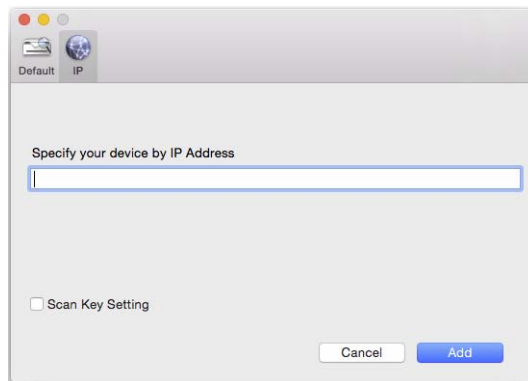

- 5 Click **Add**.

NOTE

While entering your machine's IP address, you can also configure **Scan Key Setting**. Select the **Scan Key Setting** check box to program the following options:

- To scan from the machine's Control Panel to your computer, type your computer's name in the **Display Name** field. For ADS-2800W / ADS-3600W, the name you type will appear as a destination option on the Touchscreen.
- (ADS-2800W / ADS-3600W)
To avoid receiving unwanted scanned documents, select the **Enable PIN code protection** check box, type your PIN in the **PIN code** field, and retype it in the **Verify** field.

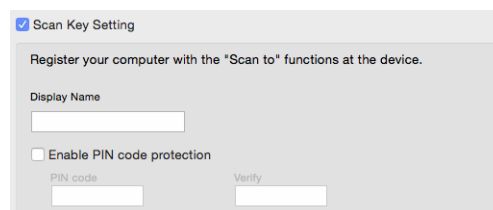

Launch the BRAdmin Utility (Windows®)

If you have installed BRAdmin Light or BRAdmin Professional 3, the **BRAdmin** button lets you open the BRAdmin Light or BRAdmin Professional 3 utility.

The BRAdmin Light utility is designed for initial setup of Brother network-connected devices. It can also search for Brother products in a TCP/IP environment, view the status, and configure basic network settings, such as the IP address. For information about installing BRAdmin Light from the supplied DVD-ROM, see the *Network User's Guide*.

If you require more advanced machine management, use the latest version of the BRAdmin Professional 3 utility that is available as a download from support.brother.com

4

- 1 Click the  (ControlCenter4) icon in the task tray and then select **Open** from the menu. The **ControlCenter4** window appears.
- 2 Click the **Device Settings** tab.
- 3 Click **BRAdmin**. The BRAdmin Light or BRAdmin Professional 3 utility dialog box appears.

NOTE

If you have installed both BRAdmin Light and BRAdmin Professional, ControlCenter4 will launch BRAdmin Professional 3.



5

Before Scanning

There are two ways to conduct scanning: using your Computer and using the machine's Control Panel. The method you use determines the available settings. For more information, see the table in *Scan Settings* on page 298.

Change the ControlCenter4 User Interface (Windows®)

ControlCenter4 is a software utility that lets you access your frequently-used applications. Using ControlCenter4 eliminates the need to manually launch specific applications.

ControlCenter4 also controls the settings for the  (PC) button (ADS-2400N / ADS-3000N), or the  PC button (ADS-2800N / ADS-3600N) on your Brother machine. For information about how to configure the settings on the machine, see *Change Scan to PC Settings (Windows®)* on page 212.

ControlCenter4 has two operation modes: **Home Mode** and **Advanced Mode**. You can change the mode at any time.

■ Home Mode

Lets you access your machine's main functions.

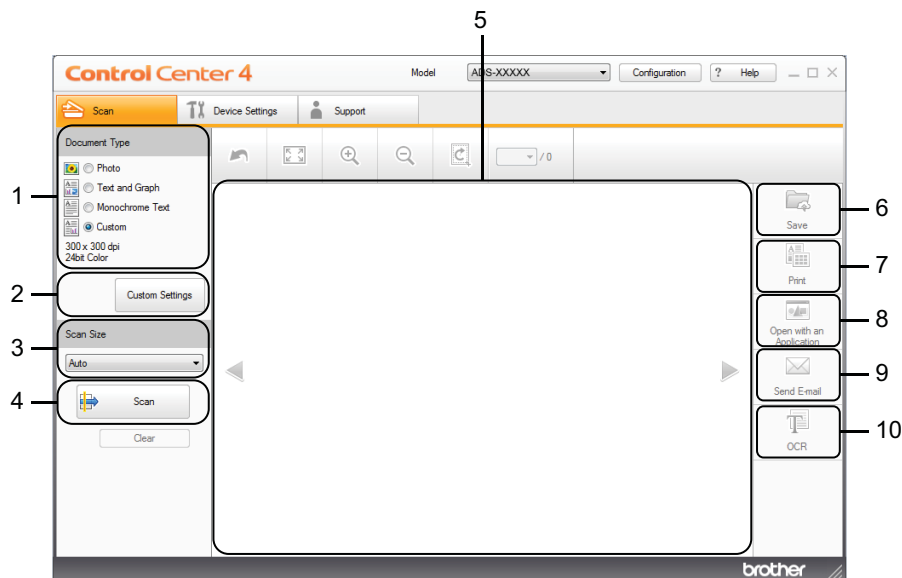

- 1 Document Type option**
Click to select a document type.
- 2 Custom Settings button**
Click to configure scan settings.
- 3 Scan Size drop-down list**
Click to select a scan size.
- 4 Scan button**
Click to start scanning.
- 5 Image viewer**
Displays a scanned image.

6 Save button

Click to save a scanned image to a folder on your hard disk or upload it to SharePoint in one of the file types shown in the file type list.

7 Print button

Click to print the scanned document on your printer.

8 Open with an Application button

Click to scan an image directly into your graphics application for image editing.

9 Send E-mail button

Click to scan a document to your default email application.

10 OCR button

Click to scan a document and convert it to text.

Advanced Mode

For you more control over the details of your machine's functions, customize one-button scan actions.

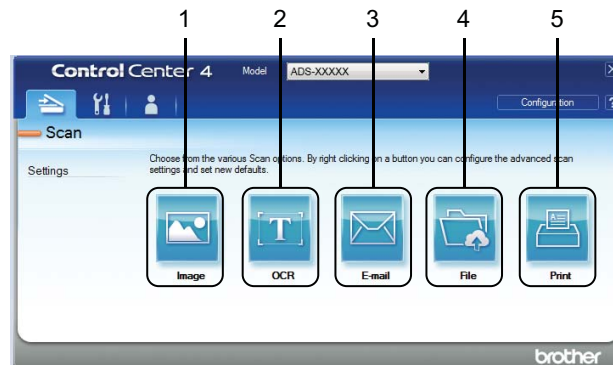

1 Image button

Click to scan a document directly into any graphic viewer/editor application.

2 OCR button

Click to scan a document and convert it to text.

3 E-mail button

Click to scan a document to your default email application.

4 File button

Click to save a scanned image to a folder on your hard disk or upload it to SharePoint in one of the file types shown in the file type list.

5 Print button



Click to print the scanned document on your printer.

To change ControlCenter4's operation mode:

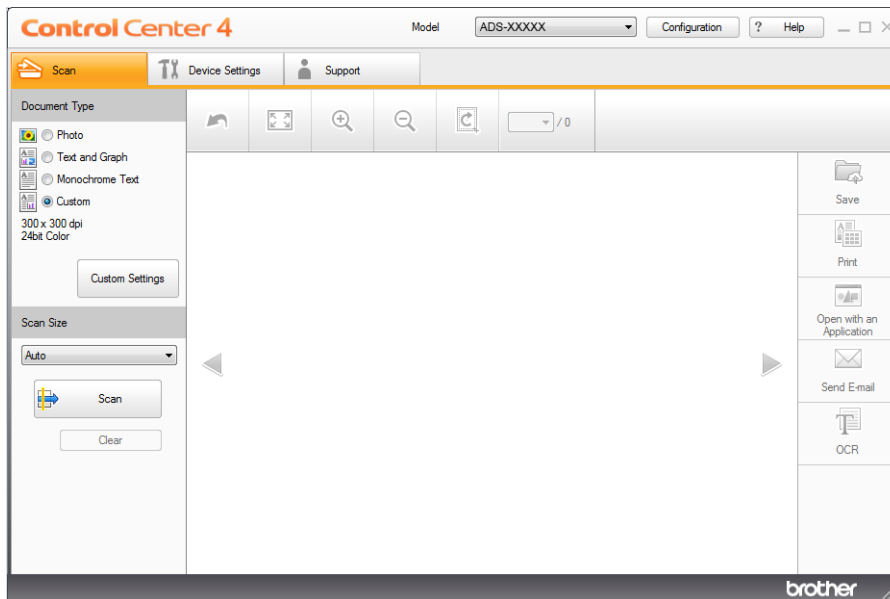
- 1 Click the  (ControlCenter4) icon in the task tray and select **Open** from the menu. The **ControlCenter4** window appears.



NOTE

If the  icon is not displayed in the task tray, click  (**Brother Utilities**) on your desktop, and then click the drop-down list and select your model name (if not already selected). Click **Scan** in the left navigation bar, and then click **ControlCenter4**.

- 2 Click **Configuration** and select **Mode Select**.
- 3 Select **Home Mode** or **Advanced Mode**, and then click **OK**.

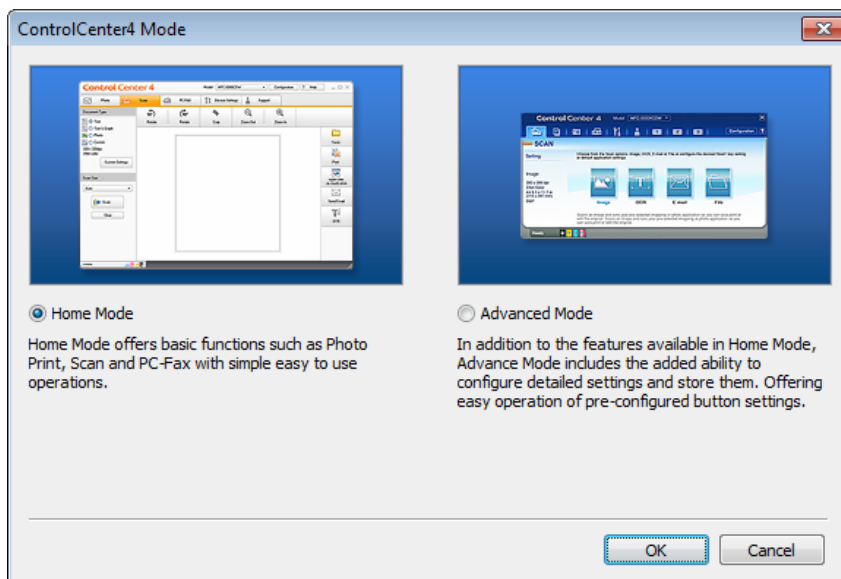





Scan Using ControlCenter4 in Home Mode (Windows®)

There are five scan options: **Save**, **Print**, **Open with an Application**, **Send E-mail**, and **OCR**.



This section briefly introduces the **Scan** tab function. For more information about each function, click  (**Help**).

Basic Scan

- 1 Select the **Document Type** and **Scan Size** for your document.
- 2 Click  (**Scan**).
- 3 Confirm and edit (if needed) the scanned image in the image viewer.
- 4 Click one of the following:
 - For  (**Save**)
Select your **Destination Folder** and other settings. Click **OK**.
The image is saved in your chosen folder.
 - For  (**Print**)
Select your printer from the drop-down list, configure the printer settings, and then click **OK**.
The scanned document starts printing.
 - For  (**Open with an Application**)
Select the application from the drop-down list, and then click **OK**.
The image appears in your chosen application.

NOTE

If you have installed the Evernote application in your computer, select Evernote from the drop-down list, and then click **OK** to upload the scanned data to Evernote directly.

- For  (**Send E-mail**)
Configure the attached file settings, and then click **OK**.
Your default email application opens and the image is attached to a new email.
- For  (**OCR**)
Configure the OCR settings, and then click **OK**.
Your chosen application opens with the converted text data.

Scan Documents Using the Carrier Sheet



- 1 Insert your document into the Carrier Sheet and place the Carrier Sheet in the ADF (see *Receipts, Clippings, Photos, and Other Documents* on page 67).

NOTE

Load only one Carrier Sheet at a time.

- 2 Click the  (ControlCenter4) icon in the task tray and select **Open** from the menu. The **ControlCenter4** window appears.

NOTE

If the  icon is not displayed in the task tray, click  (**Brother Utilities**) on your desktop, and then click the drop-down list and select your model name (if not already selected). Click **Scan** in the left navigation bar, and then click **ControlCenter4**.

- 3 Click the **Scan** tab.

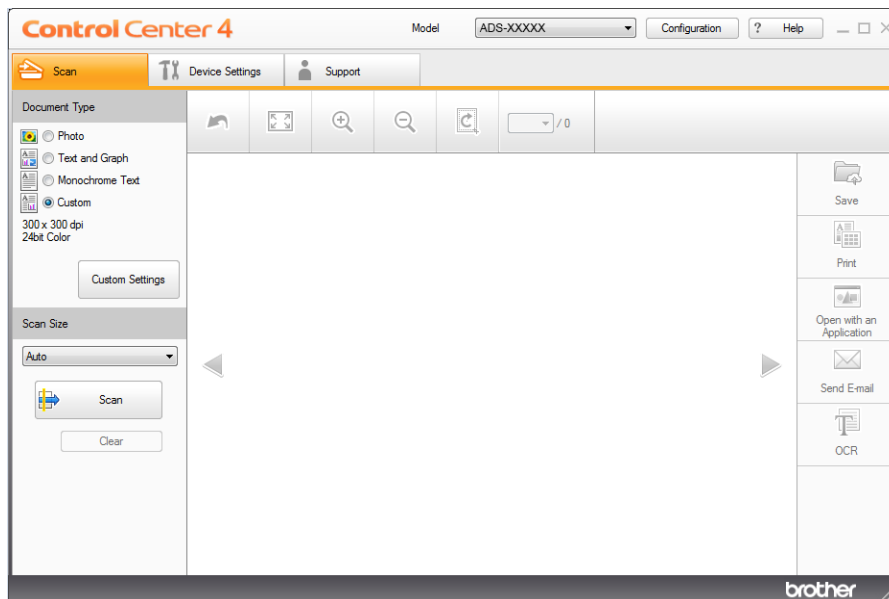



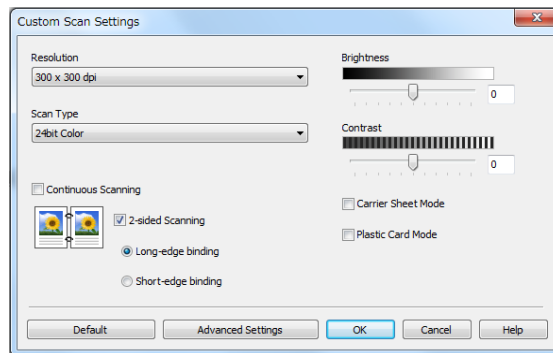

- 4 Select **Custom** in the **Document Type** drop-down list, and then click the **Custom Settings** button. The **Custom Scan Settings** dialog box appears.



- 5 Select the **Carrier Sheet Mode** check box.
- 6 Select a scan size other than **Auto** from the **Scan Size** drop-down list.
- 7 Configure other settings if needed (see *Change Scan Settings (ControlCenter4) (Windows®)* on page 100).
- 8 Click the  (**Scan**) button. The machine starts scanning, and then the **Scanning Completed** dialog box appears and displays the number of scanned pages. The scanned image appears in the image viewer.

NOTE

If the **Scanning Completed** dialog box does not appear and you want to display the number of scanned pages, select the **Display Scanning Results** check box in **Advanced Settings**.

- 9 Do one of the following:
 - Click the  (**Save**) button to save the scanned data. See *Basic Scan* on page 81.
 - Click the  (**Print**) button to print the scanned data. See *Basic Scan* on page 81.
 - Click the  (**Open with an Application**) button to open the scanned data in another application. See *Basic Scan* on page 81.
 - Click the  (**Send E-mail**) button to attach the scanned data to an email. See *Basic Scan* on page 81.
 - Click the  (**OCR**) button to scan to an editable text file. See *Basic Scan* on page 81.

Scan Plastic Cards

- 1 Load a plastic card (see *Business Cards* on page 62).

NOTE

Load up to five plastic cards at a time.

- 2 Click the  (ControlCenter4) icon in the task tray and select **Open** from the menu. The **ControlCenter4** window appears.
- 3 Click the **Scan** tab.

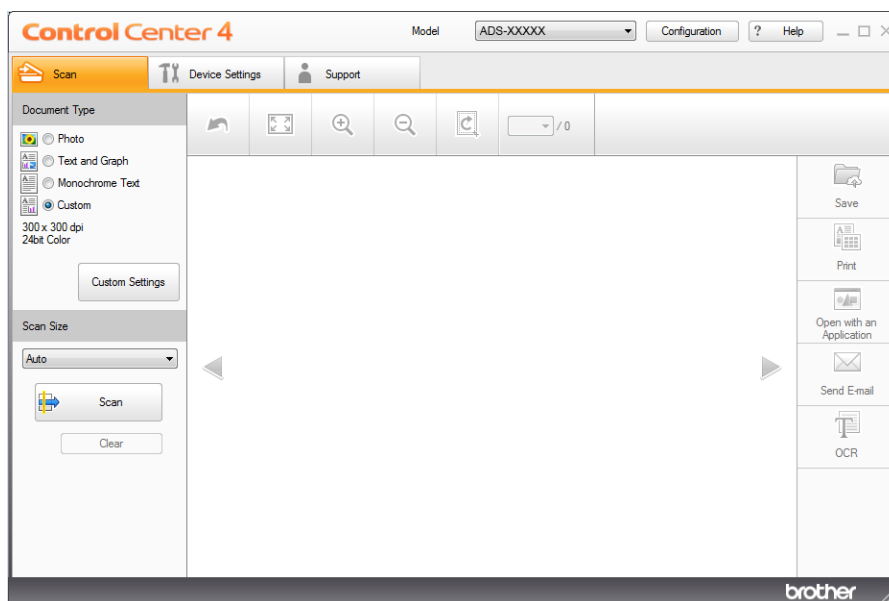

- 4 Select **Custom** in the **Document Type** drop-down list, and then click the **Custom Settings** button. The **Custom Scan Settings** dialog box appears.

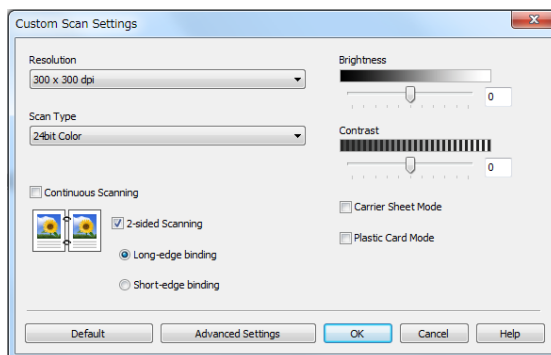





- 5 Select the **Plastic Card Mode** check box.
- 6 Configure other settings if needed (see *Change Scan Settings (ControlCenter4) (Windows®)* on page 100).

- 7 Click the  (**Scan**) button. The machine starts scanning, and then the **Scanning Completed** dialog box appears. The scanned image appears in the image viewer.

NOTE

If the **Scanning Completed** dialog box does not appear and you want to display the number of scanned pages, select the **Display Scanning Results** check box in **Advanced Settings**.

- 8 Do one of the following:
 - Click the  (**Save**) button to save the scanned data. See *Basic Scan* on page 81.
 - Click the  (**Print**) button to to print the scanned data. See *Basic Scan* on page 81.
 - Click the  (**Open with an Application**) button to open the scanned data in another application. See *Basic Scan* on page 81.
 - Click the  (**Send E-mail**) button to attach the scanned data to an email. See *Basic Scan* on page 81.
 - Click the  (**OCR**) button to scan to an editable text file. See *Basic Scan* on page 81.

NOTE

Plastic Card Mode automatically uses these settings:

- **Resolution:** 600 x 600 dpi
- **Document Size:** 2 in 1 (Auto)
- **2-sided Scanning:** On (**Short-edge binding**)
- **Auto Deskew:** On
- **Multifeed Detection:** Off
- **Auto Image Rotation:** Off

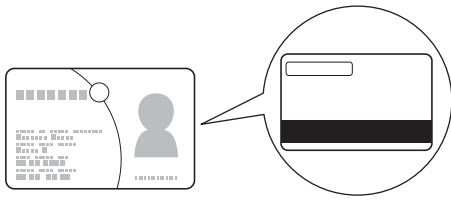
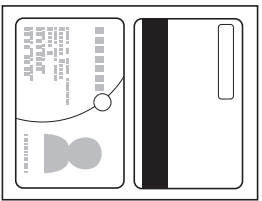
Original Layout	Scan Result
	

Scan Documents to SharePoint

Scan documents and save them to a SharePoint server. Your Brother machine must be connected to a wireless (ADS-2800W / ADS-3600W) or wired network.

- 1 Load your document (see *Standard-size Documents* on page 60).
- 2 Click the  (ControlCenter4) icon in the task tray and select **Open** from the menu. The **ControlCenter4** window appears.
- 3 Click the **Scan** tab.

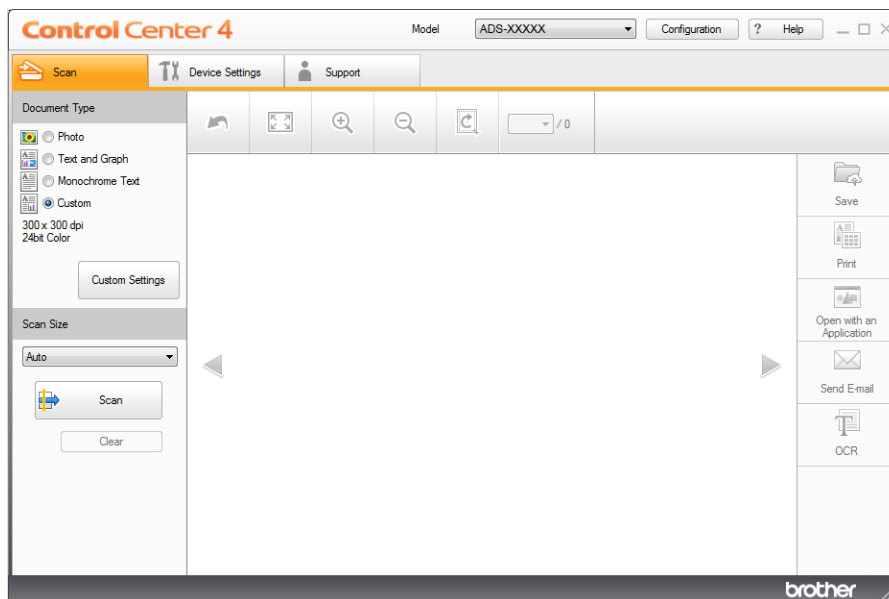

- 4 Select the document type.
- 5 Change the size of your document, if needed.
- 6 Configure other settings if needed (see *Change Scan Settings (ControlCenter4) (Windows®)* on page 100).
- 7 Click the  (**Scan**) button. The machine starts scanning, and then the **Scanning Completed** dialog box appears and displays the number of scanned pages. The scanned image appears in the image viewer.

NOTE

If the **Scanning Completed** dialog box does not appear and you want to display the number of scanned pages, select the **Display Scanning Results** check box in **Advanced Settings**.

- 8 Click  (**Save**). The **Save** dialog box appears.
- 9 Click the **File Type** drop-down list, and then select the file type.

NOTE

To save the document as a password-protected PDF, select **Secure PDF (*.pdf)** from the **File Type** drop-down list, click , and then type the password.

- 10 In the **File Name** field, type a prefix for your file name, if needed.
- 11 In the **Scan Location** field, select the **SharePoint** radio button, and then type the server address where you want to save your scanned documents.
- 12 Click the **Connection Test** button to confirm the server connection.
The message **Connected** appears.

NOTE

If the security dialog box appears, type your user name and password.





- 13 Click **OK**. If a message dialog box about the Internet connection appears, read the information and click **OK**.
The scanned document is saved in the destination server.

Scan Using ControlCenter4 in Advanced Mode (Windows®)

There are five scan options available in Advanced Mode: **Image**, **OCR**, **E-mail**, **File** and **Print**.

This section briefly introduces the **Scan** tab function. For more information about each function, click  (**Help**).

Basic Scan

- 1 Click the **Scan** tab.
- 2 Click one of the following:
 - For  (**Image**)
Select the application from the drop-down list and click **Scan**.
The image appears in your chosen application.
 - For  (**OCR**)
Configure the OCR settings and click **Scan**.
Your chosen application opens with the converted text data.
 - For  (**E-mail**)
Configure the attached file settings and click **Scan**.
Your default email application opens and the image is attached to a new email.
 - For  (**File**)
Select your **Scan Location** and other settings. Click **Scan**.
The image is saved in your chosen folder.
 - For  (**Print**)
Select your printer from the drop-down list, configure the printer settings, and then click **Scan**.
The scanned document starts printing.

NOTE

(For **Image** and **OCR**)

If you have installed the Evernote application in your computer, select Evernote from the drop-down list, and then click **OK** to upload the scanned data to Evernote directly.

Scan to Image

The Scan to Image feature lets you scan an image directly into your graphics application for image editing.

- 1 Click the **Scan** tab.
- 2 Click  (**Image**).
The **Image** dialog box appears.

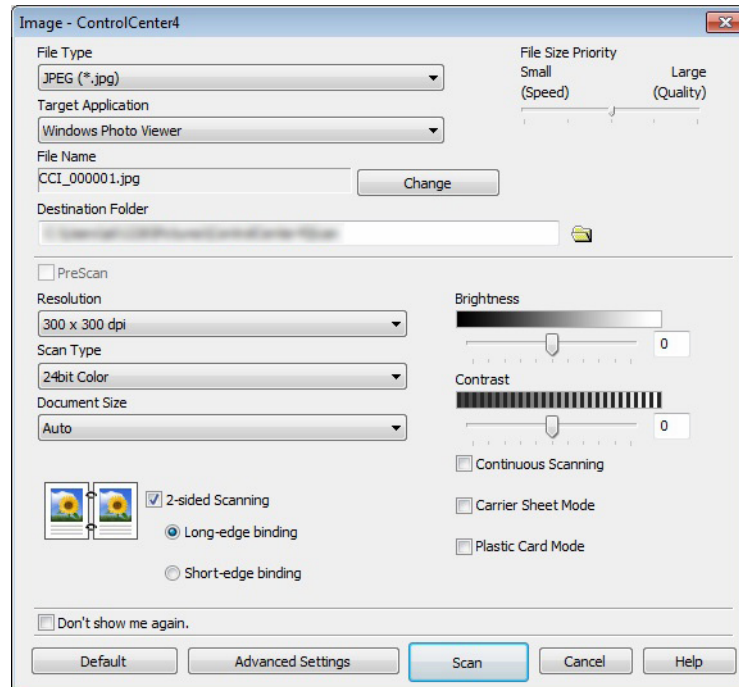

- 3 Configure the scan settings, if needed.
 - To scan a 2-sided document, select the **2-sided Scanning** check box and choose **Long-edge binding** or **Short-edge binding**.
 - To change the application that you want to use, choose the appropriate application from the **Target Application** pop-up menu.
- 4 Click **Scan**.
Your default application will start and display the image.

NOTE

If you choose **Secure PDF (*.pdf)** from the **File Type** list, the **Set PDF Password** dialog box appears. Enter your password in the **Password** and **Re-type Password** boxes, and then click **OK**. You can also choose **Secure PDF (*.pdf)** for Scan to E-mail and Scan to File.

Scan to OCR

The Scan to OCR feature lets you convert the graphic page image data into text that can be edited by any word processing application. You can change the default word processing application.

- 1 Click the **Scan** tab.
- 2 Click  (**OCR**).
The **OCR** dialog box appears.

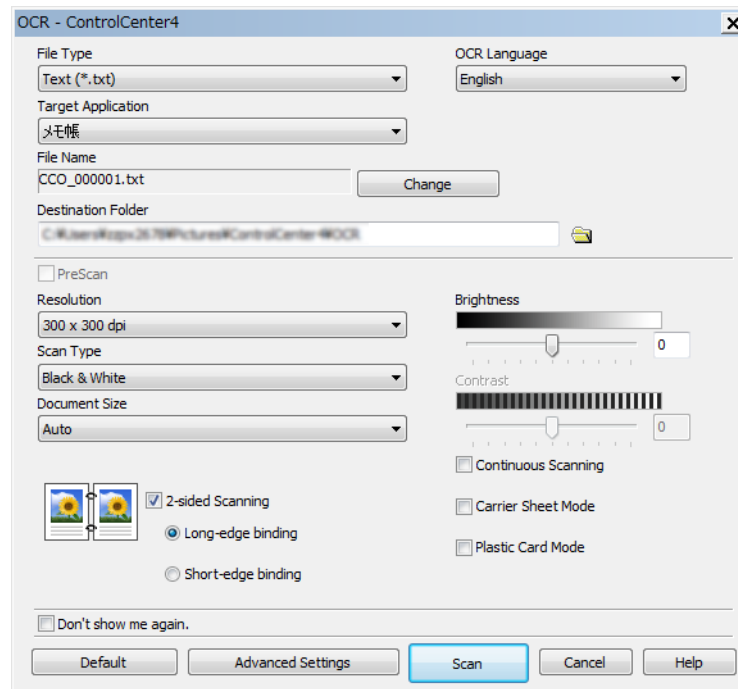

- 3 Configure the scan settings, if needed.
 - To scan a 2-sided document, select the **2-sided Scanning** check box and choose **Long-edge binding** or **Short-edge binding**.
 - To change the word processing application that you want to use, choose the appropriate application from the **Target Application** pop-up menu.
- 4 Click **Scan**.
Your default word processing application will start and display the converted text data.

Scan to E-mail

The Scan to E-mail feature lets you scan a document to your default email application so you can send the scanned document as an attachment.

- 1 Click the **Scan** tab.
- 2 Click  (**E-mail**).
The **E-mail** dialog box appears.

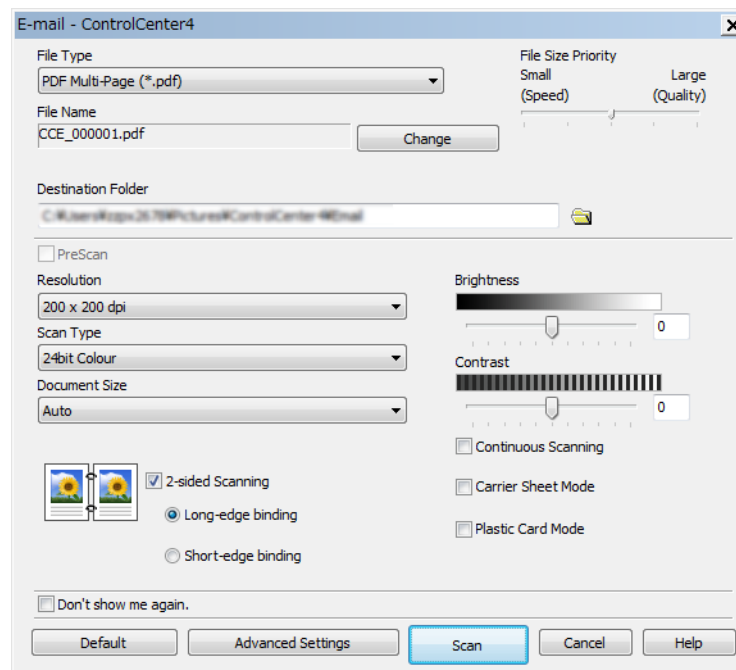

- 3 Configure the scan settings, if needed.
 - To scan a 2-sided document, select the **2-sided Scanning** check box and choose **Long-edge binding** or **Short-edge binding**.
- 4 Click **Scan**.
Your default email application will start and the image will be attached to a new email.

NOTE

The Scan to E-mail feature does not support Webmail services. Use the Scan to Image or Scan to File feature to scan a document or picture, and then attach the file of the scanned data to message.

Scan to File

The Scan to File feature lets you scan an image to a folder on your hard disk in a supported file format. This feature allows you to easily archive your paper documents.

- 1 Click the **Scan** tab.
- 2 Click  (**File**).
The **File** dialog box appears.

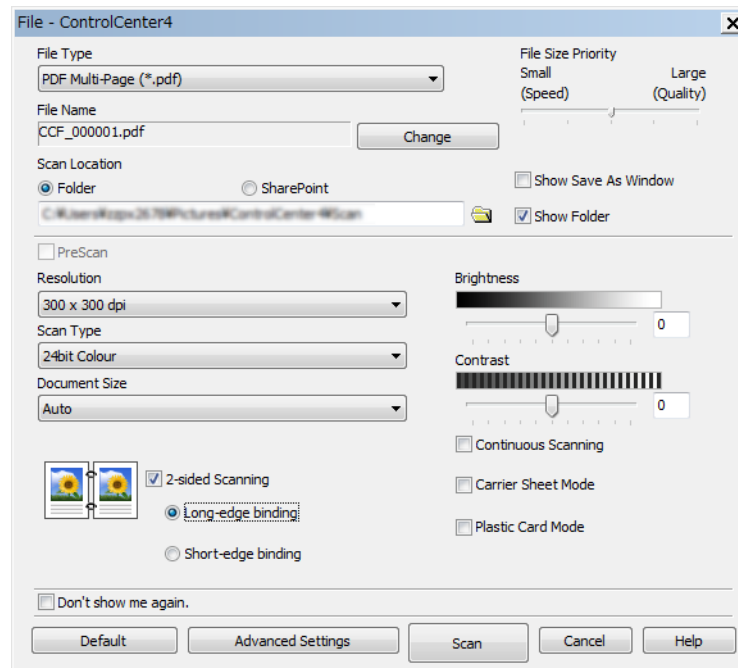

- 3 Configure the scan settings, if needed.
 - To scan a 2-sided document, select the **2-sided Scanning** check box and choose **Long-edge binding** or **Short-edge binding**.
 - To change the file name, enter the file name you want to use for the document (up to 100 characters) in the **File Name** box. The file name will be the file name you entered plus the current date and a sequential number.
 - Choose the file type for the saved image from the **File Type** pop-up menu. You can save the file to the default folder, or choose your preferred folder by clicking  (**Browse**).
 - To show where the scanned image is saved when scanning is finished, select the **Show Folder** check box. If you want to specify the destination of the scanned image every time, select the **Show Save As Window** check box.
- 4 Click **Scan**.
The image will be saved in the folder you have chosen.

Change a Scan Button's Default Settings

- 1 Right-click the button that you want to configure and click **Button settings**. The settings dialog box appears.
- 2 Configure the settings as needed.
- 3 Click **OK**. The new settings will be used as the default settings.

Scan Using the Carrier Sheet

- 1 Load your document into the Carrier Sheet and load the Carrier Sheet into your machine (see *Receipts, Clippings, Photos, and Other Documents* on page 67).

NOTE

Load only one Carrier Sheet at a time.

- 2 Click the  (ControlCenter4) icon in the task tray and select **Open** from the menu. The **ControlCenter4** window appears.
- 3 Select the **Scan** tab.



- Click the button you want to use ( (**Image**),  (**OCR**),  (**E-mail**),  (**File**) or  (**Print**)). The settings dialog box appears (the example below uses **Image**).

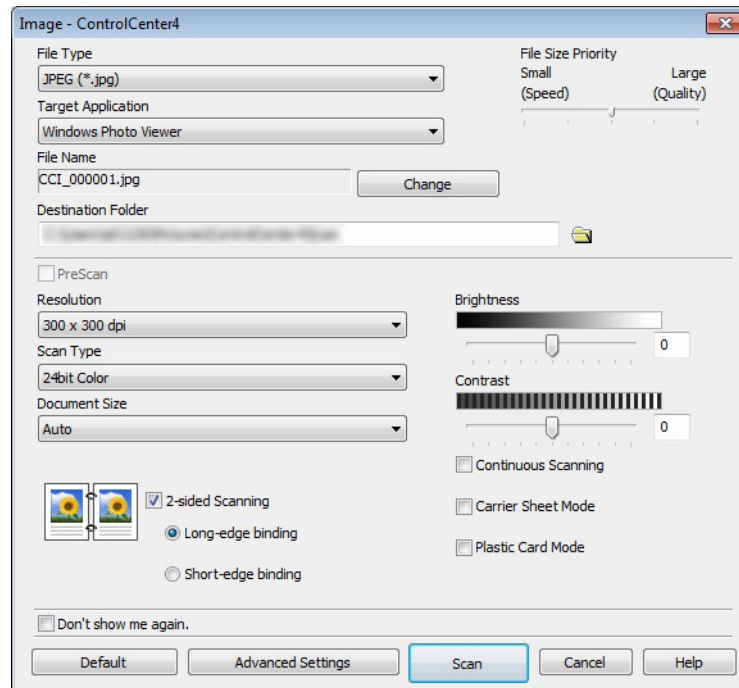

- Check the **Carrier Sheet Mode** check box.
- Select a document size other than **Auto** from the **Document Size** drop-down list.
- Change other settings if needed (see *Change Scan Settings (ControlCenter4) (Windows®)* on page 100).
- Click the **Scan** button.
The machine starts scanning.

NOTE

If you do not want to see the settings dialog box again, select the **Don't show me again.** check box.

Scan Plastic Cards

- Load a plastic card (see *Business Cards* on page 62).





NOTE

Load up to five plastic cards at a time.

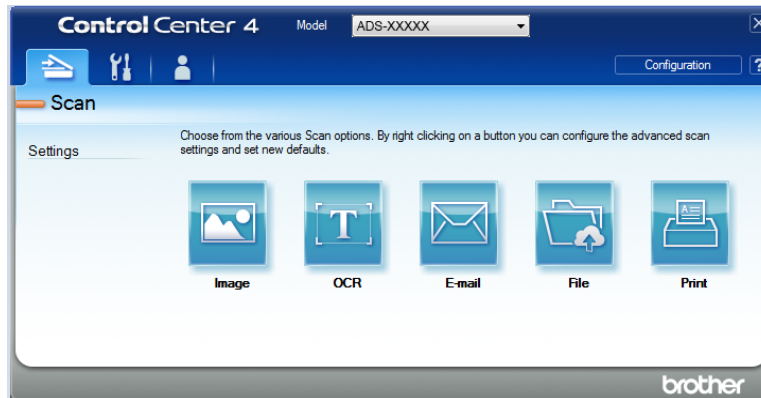
- Click the  (ControlCenter4) icon in the task tray and select **Open** from the menu.
The **ControlCenter4** window appears.

- 3 Click the **Scan** tab.



- 4 Click the button you want to use ( (**Image**),  (**OCR**),  (**E-mail**),  (**File**), or  (**Print**)). The settings dialog box appears (the example below uses **Image**).

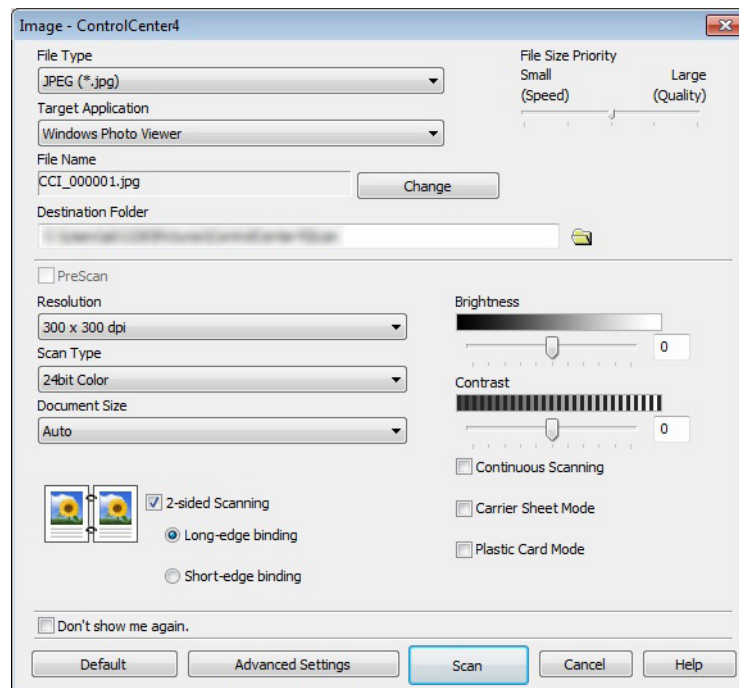

- 5 Select the **Plastic Card Mode** check box.
- 6 Change other settings if needed (see *Change Scan Settings (ControlCenter4) (Windows®)* on page 100).
- 7 Click the **Scan** button. The machine starts scanning.

NOTE

- If you do not want to see the settings dialog box again, select the **Don't show me again.** check box.
- **Plastic Card Mode** automatically uses these settings:
 - **Resolution: 600 x 600 dpi**
 - **Document Size: 2 in 1 (Auto)**
 - **2-sided Scanning: On (Short-edge binding)**
 - **Auto Deskew: On**
 - **Auto Image Rotation: Off**
 - **Multifeed Detection: Off**

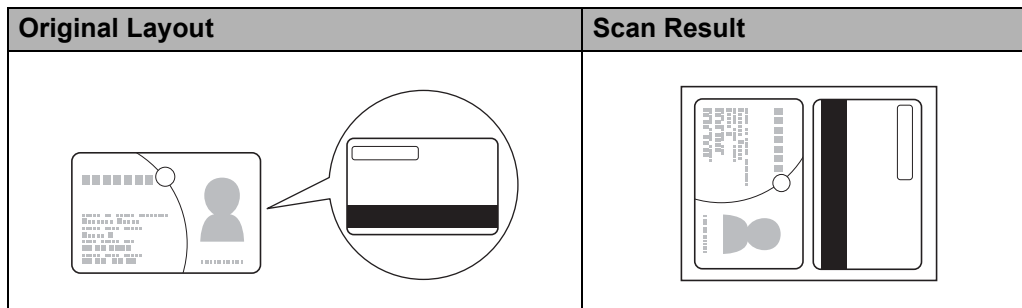

Scan Documents to SharePoint

Scan documents and save them to a SharePoint server. Your Brother machine must be connected to a wireless (ADS-2800W / ADS-3600W) or wired network.

- 1 Load your document (see *Standard-size Documents* on page 60).
- 2 Click the  (ControlCenter4) icon in the task tray and select **Open** from the menu. The **ControlCenter4** window appears.
- 3 Click the **Scan** tab.



- 4 Click  (**File**). The settings dialog box appears.

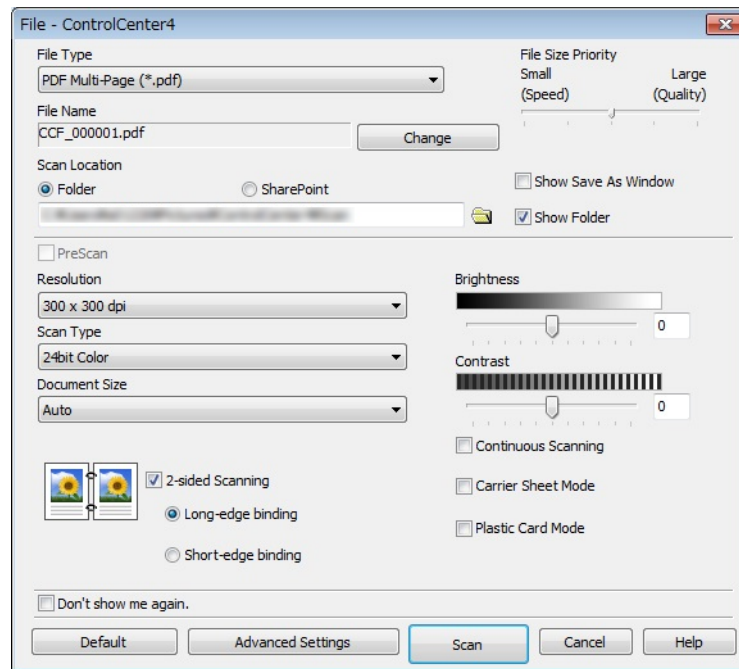

- 5 In the **Scan Location** field, select the **SharePoint** radio button, and then enter the server address where you would like to save your scanned documents.
- 6 Change other settings if needed (see *Change Scan Settings (ControlCenter4) (Windows®)* on page 100).
- 7 Click the **Connection Test** button to confirm the server connection. The message **Connected** appears.

NOTE

If the security dialog box appears, type your user name and password.

- 8 Click **Scan**. If a message dialog box about the Internet connection appears, read the information and click **OK**. The scanned document is saved in the destination server.

Create a Custom Tab (ControlCenter4 Advanced Mode) (Windows®)

Create up to three customized tabs that include up to five customized buttons with your preferred settings.

Create a Custom Tab

- 1 Click the  (ControlCenter4) icon in the task tray and select **Open** from the menu. The **ControlCenter4** window appears.

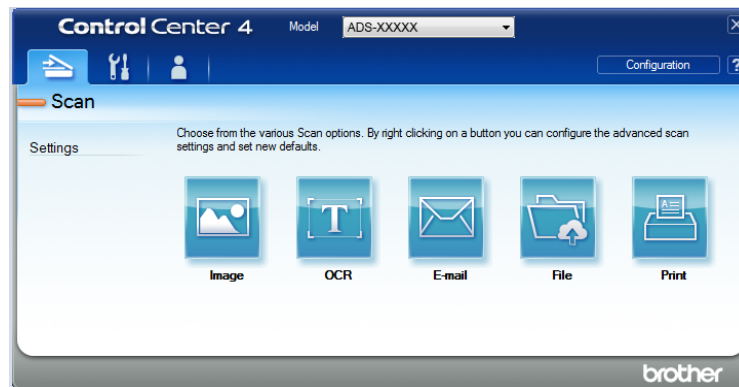

- 2 Click **Configuration** and then select **Create custom tab**. You can also create a custom tab by right-clicking the tab area and selecting **Create custom tab**. A custom tab will be created.

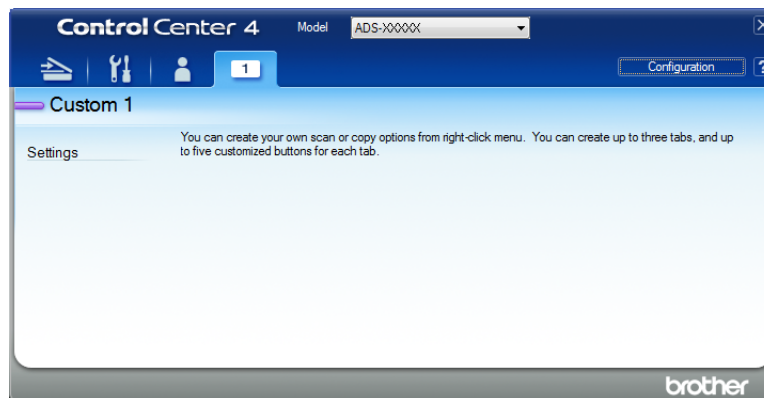

- 3 To change the name of a custom tab, right-click the custom tab and select **Rename custom tab**. Enter the new name. The name appears in the upper left corner of the custom tab.

NOTE

- You can also change the name of the custom tab by clicking **Configuration** and then clicking **Rename custom tab**.
 - You can make up to 3 custom tabs.
-

Create a Custom Button in a Custom Tab

- 1 Create a Custom tab. See *Create a Custom Tab* on page 98.
- 2 Right-click the new Custom tab, and select **Create custom button**. Select the button you want to create from the menu. The settings dialog box appears.

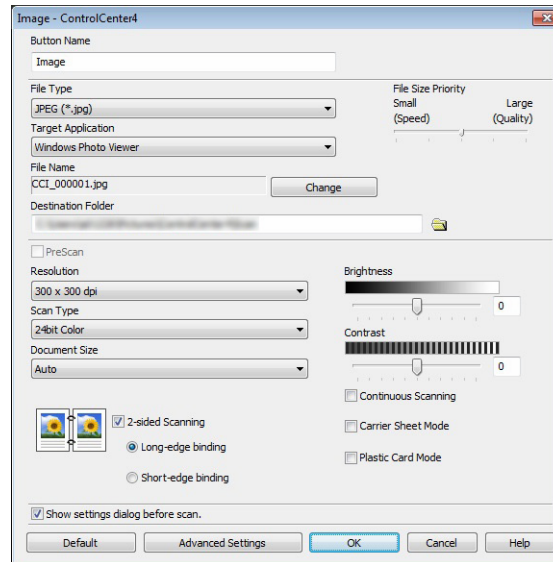

NOTE

- To copy a custom button, select **Copy custom button** from the menu that appears when you right-click the Custom tab. Rename the custom button.
- You can make up to 5 custom buttons.

- 3 Type the button name and change the settings if needed. Click **OK**.
(The setting options may vary depending on the type of button you create.)

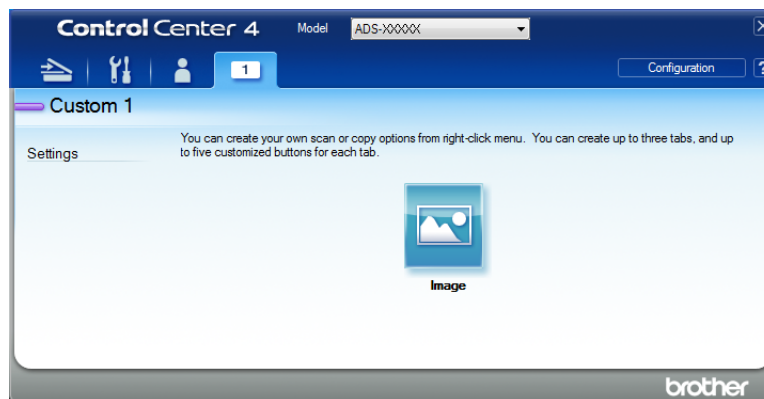

NOTE

You can change or remove the tab, button, or settings you created. Click **Configuration** and continue as prompted.

Change Scan Settings (ControlCenter4) (Windows®)

The following settings can be changed.

Setting	Description	Applicable Feature				
		Image	OCR	E-mail	File	Print
File Type	Select the file type you want to use for the scanned data. NOTE <ul style="list-style-type: none"> To save the document as a password-protected PDF, select Secure PDF (*.pdf) from the File Type drop-down list, click the  (Set PDF Password) button, and enter the password (Image, E-mail and File only). Searchable PDF is a file format that includes the text data layer over a scanned image. This layer allows you to search the text on the image data. OCR Language in the OCR setting must be set to match the language you want for the searchable PDF. To save the document as a searchable PDF, select Searchable PDF (*.pdf) from the File Type drop-down list. To save the document as a searchable PDF, Nuance™ PaperPort™ 14SE must be installed on your computer. To save the document as a high compression PDF, select 300 x 300 dpi from the Resolution drop-down list, High Compression PDF (*.pdf) from the File Type drop-down list and True Gray or 24bit Color from the Scan Type drop-down list. 	Yes	Yes	Yes	Yes	-
Target Application	Select the destination application including Nuance™ PaperPort™ 14SE and Evernote from the drop-down list.	Yes	Yes	-	-	-
OCR Language	Set to match the language of the scanned document's text.	-	Yes	-	-	-
Printer Name	Select the printer you want to use to print the scanned data.	-	-	-	-	Yes
File Name	Click the Change button for Image , OCR or E-mail . Enter a prefix for the file name if needed. The maximum number of characters is 100 characters.	Yes	Yes	Yes	Yes	-
Print Options	Click the Print Options button to configure the printer settings.	-	-	-	-	Yes

Setting	Description	Applicable Feature				
		Image	OCR	E-mail	File	Print
Show Save As Window	To specify the destination of the scanned image every time you scan, select the Show Save As Window check box. NOTE This feature is not available with SharePoint.	-	-	-	Yes	-
Destination Folder	Click the Folder icon to change the folder where you want to save your scanned image.	Yes	Yes	Yes	-	-
File Name	To define file naming attributes, click the Change button.					
Scan Location	Select one of the Scan Locations: <ul style="list-style-type: none"> • Folder Click the folder icon and browse to the folder where you want to save your scanned document. Select the Show Folder check box to automatically display the destination folder after scanning. To specify the destination of the scanned image every time, select the Show Save As window check box. • SharePoint Write the URL address where you would like to save your scanned document. Click Connection Test to confirm the destination. NOTE You may have to log on.	-	-	-	Yes	-
File size Priority	Adjust the file size by moving the slider to the right or left. NOTE File size can be adjusted depending on your selected File Type .	Yes	-	Yes	Yes	-
PreScan	Select PreScan to preview your image and crop unwanted portions before scanning.	Yes	Yes	Yes	Yes	Yes
Resolution	Select a scanning resolution from the Resolution drop-down list. Higher resolutions take more memory and transfer time, but produce a finer scanned image.	Yes	Yes	Yes	Yes	Yes

Setting	Description	Applicable Feature				
		Image	OCR	E-mail	File	Print
Scan Type	<p>Select from several color depth options for scanned images.</p> <p>Auto Automatically selects suitable colors for your document. ¹</p> <p>Black & White Use for text or line art images.</p> <p>Gray (Error Diffusion) Use for photographic images or graphics. (Error Diffusion is a method for creating simulated grayscale images without using true gray dots. Black dots are put in a specific pattern to give a gray appearance.)</p> <p>True Gray Use for photographic images or graphics. This mode is more exact due to using up to 256 shades of gray.</p> <p>24bit Color Uses up to 16.8 million colors to scan the image. Although using 24bit Color creates an image with the most accurate color reproduction, it requires the most memory and has the longest transfer time.</p>	Yes	Yes	Yes	Yes	Yes

¹ Depending upon the condition of the original document, this function may not work properly.

Setting	Description	Applicable Feature				
		Image	OCR	E-mail	File	Print
Document Size	<p>Document size is set to Auto by default. You can scan documents of any size without making adjustments to Document Size.¹ For faster scan speeds, select the exact size of your document from the Document Size drop-down list.</p> <p>NOTE</p> <ul style="list-style-type: none"> • If you select a 1 to 2 document size, the scanned image will be divided into two documents that are half the size of the setting. If you select 1 to 2(A4), the scanned image will be divided into two A5-size documents. • To do 1 to 2 scanning, clear the Auto Image Rotation check box in the Advanced Settings dialog box. • If you select a 2 in 1 document size, two scanned images will be combined into one document. 	Yes	Yes	Yes	Yes	Yes
Brightness	<p>Adjust the setting (-50 to 50) to get the best image. The default value of 0 represents an average and is suitable for most images. Set the Brightness level by dragging the slider to the right or left to lighten or darken the image. You can also enter a value in the box to set the level. If the scanned image is too light, set a lower Brightness level and scan the document again. If the image is too dark, set a higher Brightness level and scan the document again.</p>	Yes	Yes	Yes	Yes	Yes

¹ Depending upon the condition of the original document, this function may not work properly.

Setting	Description	Applicable Feature				
		Image	OCR	E-mail	File	Print
Contrast	Adjust the setting (-50 to 50) to get the best image. The default value of 0 represents an average and is suitable for most images. Increase or decrease the contrast level by moving the slider to the right or left. An increase emphasizes dark and light areas of the image, while a decrease reveals more details in gray areas. You can also enter a value in the box to set the Contrast . NOTE The Contrast setting is only available when setting Scan Type to Auto, Gray (Error Diffusion), True Gray or 24bit Color .	Yes	Yes	Yes	Yes	Yes
Continuous Scanning	Scan more pages than the maximum capacity of the ADF and save them as one data file. After the first batch of documents is scanned click Continue for additional pages or Finish .	Yes	Yes	Yes	Yes	Yes
2-sided Scanning	If you select this box, the machine scans both sides of the document. When using the automatic 2-sided (duplex) scan feature, you must select Long-edge binding or Short-edge binding depending on the layout of your original to make sure that the data file created appears correctly in the scanned document.	Yes	Yes	Yes	Yes	Yes
Carrier Sheet Mode	Scan the following document types using the Carrier Sheet. For this mode, select any setting other than Auto from the Document Size drop-down list. <ul style="list-style-type: none"> ■ Large-sized Documents (A3, B4 and Ledger) Fold the document in half and insert it in the Carrier Sheet for 2-sided (duplex) scanning, then both front and back pages will be combined into a single page. Select 2 in 1(A4) for an A3 document, 2 in 1(B5) for a B4 document or 2 in 1(Letter) for a Ledger document from the Document Size drop-down list. ■ Important documents (photos, contracts) ■ Thin paper (receipts) ■ Irregular-shaped paper (clippings) NOTE <ul style="list-style-type: none"> • Load only one Carrier Sheet at a time. • Load the document in the center of the Carrier Sheet and align the top of the document with the top of the Carrier Sheet. 	Yes	Yes	Yes	Yes	Yes

Setting	Description	Applicable Feature				
		Image	OCR	E-mail	File	Print
Plastic Card Mode	<p>Scan cards, such as driver's licenses or insurance cards, using these automatic settings:</p> <ul style="list-style-type: none"> ■ Resolution: 600 x 600 dpi ■ Document Size: 2 in 1 (Auto) ■ 2-sided Scanning: On (Short-edge binding) ■ Auto Deskew: On ■ Auto Image Rotation: Off ■ Multifeed Detection: Off <p>NOTE</p> <ul style="list-style-type: none"> • To scan a plastic card with different settings, set Plastic Card Mode to off and Resolution to 600 dpi. • Load up to five plastic cards at a time. 	Yes	Yes	Yes	Yes	Yes
Default	Restore all settings to their factory default values.	Yes	Yes	Yes	Yes	Yes

You can configure more settings in the **Advanced Settings** dialog box. Click the **Advanced Settings** button.

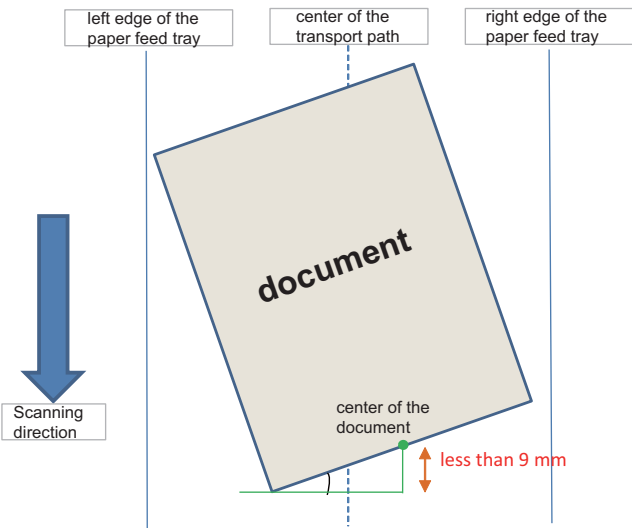
Setting	Description	Applicable Feature				
		Image	OCR	E-mail	File	Print
Auto Deskew	<p>Corrects the skew (less than 0.36 in. (9 mm) from the center of the document to the edge) of the scanned data.¹</p> 	Yes	Yes	Yes	Yes	Yes
Auto Image Rotation	Changes the direction of the document based on the text orientation. ¹	Yes	Yes	Yes	Yes	Yes
Remove Bleed-through / Pattern / Remove Background Color	<p>Prevents bleed through on a two-sided document, and also allows you to remove the base color of documents, such as newspapers, to make the scanned data more recognizable.¹</p> <p>The sensitivity of the Remove Bleed-through / Pattern / Remove Background Color function can be adjusted with the slider. Moving the slider toward “High” will make the scanner more likely to Remove Bleed-through / Pattern / Remove Background Color, while moving it toward “Low” will make the scanner less likely to Remove Bleed-through / Pattern / Remove Background Color.</p>	Yes	Yes	Yes	Yes	Yes
Skip Blank Page	Removes blank pages of the document from the scanning results. ¹	Yes	Yes	Yes	Yes	Yes
Multifeed Detection	Uses a ultrasonic sensor to detect when a multifeed has occurred. When this function detects a multifeed, confirm that the data scanned before the multifeed has been saved, and then start scanning again at the next page or the beginning of the document.	Yes	Yes	Yes	Yes	Yes
Display Scanning Results	Shows the numbers of total pages saved and blank pages skipped on your computer screen.	Yes	Yes	Yes	Yes	Yes

¹ Depending upon the condition of the original document, this function may not work properly.

Scan Using ControlCenter2 (Macintosh)

ControlCenter2 is a software utility that lets you access your frequently-used applications. Using ControlCenter2 eliminates the need to manually launch specific applications.

There are four scan options: **Scan to Image**, **Scan to OCR**, **Scan to E-mail** and **Scan to File**.

- **Image** (Default: *Apple Preview*)

Lets you scan a page directly into any graphic viewer/editor application. Choose the destination application, such as Adobe® Photoshop® or any kind of image editing application on your computer.

- **OCR** (Default: *Apple TextEdit*)

Lets you scan a page or document, automatically run the OCR application and put text (not a graphic image) into a word processing application. Choose the target word processing application, such as Microsoft® Word or any word processing application on your computer.

- **E-mail** (Default: *your default email software*)

Lets you scan a page or document directly into an email application as a standard attachment. Choose the file type and resolution for the attachment.



- **File**

Lets you scan directly to a disk file. You can change the file type and destination folder, as needed.

ControlCenter2 gives you the ability to configure the hardware to PC button on your machine and the ControlCenter2 software button for each scan feature. To configure the hardware to PC button on your machine choose the **Device Button** tab in the configuration menu for each of the **SCAN** buttons. To configure the software button in ControlCenter2 choose the **Software Button** tab in the configuration menu for each of the **SCAN** buttons.

To start ControlCenter2, click the  (ControlCenter2) icon in the Dock.



If the  (ControlCenter2) icon is not displayed in the Dock, in the **Finder** menu bar, click **Go > Applications > Brother**, and then double-click the  (ControlCenter2) icon.

The  ControlCenter2 will start.

Scan to Image

The **Scan to Image** feature lets you scan an image directly into your graphics application for image editing. This example uses the Apple Preview application.

1 Click the **SCAN** tab.

2 Click  (**Image**).

The **Scan to Image** dialog box appears.

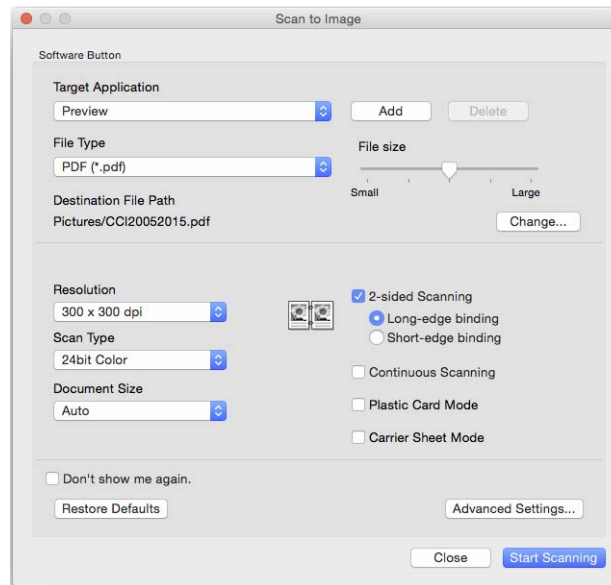

3 Configure the scan settings, if needed.

- To scan a 2-sided document, select the **2-sided Scanning** check box and choose **Long-edge binding** or **Short-edge binding**.
- To change the application that you want to use, choose the appropriate application from the **Target Application** pop-up menu. Add an application to the list by clicking **Add**. To delete an application, click **Delete**.

4 Click **Start Scanning**.
Your default application will start and display the image.

NOTE

If you choose **Secure PDF (*.pdf)** from the **File Type** list, the **Set PDF Password** dialog box appears. Enter your password in the **Password** and **Re-type Password** boxes, and then click **OK**. You can also choose **Secure PDF (*.pdf)** for **Scan to E-mail** and **Scan to File**.

Scan to OCR

The **Scan to OCR** feature lets you convert the graphic page image data into text that can be edited by any word processing application. You can change the default word processing application.

1 Click the **SCAN** tab.

2 Click  (**OCR**).

The **Scan to OCR** dialog box appears.

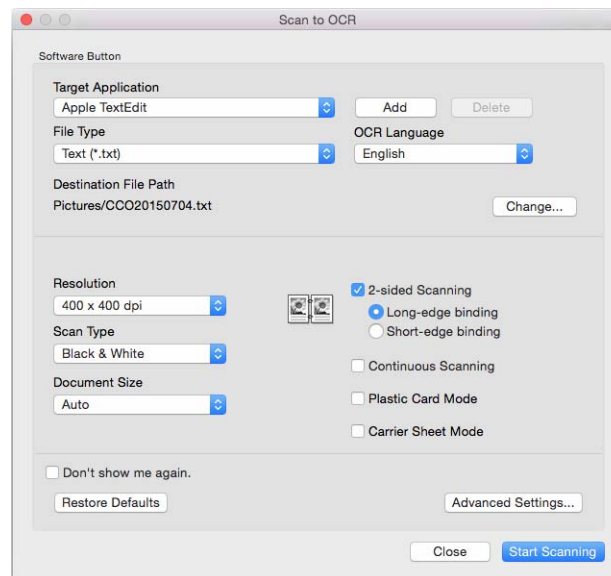

3 Configure the scan settings, if needed.

- To scan a 2-sided document, select the **2-sided Scanning** check box and choose **Long-edge binding** or **Short-edge binding**.
- To change the word processing application that you want to use, choose the appropriate application from the **Target Application** pop-up menu. Add an application to the list by clicking **Add**. To delete an application, click **Delete**.

4 Click **Start Scanning**.

Your default word processing application will start and display the converted text data.

Scan to E-mail

The **Scan to E-mail** feature lets you scan a document to your default email application so you can send the scanned document as an attachment.

1 Click the **SCAN** tab.

2 Click  (**E-mail**).

The **Scan to E-mail** dialog box appears.

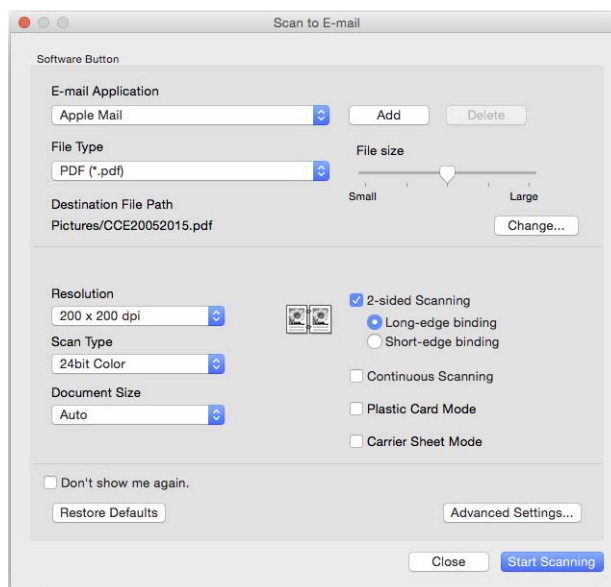

3 Configure the scan settings, if needed.

- To scan a 2-sided document, select the **2-sided Scanning** check box and choose **Long-edge binding** or **Short-edge binding**.
- To change the email application that you want to use, choose the appropriate application from the **E-mail Application** pop-up menu. Add an application to the list by clicking **Add**¹. To delete an application, click **Delete**.

¹ When you first start ControlCenter2, a default list of compatible email applications appears in the pop-up menu. If you are having trouble using a custom application with ControlCenter2, you should choose an application from the list.

4 Click **Start Scanning**.

Your default email application will start and the image will be attached to a new email.

NOTE

The Scan to E-mail feature does not support Webmail services. Use the Scan to Image or Scan to File feature to scan a document or picture, and then attach the file of the scanned data to message.

Scan to File

The **Scan to File** feature lets you scan an image to a folder on your hard disk in a supported file format. This feature allows you to easily archive your paper documents.

1 Click the **SCAN** tab.

2 Click  (**File**).

The **Scan to File** dialog box appears.

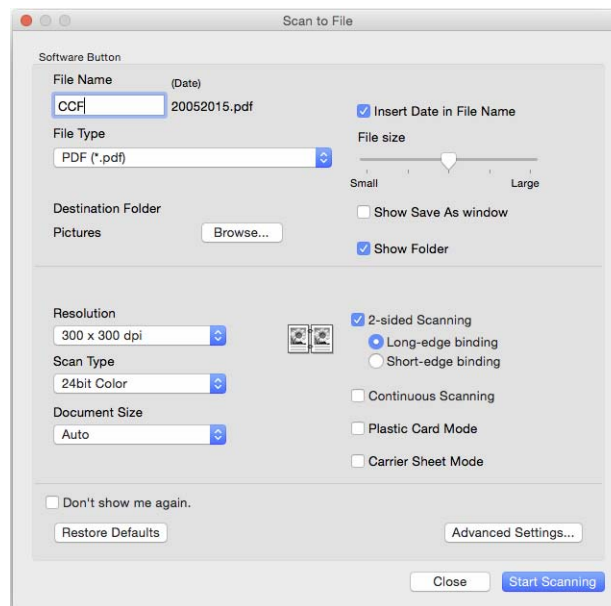

3 Configure the scan settings, if needed.

- To scan a 2-sided document, select the **2-sided Scanning** check box and choose **Long-edge binding** or **Short-edge binding**.
- To change the file name, enter the file name you want to use for the document (up to 100 characters) in the **File Name** box. The file name will be the file name you entered plus the current date and a sequential number.
- Choose the file type for the saved image from the **File Type** pop-up menu. You can save the file to the default folder, or choose your preferred folder by clicking **Browse**.
- To show where the scanned image is saved when scanning is finished, select the **Show Folder** check box. To specify the destination of the scanned image every time, select the **Show Save As window** check box.

4 Click **Start Scanning**.
The image will be saved in the folder you have chosen.

Change a Scan Button's Default Settings

- 1 Hold down the **Control** key on your keyboard, and then click the ControlCenter2 scan button that you want to change. When the menu appears, click **Software Button** or **Device Button**. The settings dialog box appears.
- 2 Choose the settings for **File Type**, **Scan Type**, **Document Size**, **Brightness**, **Contrast**, **2-sided Scanning** and **Continuous Scanning** as needed.
- 3 Click **OK**. The new settings will be used as the default settings.

Scan Specific and Irregular Sized Documents Using the Carrier Sheet

- 1 Load the Carrier Sheet (see *Receipts, Clippings, Photos, and Other Documents* on page 67).



NOTE

Load only one Carrier Sheet at a time.

- 2 Click the  (ControlCenter2) icon in the Dock. The **ControlCenter2** window appears.



NOTE

If the  (ControlCenter2) icon is not displayed in the Dock, in the **Finder** menu bar, click **Go > Applications > Brother**, and then double-click the  (ControlCenter2) icon. The  (ControlCenter2) icon appears in the Dock.

- 3 Click the **SCAN** tab, and then click the button for the Scan-to action you want to change (**Image**, **OCR**, **E-mail**, or **File**). The settings dialog box appears (the example below uses **Image**).

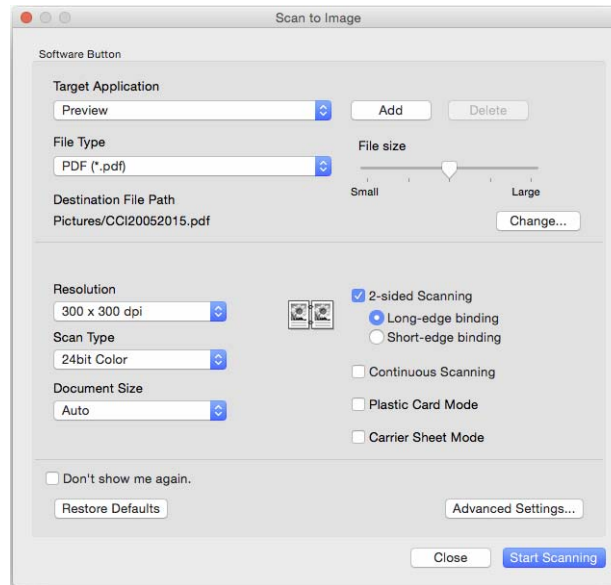

- 4 Select the **Carrier Sheet Mode** check box.
- 5 Select a document size other than **Auto** from the **Document Size** pop-up menu.
- 6 Change other settings if needed (see *Change Scan Settings (ControlCenter2) (Macintosh)* on page 120).
- 7 Click **Start Scanning**.
Your default application will start and display the image.

Scan Plastic Cards

- 1 Load a plastic card (see *Business Cards* on page 62).

NOTE

Load up to five plastic cards at a time.

- 2 Click the  (ControlCenter2) icon in the Dock. The **ControlCenter2** window appears.



- 3 Click the **SCAN** tab, and then click the button for the Scan-to action you want to change (**Image**, **OCR**, **E-mail**, or **File**). The settings dialog box appears (the example below uses **Image**).

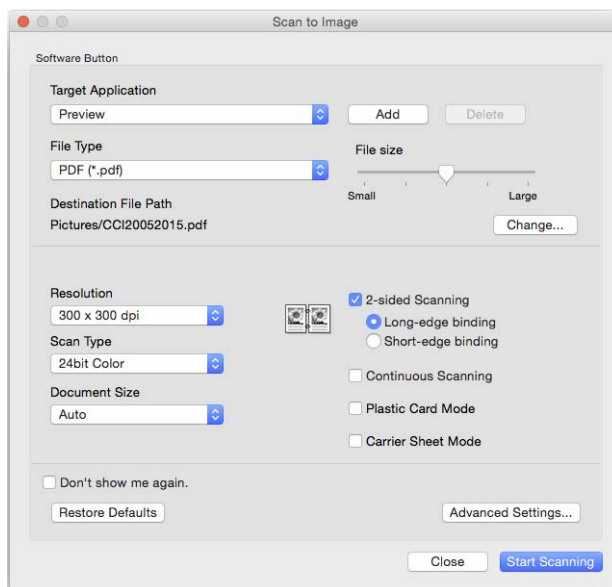

- 4 Click the **Plastic Card Mode** check box.
- 5 Change other settings if needed (see *Change Scan Settings (ControlCenter2) (Macintosh)* on page 120).
- 6 Click **Start Scanning**. Your default application will start and display the image.

NOTE

- If you do not want to see the settings dialog box again, select the **Don't show me again.** check box.
- **Plastic Card Mode** automatically uses these settings:
 - **Resolution: 600 x 600 dpi**
 - **Document Size: 2 in 1 (Auto)**
 - **2-sided Scanning: On (Short-edge binding)**
 - **Auto Deskew: On**
 - **Auto Image Rotation: Off**
 - **Multifeed Detection: Off**

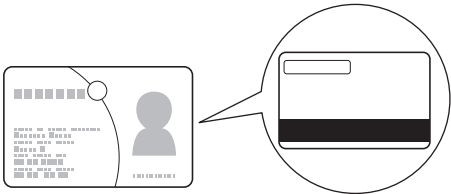
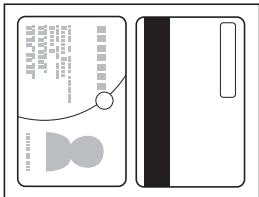
Original Layout	Scan Result
 The image shows a plastic card with a barcode at the top, a photo of a person, and some text. A circular callout with a pointer highlights the top edge of the card, showing a close-up of the scanning area.	 The scan result shows the card split into two parts. The left part is the original orientation, and the right part is rotated 90 degrees counter-clockwise, demonstrating the 'Short-edge binding' scanning mode.

Register Your Favorite Scan Settings Using ControlCenter2 (Macintosh)

There are four buttons that you can configure to fit your scanning needs.

To customize a button, click the button while holding down the **Control** key, and the configuration window appears. There are four scan functions: **Scan to Image**, **Scan to OCR**, **Scan to E-mail** and **Scan to File**.

■ Scan to Image

Lets you scan a page directly into any image viewer/editor software. Choose any image editor application on your computer as a destination.

■ Scan to OCR

Converts scanned documents into editable text files. Choose the destination application for the editable text.

■ Scan to E-mail

Attaches the scanned images to an email message. You can also choose the file attachment type and create a quick send list of email addresses chosen from your email address book.

■ Scan to File

Lets you save a scanned image to any folder on a local or network hard disk. You can also choose the file type to be used.

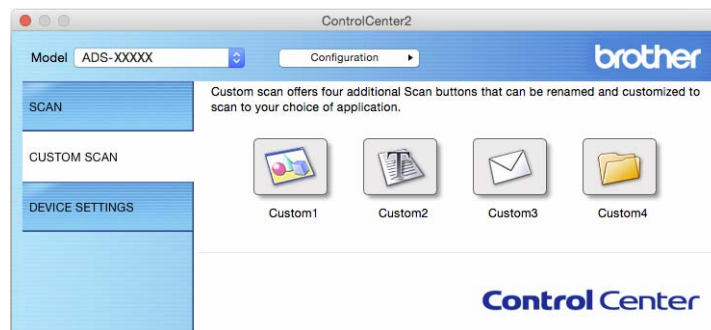

User-defined Button

To customize a button, click the button while holding down the **Control** key, and the configuration window appears. Follow these guidelines for button configuration.

Scan to Image/OCR/E-mail/File

■ General tab

Enter a name in **Name for Custom** (up to 30 characters) to create the button name.

Choose the type of scan from the **Scan Action** selections.

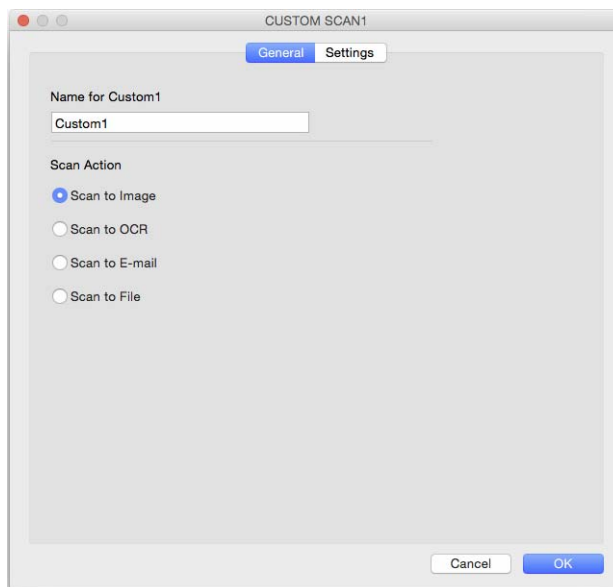

■ **Settings** tab (Scan to Image/OCR/ E-mail)

Choose the **Target Application**, **File Type**, **Resolution**, **Scan Type**, **Document Size** and **2-sided Scanning** settings.

NOTE

The Scan to E-mail feature does not support Webmail services. Use the Scan to Image or Scan to File feature to scan a document or picture, and then attach the file of the scanned data to an email message.

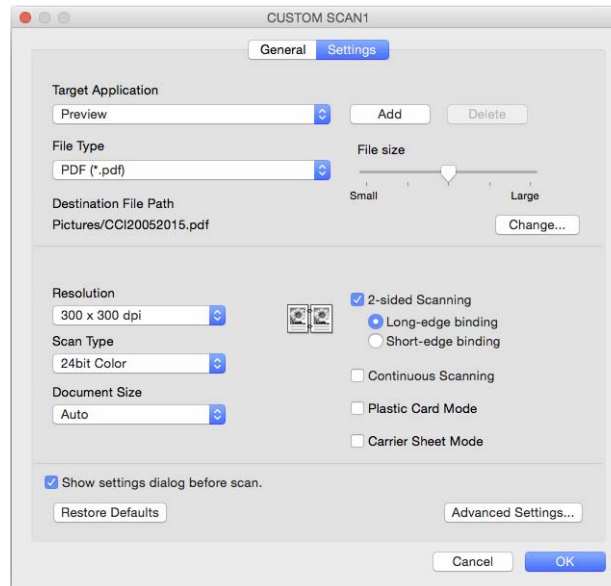

If you choose **Secure PDF (*.pdf)** from the **File Type** list, the **Set PDF Password** dialog box appears. Enter your password in the **Password** and **Re-type Password** box and then click **OK**.

NOTE

Secure PDF (*.pdf) is available for Scan to Image, Scan to E-mail and Scan to File.

■ **Settings** tab (Scan to File)

Choose the file format from the **File Type** pop-up menu. Save the file to the default folder or choose your preferred folder by clicking the **Browse** button.

Choose the **Resolution**, **Scan Type**, **Document Size** and **2-sided Scanning** settings.

To specify the destination of the scanned image, select the **Show Save As window** check box.

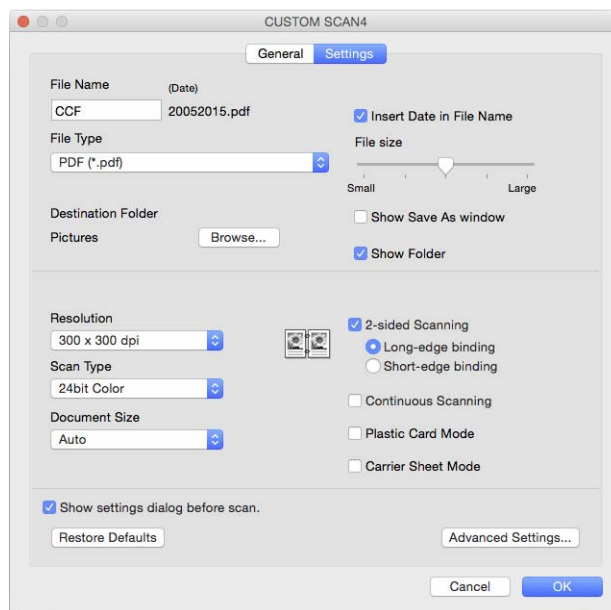

Change Scan Settings (ControlCenter2) (Macintosh)

The following settings can be changed.

Setting	Description	Applicable Feature			
		Image	OCR	E-mail	File
Target Application (for Image and OCR) or E-mail Application (for email)	Select which application is used to open scanned data. Only applications installed on your computer (including ABBYY FineReader Pro and Evernote) can be selected. <ul style="list-style-type: none"> ■ Add button Add an application to the pop-up menu. Enter the Application Name (up to 30 characters) and select your preferred application by clicking the Browse button. Also select the File Type from the pop-up menu. ■ Delete button Delete an application that you have added. Select the Application Name and click the Delete button. 	Yes	Yes	Yes	-
File Type	Select the file type you want to use for the scanned data. <p>NOTE</p> <ul style="list-style-type: none"> • To save the document as a password-protected PDF, select Secure PDF (*.pdf) for File Type and then enter the password in the Set PDF Password dialog box (Image, E-mail and File only). • Searchable PDF is a file format that includes the text data layer over a scanned image. This layer allows you to search the text on the image data. OCR Language in the OCR setting must be set to match the language you want to make the searchable PDF for. • To save the document as a searchable PDF, select Searchable PDF (*.pdf) from the File Type drop-down list. • To save the document as a high compression PDF, select 300 x 300 dpi from the Resolution pop-up menu, High Compression PDF (*.pdf) from the File Type pop-up menu and True Gray or 24bit Color from the Scan Type pop-up menu. • Several file types such as TIFF, TIFF Multi-Page, PDF, Secure PDF and JPEG support file size compression. Select Uncompressed or Compressed to adjust the file size for TIFF or TIFF Multi-Page. For PDF, Secure PDF and JPEG, use the slider to adjust the file size (not available for Scan to OCR). 	Yes	Yes	Yes	Yes

Setting	Description	Applicable Feature			
		Image	OCR	E-mail	File
File Size	Adjust the File Size by moving the slider to the right or left. NOTE File Size can be adjusted depending on your selected File Type .	Yes	-	Yes	Yes
OCR Language	Set to match the language of the scanned document's text.	-	Yes	-	-
File Name	Enter a prefix for the file name if needed.	Yes	Yes	Yes	Yes
Show Save As window	To specify the destination of the scanned image every time you scan, select the Show Save As window check box.	-	-	-	Yes
Destination File Path	Click the Change button to change the folder where you want to save your scanned image.	Yes	Yes	Yes	-
File Name	Click the Change button for Image , OCR or E-mail . Enter a prefix for the file name if needed. Click Insert Date in File Name if needed.				
Destination Folder	Click the Browse button and navigate to the folder where you want to save your scanned document. Check Show Folder to automatically display the destination folder after scanning.	-	-	-	Yes
Resolution	Select a scanning resolution from the Resolution pop-up menu. Higher resolutions take more memory and transfer time, but produce a finer scanned image.	Yes	Yes	Yes	Yes
Scan Type	Select from a range of scan color depth. Black & White Use for text or line art images. Gray (Error Diffusion) Use for photographic images or graphics. (Error Diffusion is a method for creating simulated grayscale images without using true gray dots. Black dots are put in a specific pattern to give a gray appearance.) True Gray Use for photographic images or graphics. This mode is more exact due to using up to 256 shades of gray. 24bit Color Uses up to 16.8 million colors to scan the image. Although using 24bit Color creates an image with the most accurate color reproduction, it requires the most memory and has the longest transfer time. Auto Uses suitable colors for your document automatically. ¹	Yes	Yes	Yes	Yes

¹ Depending upon the condition of the original document, this function may not work properly.

Setting	Description	Applicable Feature			
		Image	OCR	E-mail	File
Document Size	<p>Document size is set to Auto by default. You can scan documents of any size without making adjustments to Document Size.¹ For faster scan speeds, select the exact size of your document from the Document Size pop-up menu.</p> <p>NOTE</p> <ul style="list-style-type: none"> If you select a 1 to 2 document size, the scanned image will be divided into two documents that are half the size of the setting. If you select 1 to 2(A4), the scanned image will be divided into two A5-size documents. To do 1 to 2 scanning or 2 in 1 scanning, clear the Auto Image Rotation check box in the Advanced Settings dialog box. If you select a 2 in 1 document size, two scanned images will be combined into one document. You can select Long Paper when you configure the settings as the following: <ul style="list-style-type: none"> Auto Deskew: Off 2-sided Scanning: Off Each Long Paper option can scan a large document up to following: <p>Long Paper (Normal Width) 8 1/2 in. (215.9 mm): 8 1/2 × 34.0 in. (215.9 × 863.0 mm)</p> <p>Long Paper (Narrow Width) 4 1/4 in. (107.9 mm): 4 1/4 × 34.0 in. (107.9 × 863.0 mm)</p> 	Yes	Yes	Yes	Yes
2-sided Scanning	<p>If you check this box, the machine scans both sides of the document. When using the automatic 2-sided (duplex) scan feature, you must select Long-edge binding or Short-edge binding, depending on the layout of your original, to make sure that the data file created appears correctly in the scanned document.</p> <p>NOTE</p> <p>The 2-sided (duplex) scanning feature is available with lengths up to Legal size.</p>	Yes	Yes	Yes	Yes
Restore Defaults	Restore all settings to their factory default values.	Yes	Yes	Yes	Yes
Continuous Scanning	Scan more pages than the maximum capacity of the ADF and save them as one data file. After the first batch of documents is scanned click Continue for additional pages or Finish .	Yes	Yes	Yes	Yes

¹ Depending upon the condition of the original document, this function may not work properly.

Setting	Description	Applicable Feature			
		Image	OCR	E-mail	File
Carrier Sheet Mode	<p>You can scan the following documents using the Carrier Sheet. For this mode, select any setting other than Auto from the Document Size pop-up menu.</p> <ul style="list-style-type: none"> ■ Large-sized Documents (A3, B4 and Ledger) Fold the document in half and insert it in the Carrier Sheet for 2-sided (duplex) scanning, then both front and back pages will be combined into a single page. Select 2 in 1(A4) for an A3 document, 2 in 1(B5) for a B4 document or 2 in 1(Letter) for a Ledger document from the Document Size pop-up menu. ■ Important documents (photos, contracts) ■ Thin paper (receipts) ■ Irregularly-shaped paper (clippings) <p>NOTE</p> <ul style="list-style-type: none"> • Load only one Carrier Sheet at a time. • Insert the document in the center of the Carrier Sheet and align the top of the document with the top of the Carrier Sheet. 	Yes	Yes	Yes	Yes
Plastic Card Mode	<p>Scan cards, such as driver's licenses or insurance cards, using these automatic settings:</p> <ul style="list-style-type: none"> ■ Resolution: 600 x 600 dpi ■ Document Size: 2 in 1 (Auto) ■ 2-sided Scanning: On (Short-edge binding) ■ Auto Deskew: On ■ Auto Image Rotation: Off ■ Multifeed Detection: Off <p>NOTE</p> <ul style="list-style-type: none"> • To scan a plastic card with different settings, set Plastic Card Mode to Off and Resolution to 600 dpi. • Load up to five plastic cards at a time. 	Yes	Yes	Yes	Yes

You can configure more settings in the **Advanced Settings** dialog box. Click the **Advanced Settings** button.

Setting	Description	Applicable Feature			
		Image	OCR	E-mail	File
Brightness	Adjust the setting (0 to 100) to get the best image. The default value of 50 represents an average and is suitable for most images. Set the Brightness level by dragging the slider to the right or left to lighten or darken the image. If the scanned image is too light, set a lower Brightness level and scan the document again. If the image is too dark, set a higher Brightness level and scan the document again.	Yes	Yes	Yes	Yes
Contrast	Adjust the setting (0 to 100) to get the best image. The default value of 50 represents an average and is suitable for most images. Increase or decrease the contrast level by moving the slider to the right or left. An increase emphasizes dark and light areas of the image, while a decrease reveals more details in gray areas. NOTE The Contrast setting is only available when setting Scan Type to Auto, Gray (Error Diffusion), True Gray or 24bit Color .	Yes	Yes	Yes	Yes
Color Drop	Deletes specific colors from your scanned data. Select one of the following: <ul style="list-style-type: none"> ■ Chromatic colors Use to remove all colors except Black. ■ Red Use to remove the Red color. ■ Green Use to remove the Green color. ■ Blue Use to remove the Blue color. ■ Custom Select the color that you want to remove. 	Yes	Yes	Yes	Yes

Setting	Description	Applicable Feature			
		Image	OCR	E-mail	File
Auto Deskew	Corrects the skew (less than 0.36 in. (9 mm) from the center of the document to the edge) of the scanned data. ¹	Yes	Yes	Yes	Yes
Auto Image Rotation	Changes the direction of the document based on the text orientation. ¹	Yes	Yes	Yes	Yes
Bleed Through Prevention/ Remove Background Color	Prevents bleed through on a two-sided document, and if you enable the Remove Background Color setting, this machine remove the base color of documents, such as newspapers, to make the scanned data more recognizable. ¹	Yes	Yes	Yes	Yes
Skip Blank Page	Removes blank pages of the document from the scanning results. ¹	Yes	Yes	Yes	Yes
Multifeed Detection	Uses a ultrasonic sensor to detect when a multifeed has occurred. When this function detects a multifeed, confirm that the data scanned before the multifeed has been saved, and then start scanning again at the next page or the beginning of the document.	Yes	Yes	Yes	Yes
Display Scanning Results	Shows the numbers of total pages saved and blank pages skipped on your computer screen.	Yes	Yes	Yes	Yes

¹ Depending upon the condition of the original document, this function may not work properly.

Scan Using Nuance™ PaperPort™ 14SE or Other Windows® Applications

Scan Using Nuance™ PaperPort™ 14SE

You can use the Nuance™ PaperPort™ 14SE application, which is included in the Brother MFL-Pro software suite, for scanning. Nuance™ PaperPort™ 14SE supports both TWAIN and WIA drivers; the TWAIN driver (recommended) is used in the example on this page. For an example using the WIA driver, see *Scan Using Windows® Photo Gallery or Windows® Fax and Scan* on page 142.

NOTE

- Nuance™ PaperPort™ 14SE supports Windows® XP (SP3 or later), Windows Vista® (SP2 or later), Windows® 7, Windows® 8 and Windows® 8.1.
 - The WIA driver with Windows® XP (SP2 or later) does not support 2-sided (duplex) scanning.
 - For more information about the application see the Nuance™ PaperPort™ 14SE Help file. Access this from the Nuance™ PaperPort™ 14SE **Help** menu.
-

These instructions are for Nuance™ PaperPort™ 14SE, but are similar for other Windows® applications.

- 1 Load your document.

2 Start Nuance™ PaperPort™ 14SE. Do one of the following:

- Windows® XP, Windows Vista® and Windows® 7

Click  (**Start**) > **All Programs** > **Nuance PaperPort 14** > **PaperPort**.

- Windows® 8 and Windows® 8.1

Click  (**PaperPort**).

The Nuance™ PaperPort™ 14SE window appears.

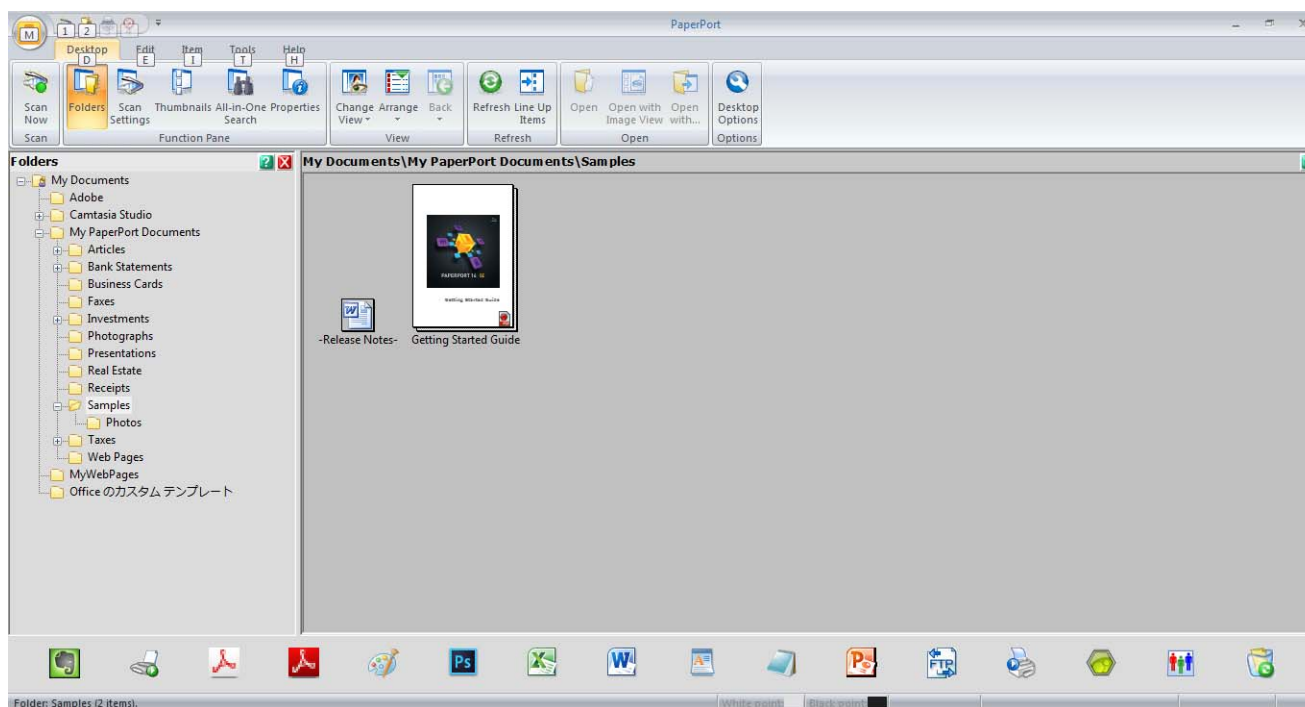

- 3 Click **Scan Settings** from the **Desktop** tab on the ribbon. The **Scan or Get Photo** panel appears on the left side of the window.

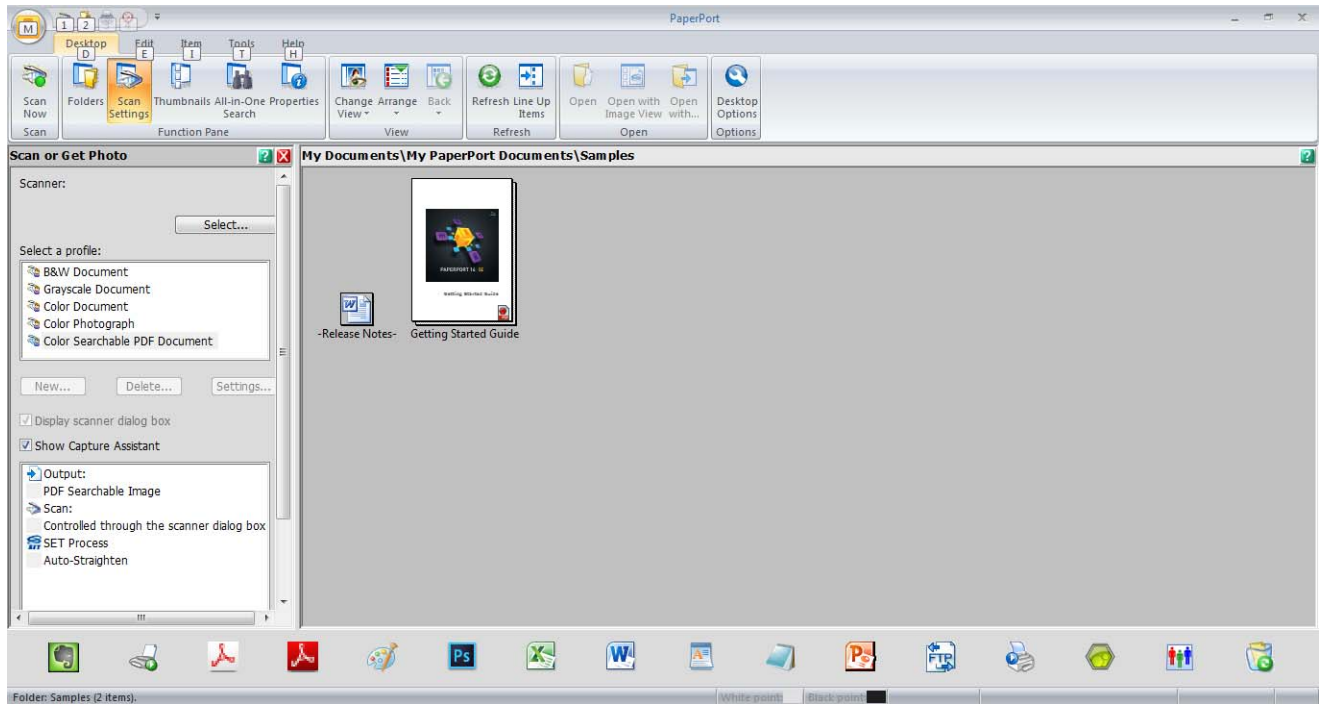

- 4 Click the **Select** button.
- 5 From the **Available Scanners** list, select **TWAIN: TW-Brother ADS-XXXXX** (where ADS-XXXXX is the model name of your machine). To use the WIA driver, select the Brother driver that has "WIA" as the prefix. Click **OK**.
- 6 Select the **Display scanner dialog box** check box in the **Scan or Get Photo** panel.

- Click the **Scan** button.
The scanner setup dialog box appears.

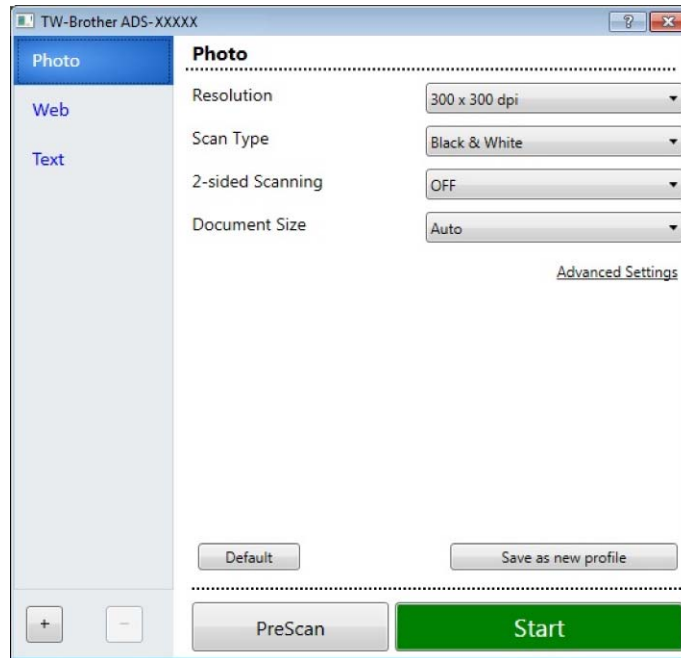

- Adjust the settings in the scanner setup dialog box if needed (**Resolution**, **Scan Type**, **2-sided Scanning**, and **Document Size**).
 - For more information about *TWAIN Driver Settings*, see page 130.
 - For more information about *WIA (Ver 1) Driver Settings*, see page 141.
- From the **Document Size** drop-down list, select your document size.

NOTE

After you select a document size, you can adjust the scanning area further by clicking the left mouse button and dragging it. This is required when cropping an image for scanning.

- Click the **Start** button.
The machine starts scanning.

TWAIN Driver Settings

■ Basic screen

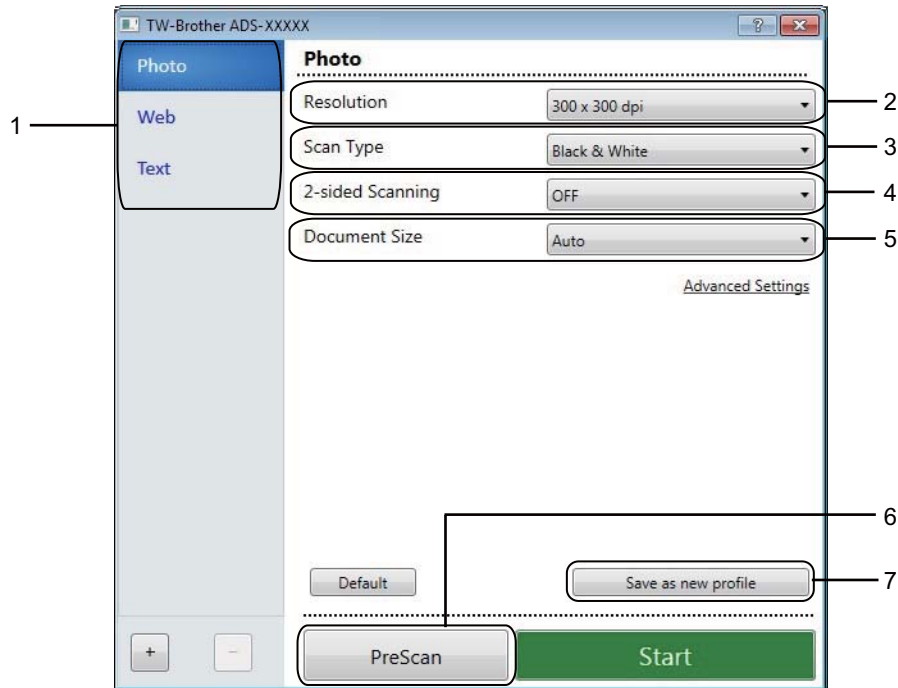

1 Scan (Image Type) Profiles

Select **Photo**, **Web**, or **Text**.

Add new items by clicking . Although you cannot change the name of **Photo**, **Web** and **Text**, you can change the name of new items.

Scan (Image Type)		Resolution	Scan Type
Photo	Use for scanning photo images	300 x 300 dpi	24bit Color
Web	Use for attaching the scanned image to web pages	100 x 100 dpi	24bit Color
Text	Use for scanning text documents	200 x 200 dpi	Black & White

2 Resolution

Select a scanning resolution from the **Resolution** drop-down list. Higher resolutions take more memory and transfer time, but produce a finer scanned image.

Resolution
100 x 100 dpi
150 x 150 dpi
200 x 200 dpi
300 x 300 dpi
400 x 400 dpi
600 x 600 dpi
1,200 x 1,200 dpi

3 Scan Type

Select one of the following:

■ Auto

Automatically detects whether the document uses color and generates a scanned image of it. For documents that mix color and black and white pages, color pages will be scanned in Color mode, while black and white pages will be scanned in Black & White mode.

■ Black & White

Use for text or line art images.

■ Gray (Error Diffusion)

Use for photographic images or graphics. (Error Diffusion is a method for creating simulated grayscale images without using true gray dots. Black dots are put in a specific pattern to give a gray appearance.)

■ True Gray

Use for photographic images or graphics. This mode is more exact due to using up to 256 shades of gray.

■ 24bit Color



Uses up to 16.8 million colors to scan the image. Although using **24bit Color** creates an image with the most accurate color reproduction, it requires the most memory and has the longest transfer time.

NOTE

The **Contrast** setting is only available when setting **Scan Type** to **Gray (Error Diffusion)**, **True Gray** or **24bit Color** or **Auto**.

4 2-sided Scanning

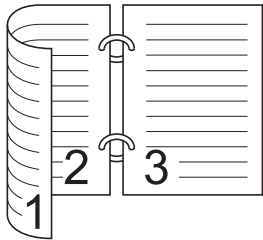
Select **Long-edge binding** or **Short-edge binding** depending on the layout of your original to make sure that the data file created appears correctly in the scanned document.

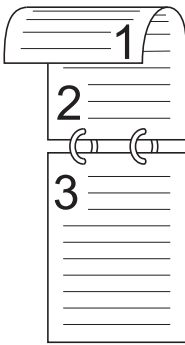
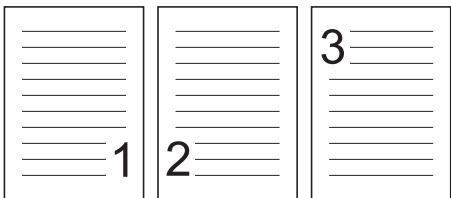
2-sided Scan Setting	Original Layout	Scan Result
Long-edge binding		
Short-edge binding		

5 Document Size

Document size is set to **Auto** by default. For faster scan speeds, select the exact size of your document from the **Document Size** drop-down list. If you select **Custom**, the **Custom Document Size** dialog box appears so you can specify the document size.

6 PreScan

Click **PreScan** to preview your image and crop unwanted portions before scanning.

Cropping is available in these settings:

- 2-sided scanning: Off
- Auto Deskew: Off
- Multifeed Detection: Off
- Document Size: a scan size other than **Auto** and **Long Paper**

7 Save as new profile

Click **Save as new profile** to save your frequently-used scan settings.

The following settings will be saved as part of the profile:

- Settings configured on the Basic screen
- Settings configured using the **Advanced Settings** link
- The scan boundaries as specified on the preview image

You can create up to 64 profiles.

Created profiles will be added to the **Scan or Get Photo** panel. To edit a profile, click **Settings** on the **Scan or Get Photo** panel. To delete a profile, click **Delete**.

■ Advanced Settings

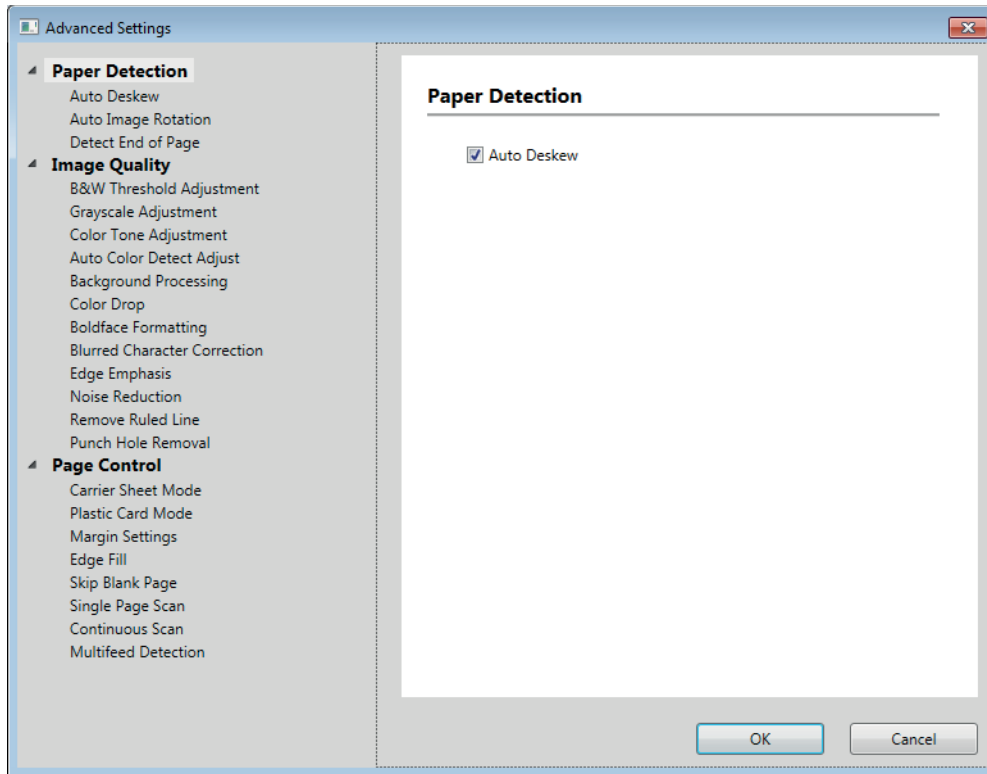

Paper

1 Auto Deskew

Corrects the skew of the scanned data.

NOTE

- If you enable **Carrier Sheet Mode**, you cannot enable **Auto Deskew**.
- This function is not effective with **Long Paper** document size or the **Carrier Sheet Mode**.

2 Auto Image Rotation

Changes the direction of the document based on the text orientation.

NOTE

This function is not effective with **Long Paper**.

3 Detect End of Page

Detects end of page and automatically adjusts the size of a page when the length of the document is shorter than the **Document Size** selected.

NOTE

If you enable **Carrier Sheet Mode**, you cannot enable **Detect End of Page**.

Enhancement

1 B&W Threshold Adjustment

This setting allows you to adjust the image quality when scanning in **Black & White** mode.

Larger values will increase the amount of black in the scanned image, while smaller values will increase the amount of white.

NOTE

This function is available when the **Black & White** scan type is selected.

2 Grayscale adjustment

This function adjust the brightness and contrast to create a grayscale image.

■ Brightness

Larger values lighten the image.

■ Contrast

Larger values increase the contrast in the image. Excessively large values will result in a black and white image.

NOTE

This function is available when the **Gray (Error Diffusion)** scan type is selected.

3 Color Tone Adjustment

Allows you to adjust the brightness, contrast, shadow, highlight, and gamma during grayscale and color scanning.

The default setting is **Custom**.

■ Auto

Scans the document using the optimal settings based on its content.

■ Custom

Allows you to set the **Brightness**, **Contrast**, **Shadow**, **Highlight** and **Gamma** manually.



Original



Brightness: 25
Contrast: 25
Shadow: 122
Highlight: 240
Gamma: 5.0

NOTE

- **Shadow** cannot be set to a larger value than **Highlight**.
- This function is available when the **Auto**, **True Gray**, or **24bit Color** scan type is selected.
- This function is not effective for the **Long Paper** document size.

4 Auto Color Detect Adjust

When scan type **Auto** is selected you can adjust the detection level of color, B&W and grayscale.

■ B&W/Gray - Color

Increasing the slider value will make the machine more likely to determine that a given document is a color document when detecting whether the document uses color. Decreasing the value will make the machine more likely to determine that a given document is a black and white or grayscale document.

■ B&W - Gray

Increasing the slider value will make the machine more likely to determine that a given document is a grayscale document when detecting whether the document uses color. Decreasing the value will make the machine more likely to determine that a given document is black and white.

5 Background Processing

■ Remove Bleed-through / Pattern

Enabling this function prevents the Bleed Through phenomenon on a two-sided document.

■ Remove Background Color

If you enable the **Remove Background Color** setting, this machine remove the base color of documents such as newspapers to make the scanned data more recognizable.

■ **Level**

Adjusts the strength of the **Remove Bleed-through / Pattern** and **Remove Background Color** effects. This setting is available when the **Auto** scan type is selected.

NOTE

This function is available when the **Auto**, **True Gray**, or **24bit Color** scan type is selected.

6 Color Drop

Deletes specific colors from your scanned data.

Select one of the following:

■ **Chromatic color**

Use to remove all colors except Black.

■ **Red**

Use to remove the Red color.

■ **Green**

Use to remove the Green color.

■ **Blue**

Use to remove the Blue color.

■ **Custom**

Select the color that you want to remove.

7 Boldface Formatting/Blurred Character Correction/Edge Emphasis

■ **Boldface Formatting**

This feature allows you to enlarge and thicken black areas of documents, making thin text thicker. It has the effect of thickening not only text, but all dots and lines. If both **Boldface Formatting** and **Blurred Character Correction** are enabled, only the **Boldface Formatting** function will be performed.

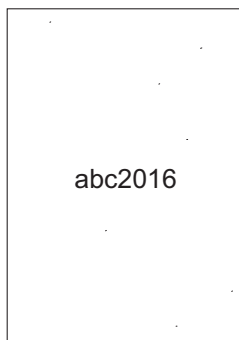

Normal

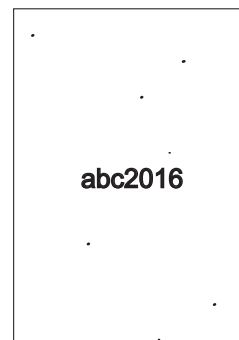

Boldface Formatting

NOTE

This function is available when the **Black & White** scan type is selected.

■ Blurred Character Correction

When there is faint or broken text in the scanned image, this feature causes the machine to combine the letters so that they are more readily detectable as text, causing not only text, but also black dots and lines to be combined. If both **Boldface Formatting** and **Blurred Character Correction** are enabled, only the **Boldface Formatting** function will be performed.

NOTE

This function is available when the **Black & White** scan type is selected.

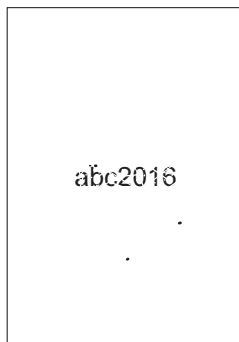

Normal

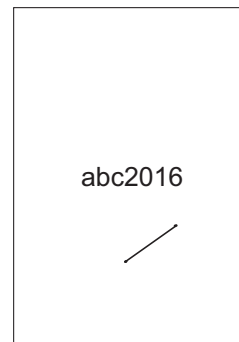

Blurred Character Correction

■ Edge Emphasis

This feature allows you to make blurred images and document or magazine text appear more clearly for improved visibility. Use the slider to adjust the strength of the **Edge Emphasis** effect.

NOTE

- This function is available when the **Auto**, **True Gray**, or **24bit Color** scan type is selected.
- This function is not effective for the **Long Paper** document size.

8 Noise Reduction

This feature allows you to remove small dots or specks called “noise”, from the background of scanned images. Removing unwanted speckles helps to reduce compressed file size.

NOTE

- This function is available when the **Black & White** scan type is selected.
- This function is not effective for the **Long Paper** document size.

9 Remove Ruled Line

This feature allows you to remove lines in the document. You can select the type of line direction to remove (**Vertical**, **Horizontal**, or **Vertical and Horizontal**). Angled lines will be detected as lines and removed if they are less than 0.36 in. (9 mm) from the center of the document to the edge of horizontal or vertical.

■ Minimum Line Length

Lines whose length is greater than or equal to the specified length will be removed.

■ Maximum Clearance

If lines are broken, for example due to fading of the image, lines that are broken for an interval that is less than or equal to the specified broken line distance will be detected as lines and removed.

NOTE

- This function is available when the **Black & White** scan type is selected.
- This function is not effective for the **Long Paper** document size.



When there is a Horizontal line

Horizontal line is not gone



When there is a vertical line shorter than 2 cm

The vertical line is not gone



When there is a break below 5 mm between vertical lines longer than 2 cm

The vertical line is gone



When there is a 5 mm or more break between vertical line longer than 2 cm and shorter than 2 cm

The vertical line shorter than 2 cm is not gone

10 Punch Hole Removal

This feature removes the punch hole markings by filling hole marks with white or the surrounding color.

■ White

Fill punch hole with white.

■ Surrounding color

Fill punch hole with the color surrounding the hole.

Paper Handling

1 Carrier Sheet Mode

Scan the following document types using the Carrier Sheet.

- Important documents (photos, contracts)
- Thin paper (receipts)
- Irregularly-shaped paper (clippings)

NOTE

- For this mode, you can select any settings other than **Auto** and **Long Paper** document size.
 - If you enable **Multifeed Detection** or **Plastic Card Mode**, you cannot enable **Carrier Sheet Mode**, **Auto Deskew** or **Detect End of Page**.
-

2 Plastic Card Mode

Scan cards, such as driver's licenses or insurance cards, using these automatic settings:

- Resolution: 600 x 600 dpi
- Document Size: 2 in 1(Auto)
- 2-sided Scanning: On (Short-edge binding)
- Auto Deskew: On
- Detect End of Page: Off
- Auto Image Rotation: Off
- Multifeed Detection: Off
- Carrier Sheet Mode: Off

3 Margin Settings

This feature allows you to add or remove a specific margin (-0.12 to 0.12 in. (-3 to 3 mm)) at the edge of the image.

4 Edge Fill

Select **White** or **Black** and set a value to add a white or black edge around the border of your scanned image.

5 Skip Blank Page

Removes blank pages of the document from the scanning results.

The sensitivity of the **Skip Blank Page** function can be adjusted with the slider. Moving the slider toward **High** will make the machine more likely to skip pages, while moving it toward **Low** will make the machine less likely to skip pages. If you enable the **Show Results** setting, the computer will display how many blank pages were skipped once the scan is complete.

If the **Skip Blank Page** function is triggered for all document pages, no scanned image will be displayed. Instead, the computer will display a warning message indicating that all document pages are blank.

6 Continuous Scan

This feature allows you to scan additional documents using the same settings once a scan completes. It is convenient to use when you scan more documents the maximum capacity of the ADF or when you scan several documents at once.

7 Multifeed Detection

When this function detects a multifeed, the computer will display an error message. Confirm that the data scanned before the multifeed has been saved, and then start scanning again at the next page or the beginning of the document.

NOTE

- Enabling this function may cause detection of a multifeed when scanning thick paper. Disable this setting when scanning thick paper.
 - If you enable **Carrier Sheet Mode** or **Plastic Card Mode**, you cannot enable **Multifeed Detection**.
-

8 Single Paper Scan

One sheet scan will feed one page at a time from the ADF regardless of the number of pages in the ADF.

WIA (Ver 1) Driver Settings

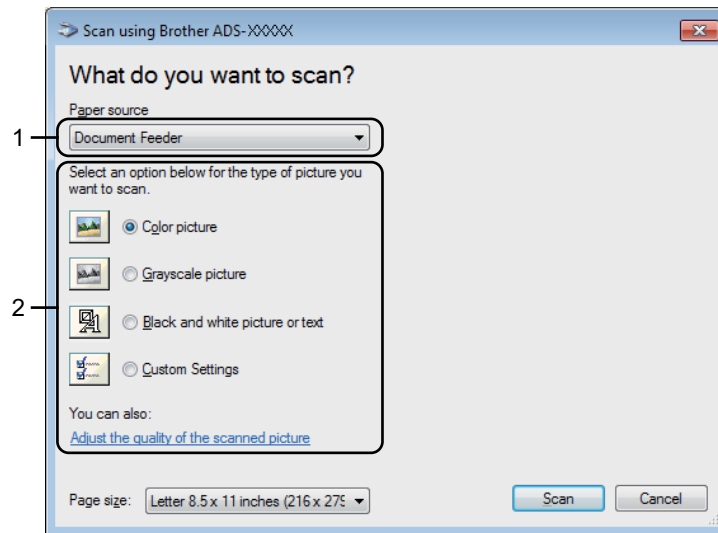

1 Paper source

You can select only **Document Feeder**.

2 Picture Type (Image Type)

Select **Color picture**, **Grayscale picture**, **Black and white picture or text**, or **Custom Settings**.

To change advanced settings, click **Adjust the quality of the scanned picture**.

■ Resolution

Select a scanning resolution from the **Resolution** text box. Higher resolutions take more memory and transfer time, but produce a finer scanned image.

■ Brightness

Adjust the setting (-50 to 50) to get the best image. The default value of 0 represents an average and is suitable for most images. Set the **Brightness** level by dragging the slider to the right or left to lighten or darken the image. You can also enter a value in the box to set the level. If the scanned image is too light, set a lower Brightness level and scan the document again. If the image is too dark, set a higher Brightness level and scan the document again.

■ Contrast

Adjust the setting (-50 to 50) to get the best image. The default value of 0 represents an average and is suitable for most images. Increase or decrease the contrast level by moving the slider to the right or left. An increase emphasizes dark and light areas of the image, while a decrease reveals more details in gray areas. You can also enter a value in the box to set the **Contrast**.

Scan Using Windows® Photo Gallery or Windows® Fax and Scan

You can use the Windows® Photo Gallery or Windows® Fax and Scan applications for scanning. These applications use the WIA scanner driver. The steps below will guide you through the scanning operations. You may have to download Windows® Photo Gallery or Windows® Fax and Scan.

- 1 Load your document.
- 2 Open your software application to scan the document. Do one of the following:
 - Windows® Photo Gallery
 - 1 Click **File**, then **Import from Camera or Scanner**.
 - 2 Select the scanner you want to use.
 - 3 Click the **Import** button.
The settings dialog box appears.
 - Windows® Fax and Scan
Click **File > New > Scan**.
The settings dialog box appears.

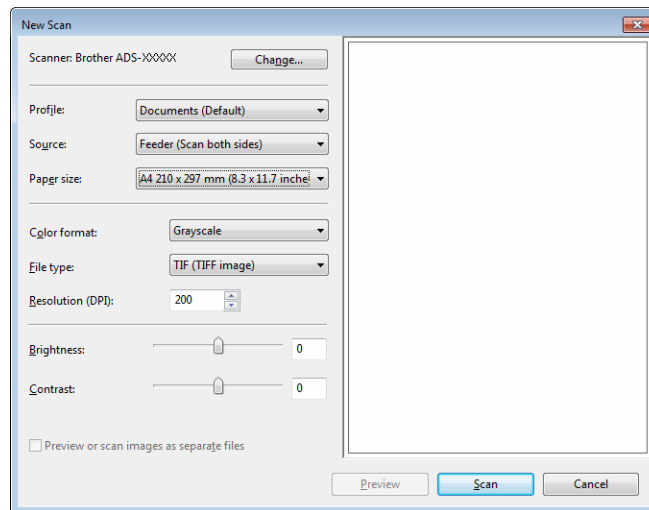

Profile

Profiles can be used to save settings, such as Page Size, Source, Format, and others.

- 3 Adjust the settings in the settings dialog box if needed.

NOTE

To save your settings, click the **Profile** drop-down arrow and select **Add Profile**.

- 4 Click the **Scan** button.
The machine starts scanning.

Use ABBYY FineReader

You can use the ABBYY FineReader application for scanning. It converts the scanned data to editable format such as Microsoft® Word, Microsoft® Excel, Adobe® PDF, html and EPUB.

See the ABBYY FineReader Help menu for more information about using ABBYY FineReader.

Scan Using TWAIN Applications (Macintosh)

The bundled applications cannot change TWAIN settings. However, you can use other applications such as Presto! PageManager and Adobe Photoshop to configure TWAIN settings. The below instructions are for Presto! PageManager, but are similar for other Macintosh applications.

Scan Using TWAIN Applications (for example, Presto! PageManager)

- 1 Start Presto! PageManager by double-clicking the Presto! PageManager icon on your computer screen.

NOTE

The first time you use the Brother TWAIN driver, set it as the default driver:

- 1 Click **File > Select Source**.
- 2 Select **Brother TWAIN**.

- 2 Click **File > Acquire Image Data**.
The scanner setup dialog box appears.

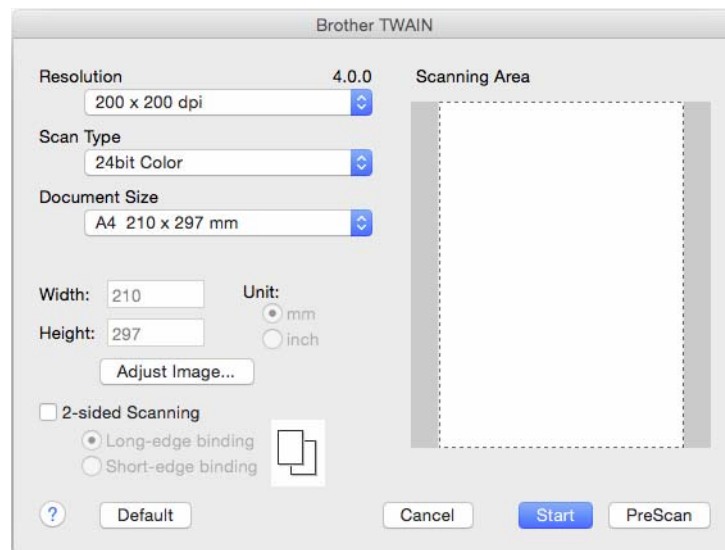

(The Brother TWAIN screen supports languages specified in TWAIN-compliant application you use.)

- 3 Adjust the settings in the scanner setup dialog box if needed.
- 4 From the **Document Size** pop-up menu, select your document size.

NOTE

After you select a document size, you can adjust the scanning area further by clicking the left mouse button and dragging it. This is required when cropping an image for scanning.

- 5 Click the **Start** button.
The machine starts scanning.

TWAIN Driver Settings

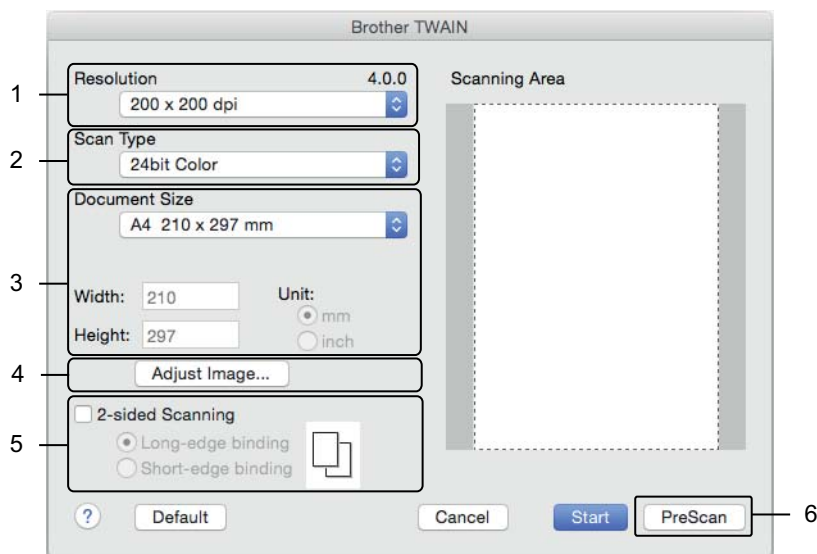

(The Brother TWAIN screen supports languages specified in TWAIN-compliant application you use.)

1 Resolution

Select a scanning resolution from the **Resolution** pop-up menu. Higher resolutions take more memory and transfer time, but produce a finer scanned image.

2 Scan Type

Select one of the following:

■ Black & White

Use for text or line art images.

■ Gray (Error Diffusion)

Use for photographic images or graphics. (Error Diffusion is a method for creating simulated grayscale images without using true gray dots. Black dots are put in a specific pattern to give a gray appearance.)

■ True Gray

Use for photographic images or graphics. This mode is more exact due to using up to 256 shades of gray.

■ 24bit Color

Uses up to 16.8 million colors to scan the image. Although using **24bit Color** creates an image with the most accurate color reproduction, it requires the most memory and has the longest transfer time.

3 Document Size

Document size is set to **Letter** by default. If you select **Custom**, specify the document size.

4 Adjust Image

Click the **Adjust Image** button for adjusting the image.

■ **Brightness**

Adjust the setting (-50 to 50) to get the best image. The default value of 0 represents an average and is suitable for most images. Set the **Brightness** level by dragging the slider to the right or left to lighten or darken the image. You can also enter a value in the box to set the level. If the scanned image is too light, set a lower Brightness level and scan the document again. If the image is too dark, set a higher Brightness level and scan the document again.

■ **Contrast**

Adjust the setting (-50 to 50) to get the best image. The default value of 0 represents an average and is suitable for most images. Increase or decrease the contrast level by moving the slider to the right or left. An increase emphasizes dark and light areas of the image, while a decrease reveals more details in gray areas. You can also enter a value in the box to set the **Contrast**.

NOTE



The **Contrast** setting is only available when setting **Scan Type** to **Gray (Error Diffusion)**, **True Gray** or **24bit Color**.

■ **Reduce Noise**

You can improve and enhance the quality of your scanned images with this selection. The Reduce Noise setting is available when using **24bit Color** and scan resolutions of 300 × 300 dpi, 400 × 400 dpi or 600 × 600 dpi.

5 2-sided Scanning

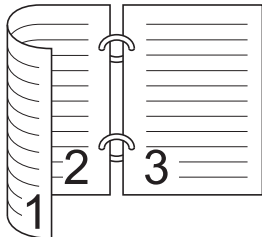
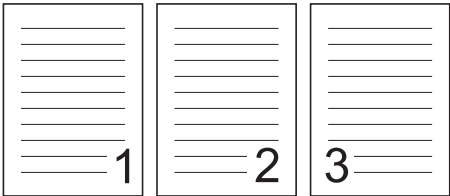
Select **Long-edge binding** or **Short-edge binding** depending on the layout of your original to make sure that the data file created appears correctly in the scanned document.

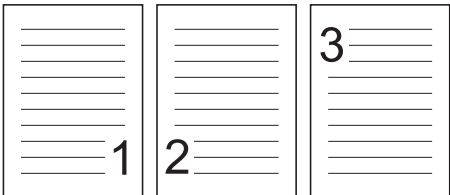
2-sided Scan Setting	Original Layout	Scan Result
<p>Long-edge binding</p>		
<p>Short-edge binding</p>		

6 PreScan

Click **PreScan** to preview your image and crop unwanted portions before scanning. Cropping is available when 2-sided scanning setting is Off.

Scan Using Apple Image Capture (ICA Driver)

You can scan a document using the ICA driver. If you installed the Full Driver & Software Package from the Brother Solutions Center (support.brother.com), the ICA driver has been already installed on your computer. You can also scan directly using the **Image Capture** application.

Scan Using Apple Image Capture

- 1 Launch the **Image Capture** application.



- 2 Select the machine from the list on the left side of the window.
You will see the machine in the **DEVICES** area. If connected via wireless (ADS-2800W / ADS-3600W) or Ethernet LAN, you will see it in the **SHARED** area.

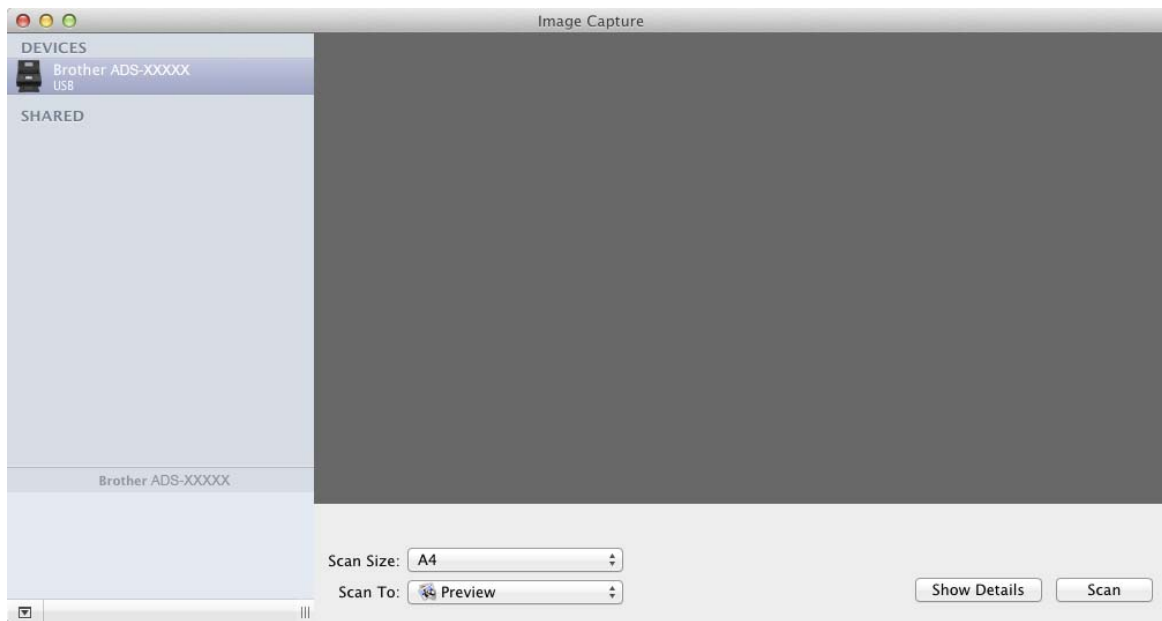

- 3 Load your document.
- 4 Select a size of your document for **Scan Size**.
- 5 Select the destination folder or destination application for **Scan To**.
- 6 Click the **Scan** button.
The machine starts scanning.

ICA Driver Settings

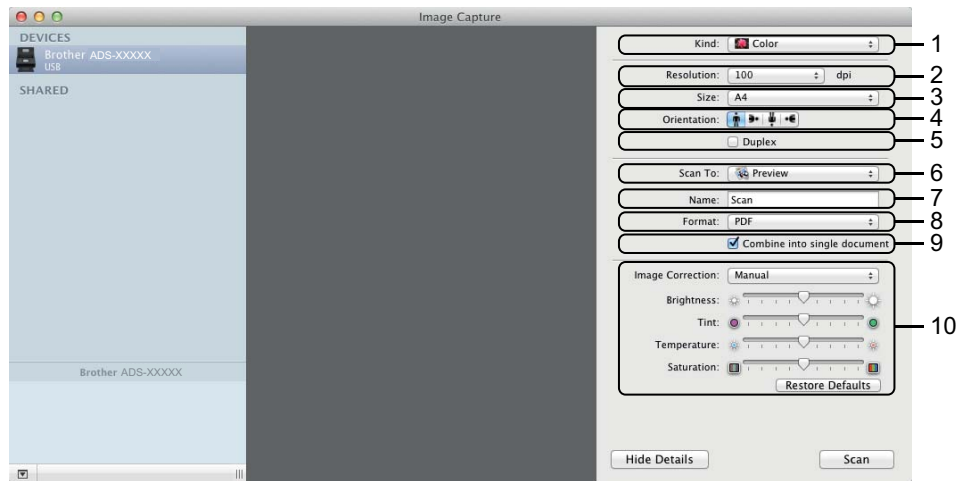

Click the **Show Details** button to adjust the following settings, if needed. Note that the item name and assignable value will vary depending on the machine.

1 Kind

Select from **Color**, **Black & White** or **Text**.

2 Resolution

Select the resolution you want to scan your document at.

3 Scan Size or Size

Select the paper size of the document.

4 Orientation

Select the orientation of the document.

5 Duplex

Select the **Duplex** check box to do 2-sided (duplex) scanning.

6 Scan To

Select the destination folder or destination application.

7 Name

Enter the prefix text used for the name of the scanned image.

8 Format

Select the file format of the scanned data.

9 Combine into single document

Check this box to scan a document as one item and save it as one file when selecting PDF or TIFF for the file format.

10 Image Correction

You can configure settings depending on the **Kind** that you have chosen.

Kind	Configurable Settings
Color	Brightness, Tint, Temperature, Saturation
Black & White	Brightness, Contrast
Text	Threshold

Save Scanned Documents on Your Computer in Home Mode

(ADS-2400N / ADS-3000N)

- 1 Start the ControlCenter application.
 - Windows®
 - a Click the  (ControlCenter4) icon in the task tray and then select **Open** from the menu. The **ControlCenter4** window appears.
 - b Click the **Device Settings** tab (the example below uses **Home Mode**).

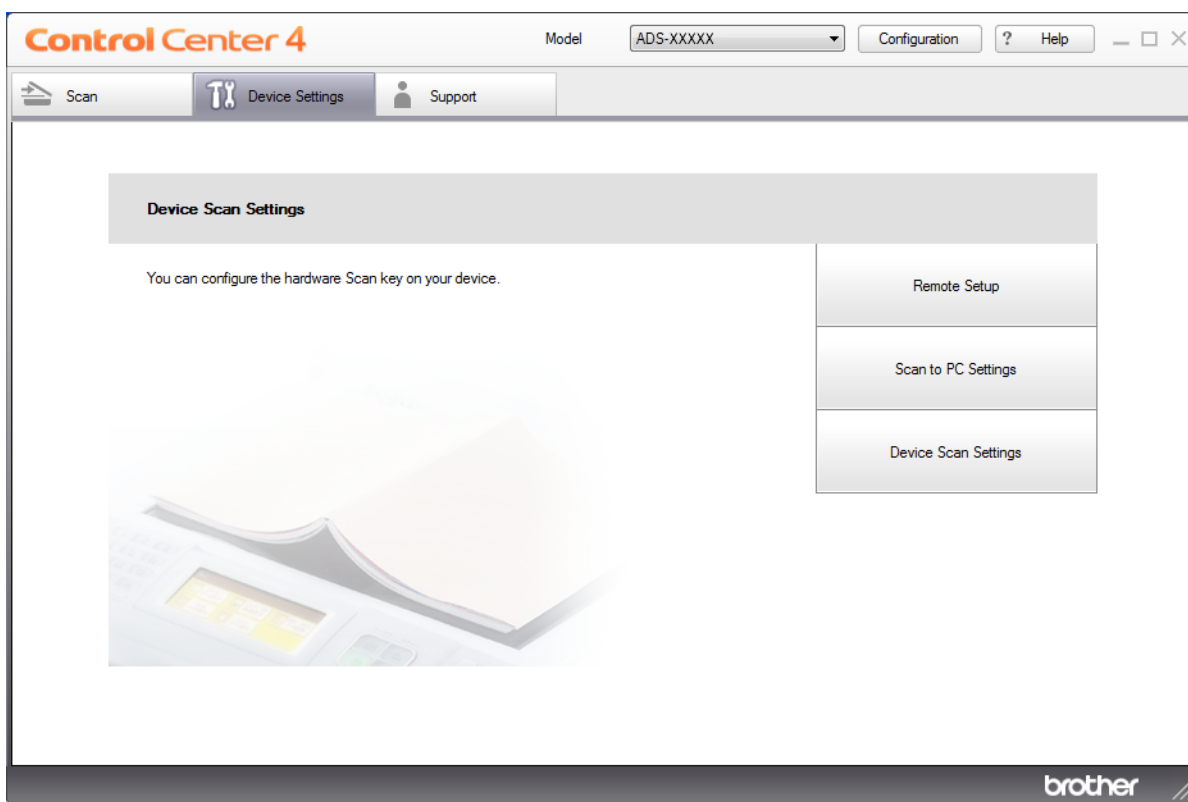

- Macintosh
 - a Click the  (ControlCenter2) icon in the Dock. The **ControlCenter2** window appears.

- b Click the **DEVICE SETTINGS** tab.

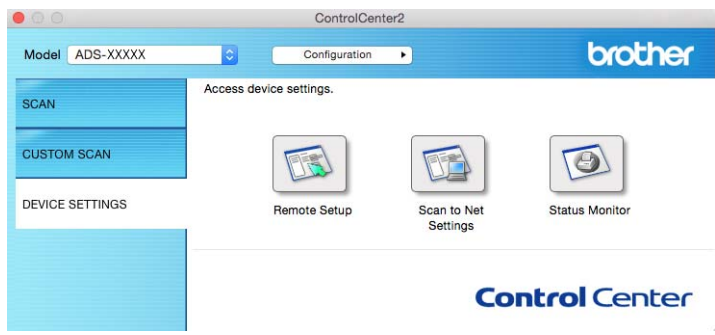

- 2 Click the **Remote Setup** button. The Remote Setup window appears.

- Windows®

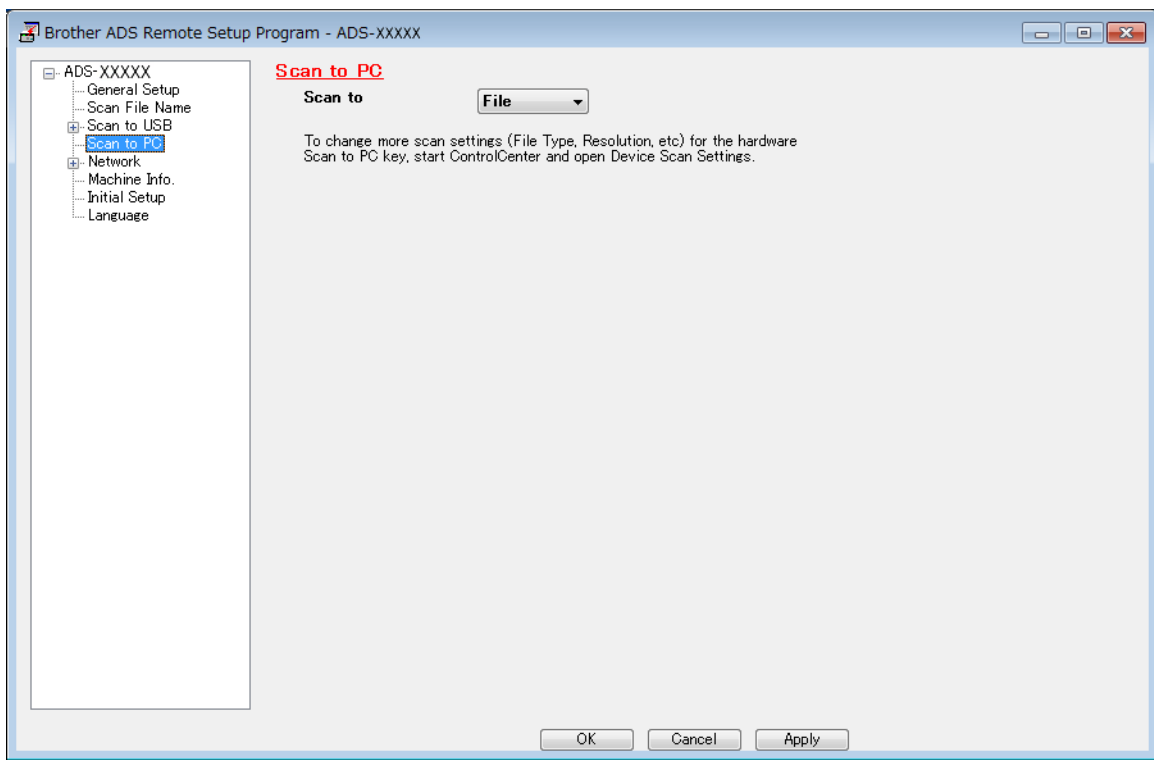

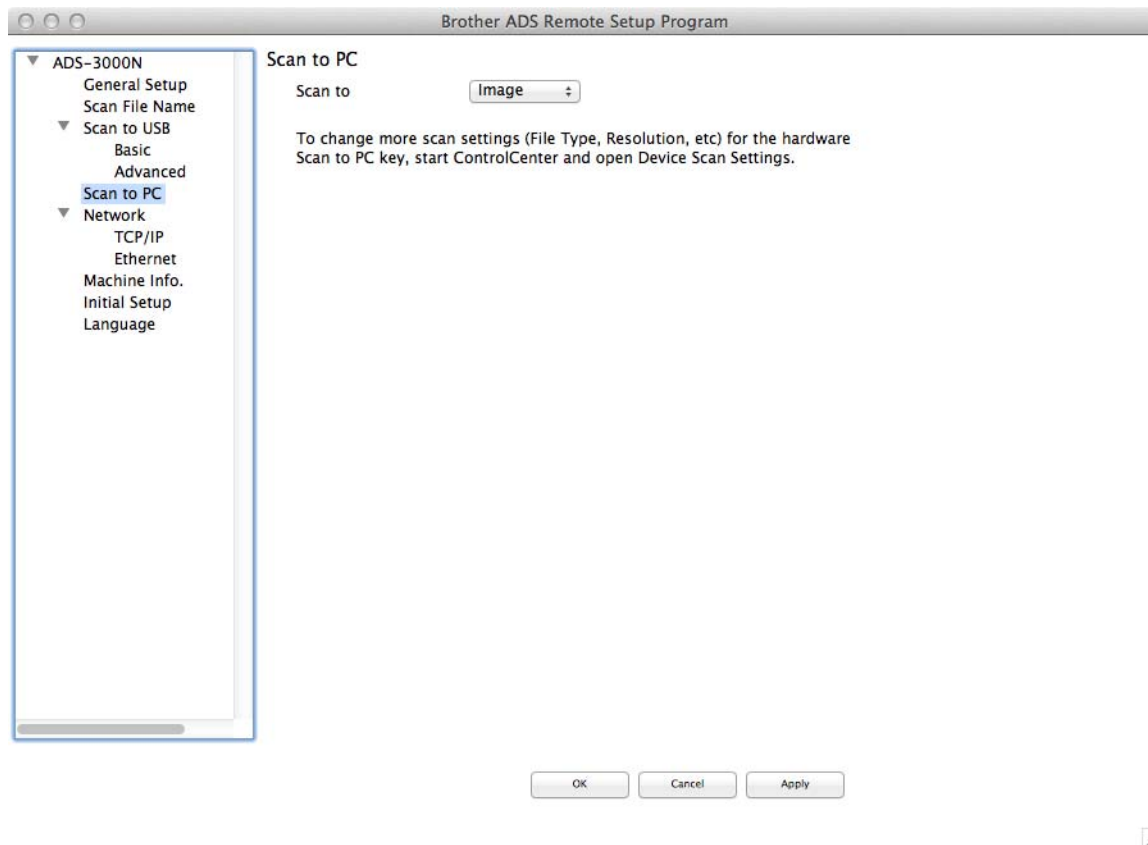

■ Macintosh



- 3 Select a Scan-to action you want to assign (**Image**, **OCR**, **E-mail**, or **File**) from the pop-up menu.
- 4 Click **OK** to close the Remote Setup window.
- 5 Change other settings if needed (see *Change Scan to PC Settings (Windows®)* on page 212 or *Change Scan to PC Settings (Macintosh)* on page 220).
- 6 Load your document.
- 7 Press **Scan to PC**. The machine scans the document.

Save Scanned Documents on Your Computer in Advanced Mode

(ADS-2400N / ADS-3000N)

- 1 Start the ControlCenter application.
 - Windows®
 - a Click the  (ControlCenter4) icon in the task tray and then select **Open** from the menu. The **ControlCenter4** window appears.
 - b Click the  tab (the example below uses **Advanced Mode**).



■ Macintosh

- a Click the  (ControlCenter2) icon in the Dock. The **ControlCenter2** window appears.
- b Click the **DEVICE SETTINGS** tab.

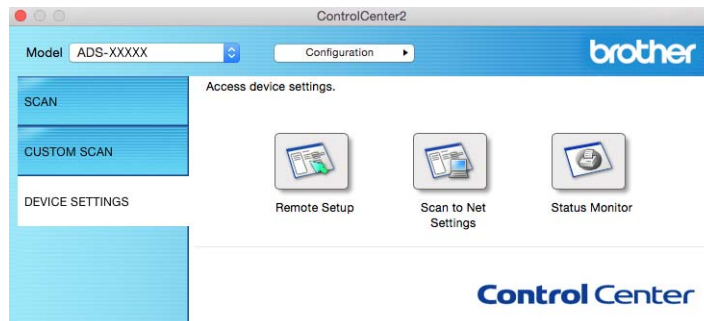

- 2 Click the **Scan to PC** button. The Remote Setup window appears (the example below uses Windows®).

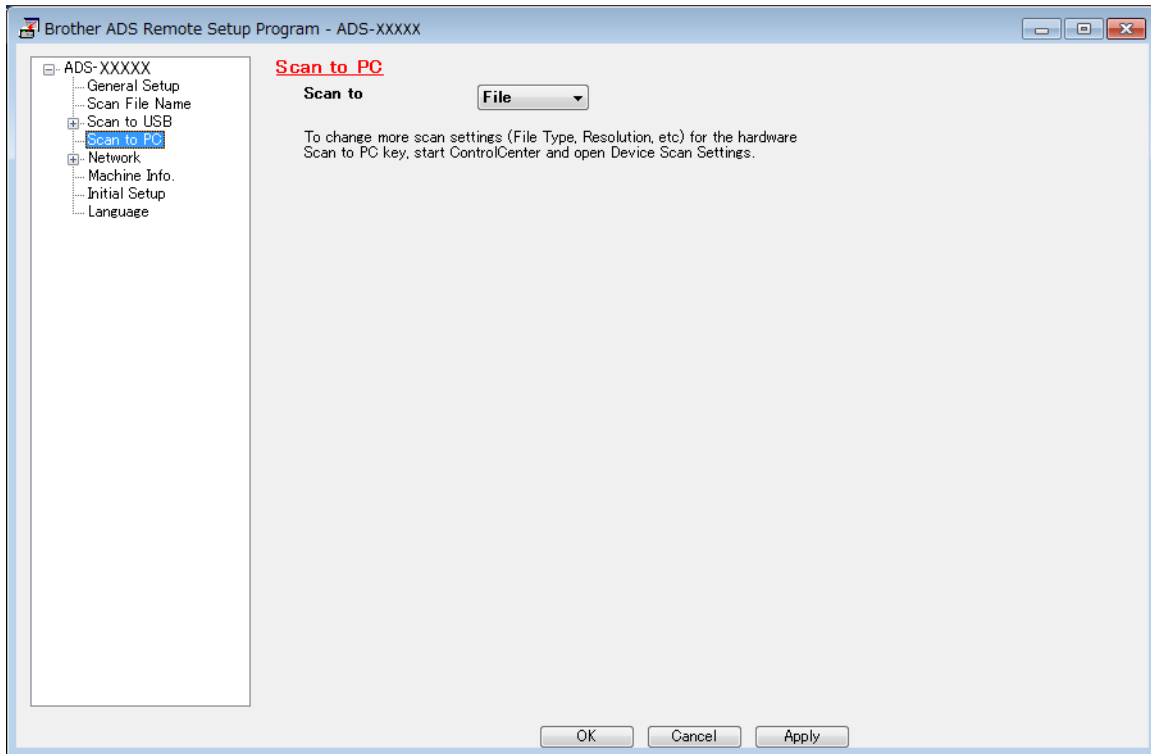

- 3 Select a Scan-to action you want to assign (**Image**, **OCR**, **E-mail**, or **File**) from the pop-up menu.
- 4 Click **OK** to close the Remote Setup window.
- 5 Change other settings if needed (see *Change Scan to PC Settings (Windows®)* on page 212 or *Change Scan to PC Settings (Macintosh)* on page 220).
- 6 Load your document.
- 7 Press **Scan to PC**. The machine scans the document.

(ADS-2800W / ADS-3600W)

- 1 Load your document.
- 2 Swipe left or right, or press ◀ or ▶ to display Scan 1.
- 3 Press to PC.
- 4 Swipe left or right to display the Scan-to action you want to do (to OCR, to File, to Image or to E-mail).
- 5 Press the Scan-to action you want to do and then OK.
- 6 Press Options.
 - 7 Configure the following settings as needed. To configure more detailed settings, press Advanced Settings. For more information see page 227. Press OK.
 - 2-sided Scan
 - Scan Settings
 - Scan Type
 - Resolution
 - File Type
 - Document Size
 - Auto Deskew
 - Skip Blank Page
 - Advanced Settings
- 8 If multiple computers are connected to the machine, press ▲ or ▼ to display the destination computer you want.
Press the destination computer.
- 9 Press Start.
The machine starts the scanning process.

NOTE

- You can configure the Scan-to settings from your computer. See *Change Scan to PC Settings (Windows®)* on page 212 or *Change Scan to PC Settings (Macintosh)* on page 220.
- To save the settings as a shortcut, press Save as Shortcut. For more information, see *Adding Scan Shortcuts* on page 12.

Save Scanned Documents on a USB Flash Drive

(ADS-2400N / ADS-3000N / ADS-2800W / ADS-3600W)

- 1 Start the ControlCenter application.
 - Windows®
 - a Click the  (ControlCenter4) icon in the task tray and then select **Open** from the menu. The **ControlCenter4** window appears.
 - b Click the **Device Settings** tab (the example below uses **Home Mode**).

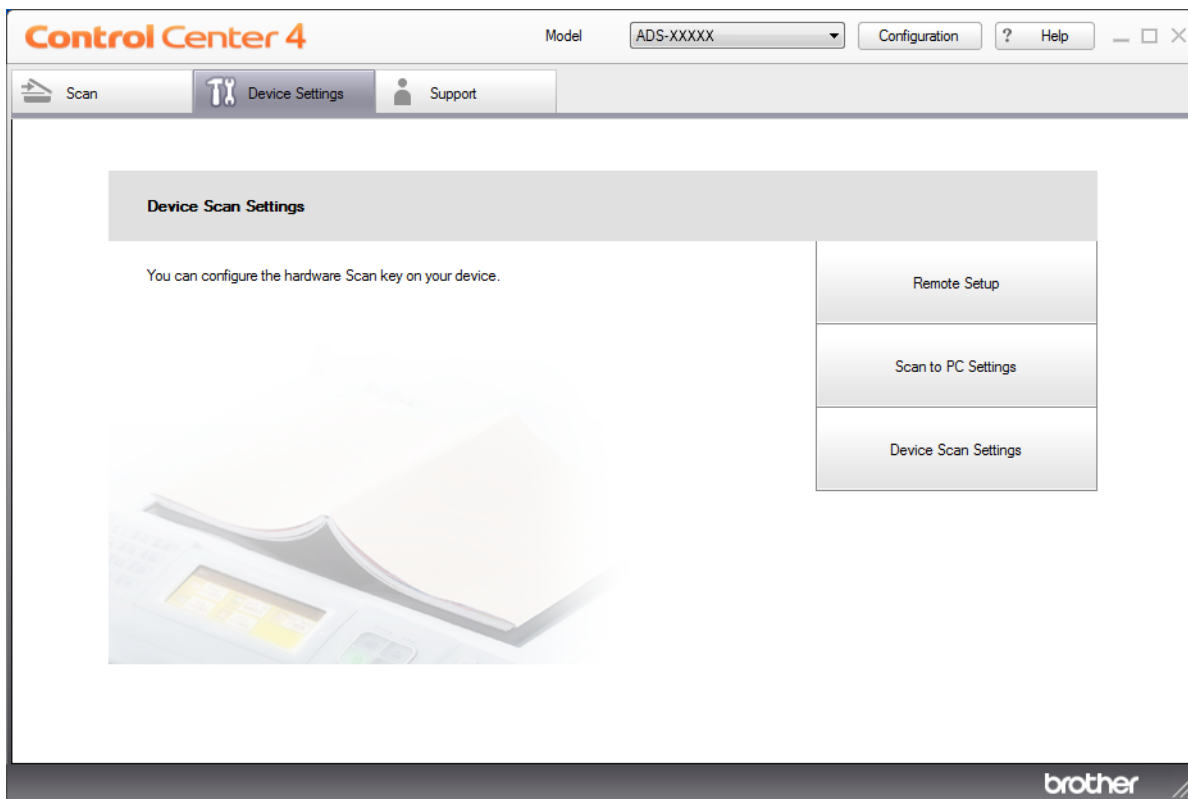

NOTE

If using **Advanced Mode**, click the  (Settings) icon to access **Device Settings**.



7

■ Macintosh

- a Click the  (ControlCenter2) icon in the Dock. The **ControlCenter2** window appears.
- b Click the **DEVICE SETTINGS** tab.

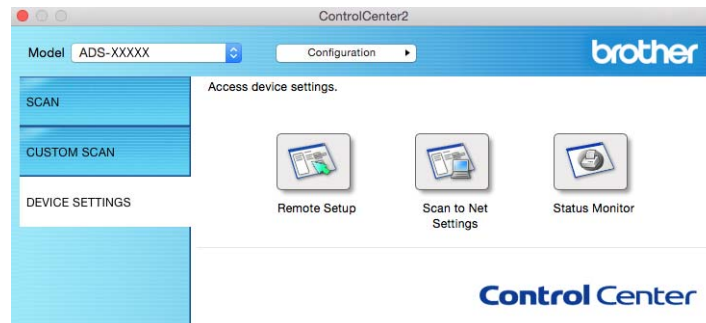

- 2 Click the **Remote Setup** button. The Remote Setup window appears.

- 3 Select **Scan to USB** in the folder tree and then configure scan settings as needed (the example below uses Windows®).

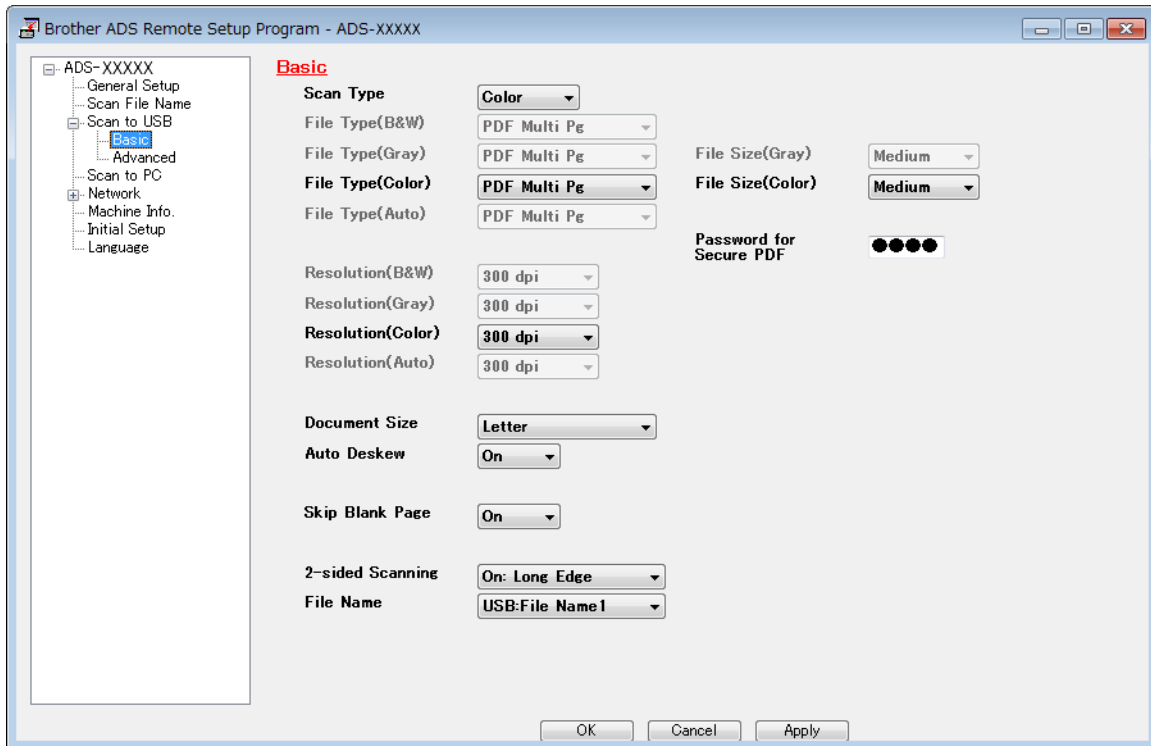

- 4 Click **Apply** and then **OK**.
- 5 Insert a USB flash drive into the machine.
- 6 Load your document.
- 7 Press **Scan to USB** on the control panel. The machine starts scanning.

NOTE

The file name will be the current date plus a two-digit sequential number.

(ADS-2800W / ADS-3600W)

- 1 Insert a USB flash drive into your machine.
- 2 Load your document.
- 3 Swipe left or right, or press ◀ or ▶ to display Scan 3.
- 4 Press to USB.
- 5 Press Options.
 - 2-sided Scan
 - Scan Type
 - Resolution
 - File Type
 - Document Size
 - File Name
 - File Size
 - Auto Deskew
 - Skip Blank Page
 - Advanced Settings

NOTE

- To select Long Paper (up to 196.85in) for Document Size, use the following settings:
Scan Type: Color OR Black & White
- To save the settings as a new default, press Set New Default.
- To restore all settings to the factory settings, press Factory Reset.

-
- 7 Press Start.
The machine scans the data and saves it on the USB flash drive.

NOTE

To save the settings as a shortcut, press Save as Shortcut. For more information, see *Adding Scan Shortcuts* on page 12.

IMPORTANT

DO NOT remove the USB flash drive while the machine is scanning to the USB flash drive to avoid damaging the drive or the data stored on it.

Save Scanned Documents on Mobile Devices

The machine can save the scanned data on a mobile device.

NOTE

- This feature can be used with mobile devices that use the USB mass storage standard.
- The machine does not support charging any USB devices.
- Brother Image Viewer for Android™, which is available for download from the Google Play (Android™ Market), enables users to view or edit the scanned data. For more information, download the Brother Image Viewer for Android™.

- 1 Connect the machine to a mobile device with the USB cable that came with your mobile device.

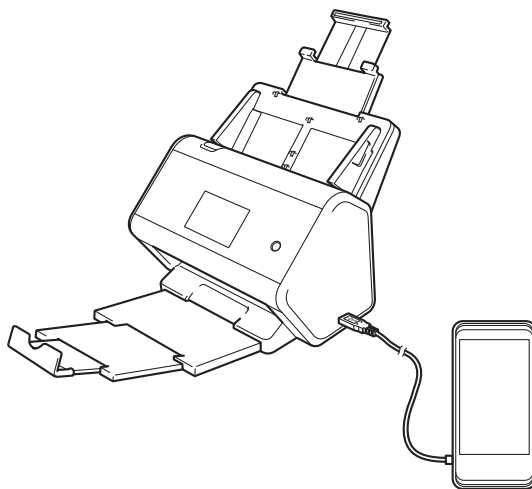

NOTE

The mobile device must be turned on before connecting to the machine.

- 2 Load your document.
 - If your machine is ADS-2400N / ADS-3000N, go to 3.
 - If your machine is ADS-2800W / ADS-3600W, go to 4.
- 3 (ADS-2400N / ADS-3000N)
Press the **Scan to USB** key. The machine starts scanning, and then the scanned data is saved on the mobile device.
- 4 (ADS-2800W / ADS-3600W)
 - a. Swipe left or right, or press ◀ or ▶ to display **Scan 3**.
 - b. Press **to USB**.
 - c. Press **Options**.
 - d. Configure the following settings as needed. To configure more detailed settings, press **Advanced Settings**. For more information see page 227.
 - 2-sided Scan
 - Scan Type

- Resolution
- File Type
- Document Size
- File Name
- File Name Style
- File Size
- Auto Deskew
- Skip Blank Page
- Advanced Settings

5 Press OK.

NOTE

- To save the settings as a new default, press `Set New Default`.
 - To restore all settings to the factory settings, press `Factory Reset`.
 - If the machine is turned on when you insert a USB flash drive, the `Options` screen appears automatically.
-

6 Press `Start`.

The machine starts scanning, and then the scanned data is saved on the mobile device.

NOTE

To save the settings as a shortcut, press `Save as Shortcut`. For more information, see *Adding Scan Shortcuts* on page 12.

Scan Documents to an FTP Server

When you choose Scan to FTP, you can scan a black and white or color document directly to an FTP server on your local network, or on the Internet.

The details required to use Scan to FTP can be entered by using Web Based Management to pre-configure and store the details in an FTP Profile.

NOTE

- Scan to FTP is available when FTP profiles are configured by using Web Based Management.
- We recommend Microsoft® Internet Explorer® 8/10/11 for Windows® and Safari 8.0 for Macintosh. Also make sure that JavaScript and Cookies are always enabled in whichever browser you use. If a different web browser is used, make sure it is compatible with HTTP 1.0 and HTTP 1.1.

Start Web Based Management

NOTE

To use Web Based Management you must set up the machine using the wireless (ADS-2800W / ADS-3600W) network method with the installation DVD-ROM (see the *Quick Setup Guide*).

(ADS-2400N / ADS-3000N)

- 1 Start the ControlCenter application.
 - Windows®
 - a Click the  (ControlCenter4) icon in the task tray and then select **Open** from the menu. The **ControlCenter4** window appears.

- b Click the **Device Settings** tab (the example below uses **Home Mode**).

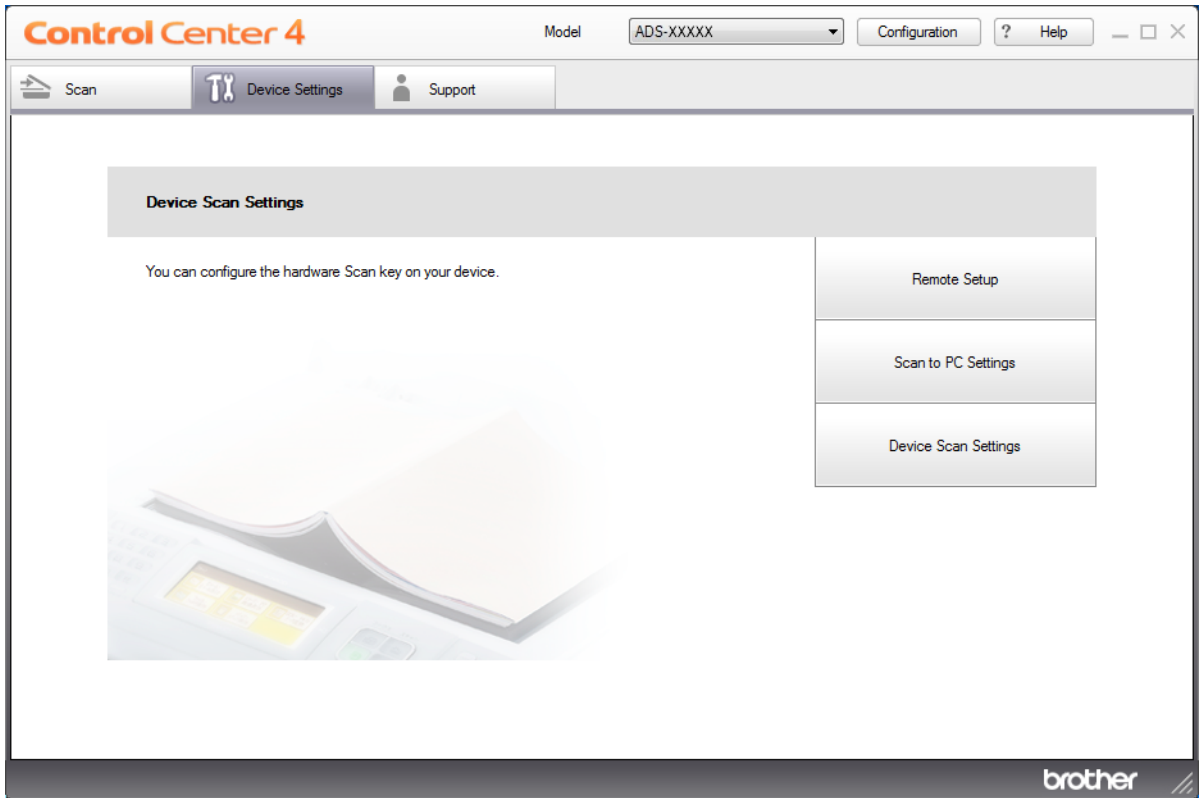

NOTE

If using **Advanced Mode**, click the  (Settings) icon to access **Device Settings**.



■ Macintosh

- a Click the  (ControlCenter2) icon in the Dock. The **ControlCenter2** window appears.
- b Click the **DEVICE SETTINGS** tab.



- 2 Click the **Scan to Net Settings** button. The Web Based Management window appears.

(ADS-2800W / ADS-3600W)

Start your web browser.

In your browser's address bar, type your machine's IP address (or your print server name). For example: <http://192.168.1.2>. You can use the machine's LCD to find its IP address. No password is required by default.

If you have previously set a password, type it, and then press .

Configure the FTP Default Settings

- 1 Click the **Scan** tab.
- 2 Click the **Scan to FTP/SFTP/Network/SharePoint** menu in the left navigation bar.
- 3 Select the **FTP** option, and then click **Submit**.
- 4 Click the **Scan to FTP/SFTP/Network/SharePoint Profile** menu in the left navigation bar.

- 5 Select the profile you want to set up or change.
- 6 In the **Profile Name** field, type a name for this server profile (up to 15 alphanumeric characters). This name is displayed in the **Destination** field when you click **Scan to Network Device** in the left navigation bar (ADS-2400N / ADS-3000N) or on the machine's Touchscreen (ADS-2800W / ADS-3600W).
- 7 In the **Host Address** field, type the Host Address (for example: ftp.example.com; up to 64 characters) or the IP address (for example: 192.23.56.189), and type the path (up to 60 characters) to the folder on the FTP server where you want to send your scanned data. Do not type a slash mark at the beginning of the path.
- 8 In the **Username** field, type the user name (up to 32 characters), that has permission to write data to the FTP server.
- 9 In the **Password** field, type the password (up to 32 characters) associated with the user name you entered in the **Username** field. Type the password again in the **Retype Password** field.
- 10 In the **Store Directory** field, enter the destination folder where your document will be stored on the FTP server (up to 60 characters).

- 11 Click the **File Name** drop-down list, and then select a file name prefix from the three preset names provided, or from fourteen user-defined names. The file name used for the scanned document will be the file name prefix you select, followed by the last six digits of the scanner counter and the file extension (for example: "Estimate_098765.pdf").
- 12 Select the Color or Black and White/Gray to adjust the detection level.
- 13 Choose the quality, file type, document size, file size, brightness, contrast and 2-sided Scan you want to use for the scanned data. The following settings can be changed.

Setting	Options	Description
Quality	Color 100 dpi Color 150 dpi Color 200 dpi Color 300 dpi Color 600 dpi Color Auto Gray 100 dpi Gray 150 dpi Gray 200 dpi Gray 300 dpi Gray 600 dpi Gray Auto B&W 100 dpi B&W 150 dpi B&W 200 dpi B&W 300 dpi B&W 600 dpi B&W Auto Auto 100 dpi Auto 150 dpi Auto 200 dpi Auto 300 dpi Auto 600 dpi Auto User Select	<ul style="list-style-type: none"> ■ You can select a scanning quality from the Quality drop-down list. Higher qualities take more memory and transfer time, but produce a finer scanned image. ■ If you select User Select, you must select the setting from the machine's control panel.

Setting	Options	Description
File Type	PDF Single-Page PDF Multi-Page JPEG PDF/A Single-Page PDF/A Multi-Page Secure PDF Single-Page Secure PDF Multi-Page Signed PDF Single-Page Signed PDF Multi-Page High Compression PDF Single-Page High Compression PDF Multi-Page XPS TIFF Single-Page TIFF Multi-Page User Select	<ul style="list-style-type: none"> ■ Select the file type you want to use for the scanned data. ■ If you select Secure PDF, the machine will ask you to enter a 4 digit password using numbers 0-9 before it starts scanning. ■ If you select Signed PDF, you must install a certificate to your machine using Web Based Management. Select Signed PDF from Administrator in Web Based Management. See the <i>Network User's Guide</i>. ■ PDF/A is a PDF file format intended for long-term archiving. This format contains all the necessary information to be able to reproduce the document after long-term storage. ■ Signed PDF helps prevent data tampering and the impersonation of an author by including a digital certificate within the document. ■ You can select PDF, Secure PDF, PDF/A, Signed PDF, JPEG or XPS when you select Color or Gray in Quality. ■ You can select PDF, Secure PDF, PDF/A, Signed PDF or TIFF when you select B&W in Quality. ■ You can select PDF, Secure PDF or Signed PDF when you select Auto in Quality. ■ If you select User Select, you must select the setting from the machine's control panel. ■ If you select High Compression PDF, you can select only Color 300dpi or Gray 300dpi.
Document Size	Auto A4 Letter Legal B5 A5 B6 A6 Business Card Long Paper User Select	<ul style="list-style-type: none"> ■ If you select Auto, scan documents of any size without making adjustments to Document Size. For faster scan speeds, select the exact size of your document from the Document Size drop-down list. ■ If you select 600 dpi for Quality, you cannot select Auto. ■ When Auto Deskew is set to Off, you can select A4, Letter, Legal, B5, A5, B6, A6, Business Card or Long Paper (when Auto XXX dpi is not selected as the Quality). ■ You can select Long Paper when you choose the following settings: <ul style="list-style-type: none"> • Quality: other than Auto • Auto Deskew: Off • Skip Blank Page: Off
File Size	Small Medium Large User Select	<ul style="list-style-type: none"> ■ You can adjust the file size for the scanned data. ■ If you selected Color or Gray in Quality, select a file size for the scanned data from the drop-down list. ■ If you select User Select, you must select the setting from the machine's control panel.

Setting	Options	Description
2-sided Scan	Off Long edge Short edge	When using 2-sided scanning, select Long edge or Short edge so the layout of the data file's pages matches your original.
Brightness	-50 -40 -30 -20 -10 0 +10 +20 +30 +40 +50	<p>Adjust the setting (-50 to 50) to get the best image. The default value of 0 represents an average and is suitable for most images. If the scanned image is too light, set a lower Brightness level and scan the document again.</p> <p>If the image is too dark, set a higher Brightness level and scan the document again.</p>
Contrast	-50 -40 -30 -20 -10 0 +10 +20 +30 +40 +50	<p>Adjust the setting (-50 to 50) to get the best image. The default value of 0 represents an average and is suitable for most images.</p> <p>An increase emphasizes dark and light areas of the image, while a decrease reveals more details in gray areas.</p>

- 14 In the **Margin Settings**, enter -3 to 3 to add or remove a specific margin at the edge of the image.
- 15 Set **Auto Deskew**¹ to **Auto** to correct the skew (less than 0.36 in. (9 mm) from the center of the document to the edge) of the scanned data.
- 16 Set **Skip Blank Page**¹ to **On** to remove blank pages of the document from the scanned data.
- 17 Select -5 to 5 from the drop-down list to adjust the **Skip Blank Page sensitivity**.
- 18 Select **Continuous Scan** to **On** to continue scanning.
- 19 Set the **Passive Mode** option to off or on depending on your FTP server and network firewall configuration. The default setting is **On**. In most cases this setting does not need to be changed.
- 20 Change the **Port Number** setting used to access the FTP server. The default for this setting is port 21. In most cases this setting does not need to be changed.
- 21 Click **Submit**.

¹ Depending upon the condition of the original document, this function may not work properly.

NOTE



Using the following characters: ?, /, \, ", :, <, >, | or * may cause a sending error.

Scan Using FTP Server Profiles

NOTE

- If you have set up the machine using the USB interface method, you must set up the machine using the wireless (ADS-2800W / ADS-3600W) with the installation DVD-ROM (see the *Quick Setup Guide*) to use the Scan to FTP feature.
 - Before starting Scan to FTP, you must configure the Scan to FTP profile (see *Scan Documents to an FTP Server* on page 164).
-

(ADS-2400N / ADS-3000N)

- 1 Load your document.
- 2 Press ,  or  to which you have assigned the Scan to FTP feature. The machine starts scanning.
To assign the scan feature to the Network Device key, see *Assign the Scan Feature to the Network Device Key 1-3* on page 31.

(ADS-2800W / ADS-3600W)

- 1 Load your document.
- 2 Press ◀ or ▶ to display to FTP/SFTP.
- 3 Press to FTP/SFTP.
- 4 Press ▲ or ▼ to choose one of the FTP server profiles listed.
Do one of the following:
 - If the Scan to FTP profile is complete, go to 7.
 - If the Scan to FTP profile is not complete, go to 5.
- 5 Press Options.
- 6 Configure the following settings as needed. To configure more detailed settings, press Advanced Settings. For more information, see page 227. Press OK.
 - 2-sided Scan
 - Scan Type
 - Resolution
 - File Type
 - Document Size
 - File Name
 - File Name Style

Scan Using the Control Panel

- File Size
- Auto Deskew
- Skip Blank Page
- User Name
- Advanced Settings

NOTE

To save the profile as a shortcut, press **Save as Shortcut**.

- 7 Press **Start**.
The Touchscreen displays **Connecting**. When the connection to the FTP server is successful the machine starts the scanning process.

Scan Documents to an SFTP Server

When you choose Scan to SFTP, you can scan a black and white or color document directly to an SFTP server on your local network, or on the Internet.

The details required to use Scan to SFTP can be entered by using Web Based Management to pre-configure and store the details in an SFTP Profile.

NOTE

- Scan to SFTP is available when SFTP profiles are configured by using Web Based Management.
- We recommend Microsoft® Internet Explorer® 8/10/11 for Windows® and Safari 8.0 for Macintosh. Also make sure that JavaScript and Cookies are always enabled in whichever browser you use. If a different web browser is used, make sure it is compatible with HTTP 1.0 and HTTP 1.1.

Start Web Based Management

NOTE

If you have set up the machine using the USB interface method, you must set up the machine using the wireless network method with the installation DVD-ROM (see the *Quick Setup Guide*) to use Web Based Management.

(ADS-2400N / ADS-3000N)

- 1 Start the ControlCenter application.
 - Windows®
 - a Click the  (ControlCenter4) icon in the task tray and then select **Open** from the menu. The **ControlCenter4** window appears.

- b Click the **Device Settings** tab (the example below uses **Home Mode**).

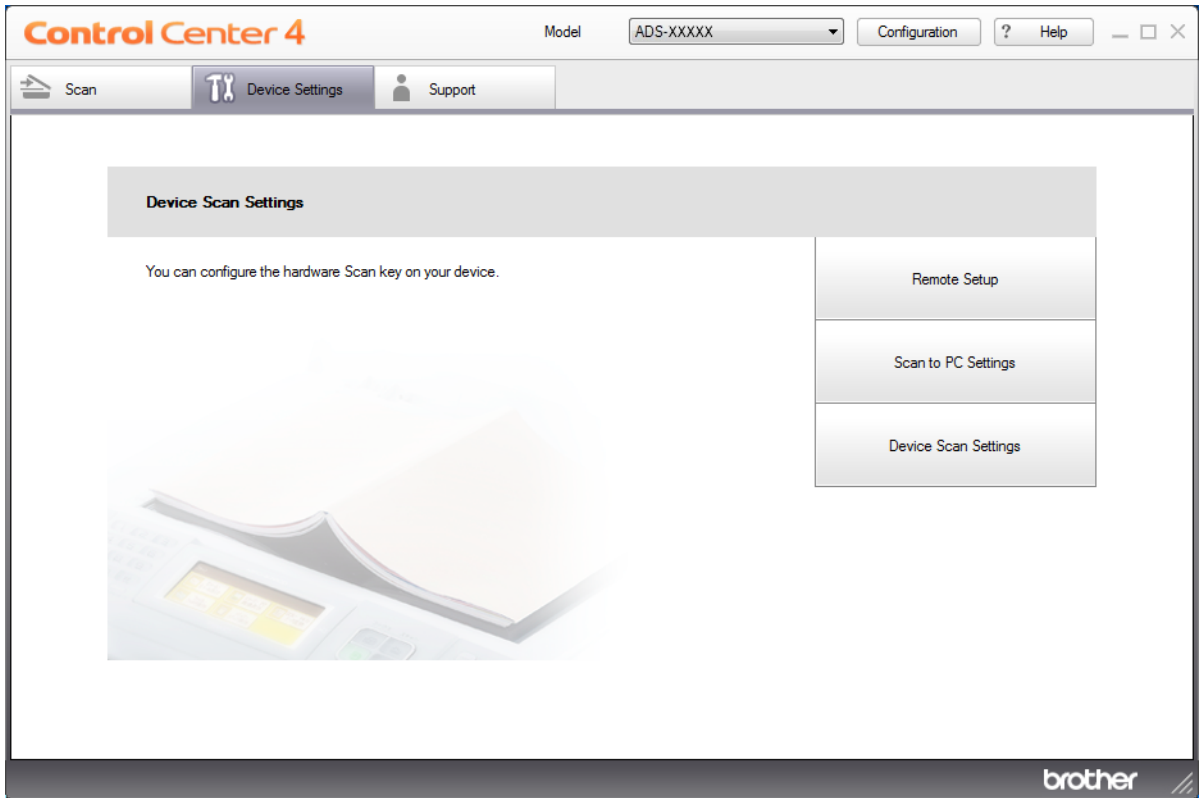

NOTE

If using **Advanced Mode**, click the  (Settings) icon to access **Device Settings**.



■ Macintosh

- a Click the  (ControlCenter2) icon in the Dock. The **ControlCenter2** window appears.
- b Click the **DEVICE SETTINGS** tab.



- 2 Click the **Scan to Net Settings** button. The Web Based Management window appears. (ADS-2800W / ADS-3600W)

Start your web browser.

In your browser's address bar, type your machine's IP address (or your print server name). For example: <http://192.168.1.2>. You can use the machine's LCD to find its IP address. No password is required by default.

If you have previously set a password, type it, and then press .

Configure the SFTP Default Settings

- 1 Click the **Scan** tab.
- 2 Click the **Scan to FTP/SFTP/Network/SharePoint** menu in the left navigation bar.
- 3 Select the **SFTP** option, and then click **Submit**.
- 4 Click the **Scan to FTP/SFTP/Network/SharePoint Profile** menu in the left navigation bar.

The screenshot shows the Brother Solutions Center web interface. The top navigation bar includes tabs for General, Address Book, E-mail, Scan, Administrator, and Network. The left sidebar contains a navigation menu with options like Scan, Scan Job e-mail report, Scan File Name, Scan to USB, Scan to E-mail Server, Scan to FTP/SFTP/Network/SharePoint, and Scan from PC. The main content area is titled "Profile 1 (SFTP)" and contains the following configuration fields:

- Profile Name:** Text input field.
- Host Address:** Text input field.
- Username:** Text input field.
- Auth. Method:** Radio buttons for Password and Public Key (selected).
- Password:** Text input field.
- Retype password:** Text input field.
- Client Key Pair:** Dropdown menu (None selected).
- Server Public Key:** Dropdown menu (None selected).
- Store Directory:** Text input field.
- File Name:** Dropdown menu (BRN30055C25B261 selected).
- Quality:** Dropdown menu (Color 300 dpi selected).
- Auto Color detect adjust:** Checkmark.

- 5 Select the profile you want to set up or change.
- 6 In the **Profile Name** field, type a name for this server profile (up to 15 alphanumeric characters). This name will be displayed in **Destination** in **Scan to Network Device** from the **Scan** tab (ADS-2400N / ADS-3000N) or on the Touchscreen of the machine (ADS-2800W / ADS-3600W).
- 7 In the **Host Address** field, type the Host Address (for example: sftp.example.com; up to 64 characters) or the IP address (for example: 192.23.56.189), and type the path (up to 60 characters) to the folder on the FTP server where you want to send your scanned data. Do not type a slash mark at the beginning of the path.
- 8 In the **Username** field, type the user name (up to 32 characters), that has permission to write data to the SFTP server.
- 9 In the **Auth. Method** field, select **Password** or **Public Key**.
- 10 Do one of the following:
 - When you select **Password**, type the password (up to 32 characters) associated with the user name you typed in the **Username** field. Type the password again in the **Retype Password** field.
 - When you select **Public Key**, select the authentication type from the **Client Key Pair** dropdown list.

- 11 Select the authentication type from the **Server Public Key** drop-down list.
- 12 In the **Store Directory** field, enter the destination folder where your document will be stored on the FTP server (up to 60 characters).
- 13 Click the **File Name** drop-down list, and then select a file name prefix from the three preset names provided, or from fourteen user-defined names. The file name used for the scanned document will be the file name prefix you select, followed by the last six digits of the scanner counter and the file extension (for example: "Estimate_098765.pdf").
- 14 Choose the quality, file type, document size, file size, 2-sided scan, brightness and contrast you want to use for the scanned data. The following settings can be changed.

Setting	Options	Description
Quality	Color 100 dpi Color 150 dpi Color 200 dpi Color 300 dpi Color 600 dpi Color Auto Gray 100 dpi Gray 150 dpi Gray 200 dpi Gray 300 dpi Gray 600 dpi Gray Auto B&W 100 dpi B&W 150 dpi B&W 200 dpi B&W 300 dpi B&W 600 dpi B&W Auto Auto 100 dpi Auto 150 dpi Auto 200 dpi Auto 300 dpi Auto 600 dpi Auto User Select	<ul style="list-style-type: none"> ■ You can select a scanning quality from the Quality drop-down list. Higher qualities take more memory and transfer time, but produces a finer scanned image. ■ If you select User Select, you must select the setting from the control panel of the machine's control panel.

Setting	Options	Description
File Type	PDF Single-Page PDF Multi-Page JPEG PDF/A Single-Page PDF/A Multi-Page Secure PDF Single-Page Secure PDF Multi-Page Signed PDF Single-Page Signed PDF Multi-Page High Compression PDF Single-Page High Compression PDF Multi-Page XPS TIFF Single-Page TIFF Multi-Page User Select	<ul style="list-style-type: none"> ■ Select the file type you want to use for the scanned data. ■ If you select Secure PDF, the machine will ask you to enter a 4 digit password using numbers 0-9 before it starts scanning. ■ If you select Signed PDF, you must install a certificate to your machine using Web Based Management. Select Signed PDF from Administrator in Web Based Management. See the <i>Network User's Guide</i>. ■ PDF/A is a PDF file format intended for long-term archiving. This format contains all the necessary information to be able to reproduce the document after long-term storage. ■ Signed PDF helps prevent data tampering and the impersonation of an author by including a digital certificate within the document. ■ You can select PDF, Secure PDF, PDF/A, Signed PDF, JPEG or XPS when you select Color or Gray in Quality. ■ You can select PDF, Secure PDF, PDF/A, Signed PDF or TIFF when you select B&W in Quality. ■ You can select PDF, Secure PDF or Signed PDF when you select Auto in Quality. ■ If you select User Select, you must select the setting from the control panel of the machine. ■ If you select High Compression PDF, select only Color 300dpi or Gray 300dpi.
Document Size	Auto A4 Letter Legal B5 A5 B6 A6 Business Card Long Paper User Select	<ul style="list-style-type: none"> ■ If you select Auto, you can scan documents of any size without making adjustments to Document Size. For faster scan speeds, select the exact size of your document from the Document Size drop-down list. ■ If you select 600 dpi for Quality, you cannot select Auto. ■ When Auto Deskew is set to Off, you can select A4, Letter, Legal, B5, A5, B6, A6, Business Card or Long Paper (when Auto XXX dpi is not selected as the Quality). ■ You can select Long Paper when you choose the following settings: <ul style="list-style-type: none"> • Quality: other than Auto • Auto Deskew: Off • Skip Blank Page: Off
File Size	Small Medium Large User Select	<ul style="list-style-type: none"> ■ You can adjust the file size for the scanned data. ■ If you selected Color or Gray in Quality, select a file size for the scanned data from the drop-down list. ■ If you select User Select, you must select the setting from the control panel of the machine.

Setting	Options	Description
2-sided Scan	Off Long edge Short edge	To scan both sides of the document, select Long edge or Short edge depending on the layout of your original to make sure that the data file created appears correctly in the scanned document.
Brightness	-50 -40 -30 -20 -10 0 +10 +20 +30 +40 +50	<p>Adjust the setting (-50 to 50) to get the best image. The default value of 0 represents an average and is suitable for most images. If the scanned image is too light, set a lower Brightness level and scan the document again.</p> <p>If the image is too dark, set a higher Brightness level and scan the document again.</p>
Contrast	-50 -40 -30 -20 -10 0 +10 +20 +30 +40 +50	<p>Adjust the setting (-50 to 50) to get the best image. The default value of 0 represents an average and is suitable for most images.</p> <p>An increase emphasizes dark and light areas of the image, while a decrease reveals more details in gray areas.</p>

- 15 Select **Color** or **Black and White/Gray** to adjust the detection level.
- 16 In the **Margin Settings**, enter -3 to 3 to add or remove a specific margin at the edge of the image.
- 17 Set **Auto Deskew**¹ to **Auto** to correct the skew (less than 0.36 in. (9 mm) from the center of the document to the edge) of the scanned data.
- 18 Set **Skip Blank Page**¹ to **On** to remove blank pages of the document from the scanned data.
- 19 Select -5 to 5 from the drop-down list to adjust the **Skip Blank Page sensitivity**.
- 20 Select **Continuous Scan** to **On** to continue scanning.
- 21 Change the **Port Number** setting used to access the FTP server. The default for this setting is port 21. In most cases this setting does not need to be changed.
- 22 Click **Submit**.

¹ Depending upon the condition of the original document, this function may not work properly.

NOTE



Using the following characters: ?, /, \, ", :, <, >, | or * may cause a sending error.

Scan Using SFTP Server Profiles

NOTE

- If you have set up the machine using the USB interface method, you must set up the machine using the wireless network method with the installation DVD-ROM (see the *Quick Setup Guide*) to use the Scan to SFTP feature.
- Before starting Scan to SFTP, you must configure the Scan to SFTP profile (see *Scan Documents to an SFTP Server* on page 174).

(ADS-2400N / ADS-3000N)

- 1 Load your document.
- 2 Press ,  or  to which you have assigned the Scan to SFTP feature. The machine starts scanning.
To assign the scan feature to the Network Device key, see *Assign the Scan Feature to the Network Device Key 1-3* on page 31.

(ADS-2800W / ADS-3600W)

- 1 Load your document.
- 2 Press ◀ or ▶ to display to FTP/SFTP.
- 3 Press to FTP/SFTP.
- 4 Press ▲ or ▼ to choose one of the SFTP server profiles listed.
Do one of the following:
 - If the Scan to SFTP profile is complete, go to 7.
 - If the Scan to SFTP profile is not complete, go to 5.
- 5 Press Options.
- 6 Configure the following settings as needed. To configure more detailed settings, press Advanced Settings. For details, see page 227. Press OK.
 - 2-sided Scan
 - Scan Type
 - Resolution
 - File Type
 - Document Size
 - File Name
 - File Name Style

Scan Using the Control Panel

- File Size
- Auto Deskew
- Skip Blank Page
- User Name
- Advanced Settings

NOTE

To save the profile as a shortcut, press **Save as Shortcut**.

- 7 Press **Start**.
The Touchscreen displays **Connecting**. When the connection to the SFTP server is successful the machine starts the scanning process.

Scan Documents to a Shared Folder / Network Location (Windows®)

When you choose Scan to Network, you can scan documents directly to a shared folder located on your local network or the Internet.

The details required to use Scan to Network can be entered by using Web Based Management to preconfigure and store the details in a Scan to Network profile. The Scan to Network profile stores user information and configuration settings for use on a network, or the Internet.

NOTE

- Scan to Network is available when Scan to Network profiles are configured by using Web Based Management.
- You must configure the SNTP protocol (network time server), or set the date, time, and time zone correctly for authentication. For more information, see the *Network User's Guide*.
- We recommend Microsoft® Internet Explorer® 8/10/11. Also make sure that JavaScript and Cookies are always enabled in whichever browser you use. If a different web browser is used, make sure it is compatible with HTTP 1.0 and HTTP 1.1.

Start Web Based Management

NOTE

To use Web Based Management you must set up the machine using the wireless (ADS-2800W / ADS-3600W) network method with the installation DVD-ROM (see the *Quick Setup Guide*).

(ADS-2400N / ADS-3000N)

- 1 Start the ControlCenter application.
 - Windows®
 - a Click the  (ControlCenter4) icon in the task tray and then select **Open** from the menu. The **ControlCenter4** window appears.

- b Click the **Device Settings** tab (the example below uses **Home Mode**).

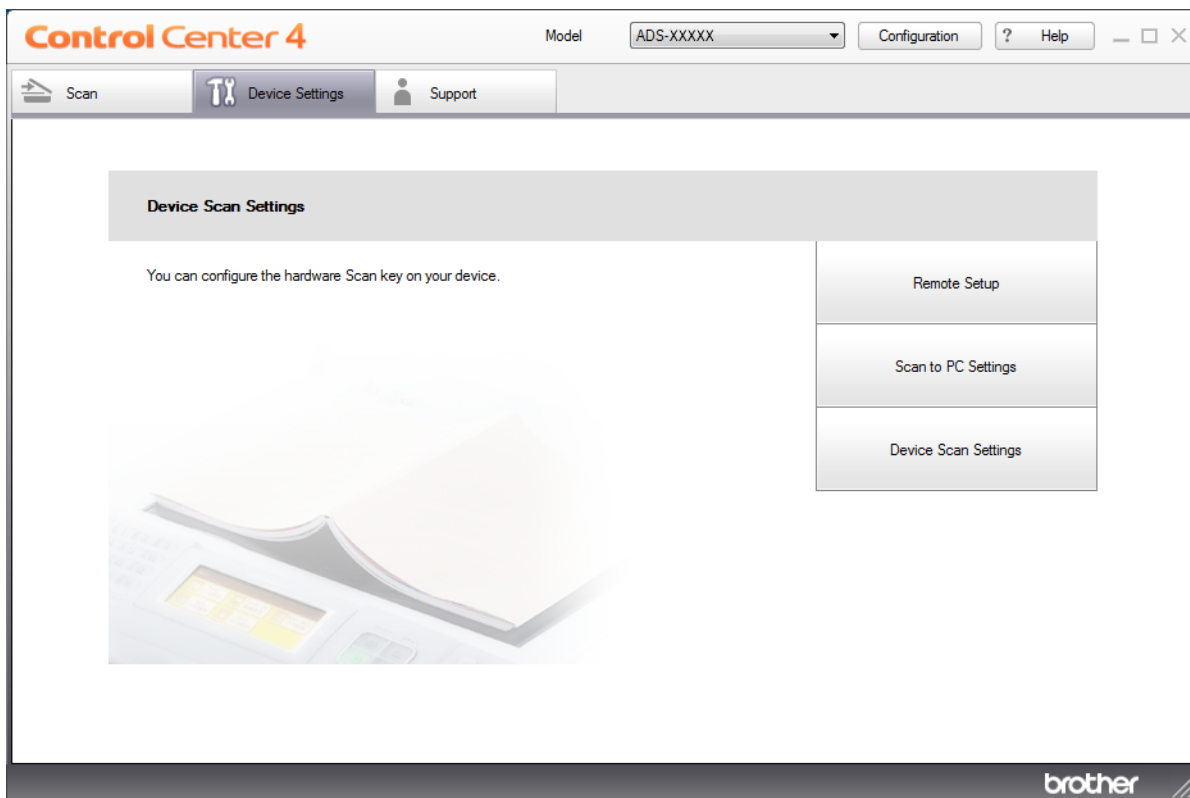

NOTE

If using **Advanced Mode**, click the  (Settings) icon to access **Device Settings**.



■ Macintosh

- a Click the  (ControlCenter2) icon in the Dock. The **ControlCenter2** window appears.
- b Click the **DEVICE SETTINGS** tab.

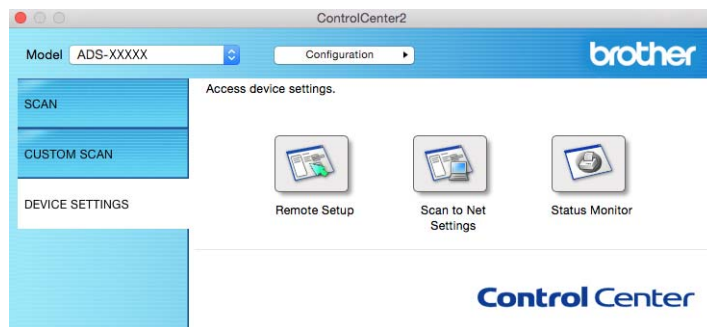

- 2 Click the **Scan to Net Settings** button. The Web Based Management window appears.

(ADS-2800W / ADS-3600W)

Start your web browser.

In your browser's address bar, type your machine's IP address (or your print server name). For example: <http://192.168.1.2>. You can use the machine's LCD to find its IP address. No password is required by default.

If you have previously set a password, type it, and then press .

Configure the Scan to Network Default Settings

- 1 Click the **Scan** tab.
- 2 Click the **Scan to FTP/SFTP/Network/SharePoint**, menu in the left navigation bar.
- 3 Select the **Network** option, and then click **Submit**.
- 4 Click the **Scan to FTP/SFTP/Network/SharePoint Profile** menu in the left navigation bar.

The screenshot shows the 'Profile 1 (Network)' configuration page in the Brother Solutions Center. The left navigation menu is expanded to show 'Scan to FTP/SFTP/Network/SharePoint Profile'. The main content area contains the following settings:

- Profile Name:** [Empty text field]
- Network Folder Path:** (Example: \\ComputerName\SharedFolder) [Text field]
- File Name:** BRN30055C25B261 [Dropdown menu]
- Quality:** Color 300 dpi [Dropdown menu]
- Auto Color detect adjust:**
 - Color: [Dropdown menu]
 - Black and White/Gray: [Dropdown menu]
- File Type:** PDF Multi-Page [Dropdown menu]
- Document Size:** Letter [Dropdown menu]
- Margin Settings:**
 - Top: 0.0 mm (-3.0 - 3.0)
 - Left: 0.0 mm (-3.0 - 3.0)
 - Right: 0.0 mm (-3.0 - 3.0)

- 5 Select the profile you want to set up or change.
- 6 In the **Profile Name** field, type a name for this server profile (up to 15 alphanumeric characters). This name will be displayed in **Destination in Scan to Network Device** from the **Scan** tab (ADS-2400N / ADS-3000N) or on the Touchscreen of the machine (ADS-2800W / ADS-3600W).
- 7 The **Network Folder Path** is the destination address (for example \\ComputerName\SharedFolder) (up to 255 characters).
- 8 Click the **File Name** drop-down list, and then select a file name prefix from the three preset names provided, or from fourteen user-defined names. The file name used for the scanned document will be the file name prefix you select, followed by the last six digits of the scanner counter and the file extension (for example: "Estimate_098765.pdf").
- 9 In the **Margin Settings**, enter -3 to 3 to add or remove a specific margin at the edge of the image.

- 10 Choose the quality, file type, document size, file size, 2-sided scan, brightness and contrast you want to use for the scanned data. The following settings can be changed.

Setting	Options	Description
Quality	Color 100 dpi Color 150 dpi Color 200 dpi Color 300 dpi Color 600 dpi Color Auto Gray 100 dpi Gray 150 dpi Gray 200 dpi Gray 300 dpi Gray 600 dpi Gray Auto B&W 100 dpi B&W 150 dpi B&W 200 dpi B&W 300 dpi B&W 600 dpi B&W Auto Auto 100 dpi Auto 150 dpi Auto 200 dpi Auto 300 dpi Auto 600 dpi Auto User Select	<ul style="list-style-type: none"> ■ You can select a scanning quality from the Quality drop-down list. Higher qualities take more memory and transfer time, but produce a finer scanned image. ■ If you select User Select, you must select the setting from the control panel of the machine.

Setting	Options	Description
File Type	PDF Single-Page PDF Multi-Page JPEG PDF/A Single-Page PDF/A Multi-Page Secure PDF Single-Page Secure PDF Multi-Page Signed PDF Single-Page Signed PDF Multi-Page High Compression PDF Single-Page High Compression PDF Multi-Page XPS TIFF Single-Page TIFF Multi-Page User Select	<ul style="list-style-type: none"> ■ Select the file type you want to use for the scanned data. ■ If you select Secure PDF, the machine will ask you to enter a 4 digit password using numbers 0-9 before it starts scanning. ■ If you select Signed PDF, you must install a certificate to your machine using Web Based Management. Select Signed PDF from Administrator in Web Based Management. See the <i>Network User's Guide</i>. ■ PDF/A is a PDF file format intended for long-term archiving. This format contains all the necessary information to be able to reproduce the document after long-term storage. ■ Signed PDF helps prevent data tampering and the impersonation of an author by including a digital certificate within the document. ■ You can select PDF, Secure PDF, PDF/A, Signed PDF, JPEG or XPS when you select Color or Gray in Quality. ■ You can select PDF, Secure PDF, PDF/A, Signed PDF or TIFF when you select B&W in Quality. ■ You can select PDF, Secure PDF or Signed PDF when you select Auto in Quality. ■ If you select User Select, you must select the setting from the control panel of the machine. ■ If you select High Compression PDF, you can select only Color 300dpi or Gray 300dpi.
Document Size	Auto A4 Letter Legal B5 A5 B6 A6 Business Card Long Paper User Select	<ul style="list-style-type: none"> ■ If you select Auto, you can scan documents of any size without making adjustments to Document Size. For faster scan speeds, select the exact size of your document from the Document Size drop-down list. ■ If you select 600 dpi for Quality, you cannot select Auto. ■ When Auto Deskew is set to Off, you can select A4, Letter, Legal, B5, A5, B6, A6, Business Card or Long Paper (when Auto XXX dpi is not selected as the Quality). ■ You can select Long Paper when you choose the following settings: <ul style="list-style-type: none"> • Quality: other than Auto • Auto Deskew: Off • Skip Blank Page: Off
File Size	Small Medium Large User Select	<ul style="list-style-type: none"> ■ You can adjust the file size for the scanned data. ■ If you selected Color or Gray in Quality, select the file size for the scanned data from the drop-down list. ■ If you select User Select, you must select the setting from the control panel of the machine.



Setting	Options	Description
2-sided Scan	Off Long edge Short edge	To scan both sides of the document, select Long edge or Short edge depending on the layout of your original to make sure that the data file created appears correctly in the scanned document.
Brightness	-50 -40 -30 -20 -10 0 +10 +20 +30 +40 +50	<p>Adjust the setting (-50 to 50) to get the best image. The default value of 0 represents an average and is suitable for most images. If the scanned image is too light, set a lower Brightness level and scan the document again.</p> <p>If the image is too dark, set a higher Brightness level and scan the document again.</p>
Contrast	-50 -40 -30 -20 -10 0 +10 +20 +30 +40 +50	<p>Adjust the setting (-50 to 50) to get the best image. The default value of 0 represents an average and is suitable for most images.</p> <p>An increase emphasizes dark and light areas of the image, while a decrease reveals more details in gray areas.</p>

- 11 Select **Color** or **Black and White/Gray** to adjust the detection level.
- 12 Set **Auto Deskew**¹ to **Auto** to correct the skew (less than 0.36 in. (9 mm) from the center of the document to the edge) of the scanned data.
- 13 Set **Skip Blank Page**¹ to **On** to remove blank pages of the document from the scanned data.
- 14 Select -5 to 5 from the drop-down list to adjust the **Skip Blank Page sensitivity**.
- 15 Select **Continuous Scan** to **On** to continue scanning.
- 16 To protect the profile, choose **On** from **Use PIN for Authentication** and enter a 4-digit PIN number in **PIN Code**.
- 17 Select the authentication method. Choose **Auto**, **Kerberos** or **NTLMv2**. If you choose **Auto**, the authentication method will be detected automatically.
- 18 Enter the **Username** that has been registered with the CIFS server for the machine (up to 96 characters).
- 19 Enter the **Password** for access to the CIFS server (up to 32 characters).
- 20 Click **Submit**.
- 21 Select **Date&Time** from the **General** tab.
- 22 Enter the date and time used on the CIFS server.
- 23 Select the time zone from the drop-down list.
- 24 Click **Submit**.

¹ Depending upon the condition of the original document, this function may not work properly.

Scan Using Scan to Network Profiles

(ADS-2400N / ADS-3000N)

- 1 Load your document.
- 2 Press ,  or  to which you have assigned the Network Scan feature.
The machine starts scanning.

(ADS-2800W / ADS-3600W)

- 1 Load your document.
- 2 Swipe left or right, or press ◀ or ▶ to display Scan 1.
- 3 Press to Network.
- 4 Press ▲ or ▼ to choose one of Network server profiles listed.
If the Touchscreen prompts you to enter a PIN number, enter the 4-digit PIN number for the profile on the Touchscreen.
Press OK.
Do one of the following:
 - If the Scan to Network profile is complete, go to 7.
 - If the Scan to Network profile is not complete, go to 5.
- 5 Press Options.
- 6 Configure the following settings as needed. To configure more detailed settings, press Advanced Settings. For more information, see page 227. Press OK.
 - 2-sided Scan
 - Scan Type
 - Resolution
 - File Type
 - Document Size
 - File Name
 - File Name Style
 - File Size
 - Auto Deskew
 - Skip Blank Page
 - User Name
 - Advanced Settings

NOTE

- If you choose *Secure PDF for File Type*, the machine will ask you to enter a 4 digit password using numbers 0-9 before it starts scanning.
 - If you choose *Signed PDF for File Type*, you must install and then configure a certificate to your machine using *Web Based Management*.
 - To save the settings as a shortcut, press *Save as Shortcut*.
-

- 7 Press *Start*.
The Touchscreen displays *Connecting*. When the connection to the Network is successful the machine starts the scanning process.

Scan Documents to SharePoint

When you choose Scan to SharePoint, you can scan a black and white or color document directly to an SharePoint server.

Use Web Based Management to pre-configure and store the details in a SharePoint Profile.

NOTE

- Scan to SharePoint is available when Web Based Management is used to configure SharePoint profiles.
- We recommend Microsoft® Internet Explorer® 8/10/11 for Windows® and Safari 8.0 for Macintosh. Also make sure that JavaScript and Cookies are always enabled in whichever browser you use. If a different web browser is used, make sure it is compatible with HTTP 1.0 and HTTP 1.1.

Start Web Based Management

NOTE

To use Web Based Management you must set up the machine using the wireless network method with the installation DVD-ROM (see the *Quick Setup Guide*).

(ADS-2400N / ADS-3000N)

1 Start the ControlCenter application.

■ Windows®

- a Click the  (ControlCenter4) icon in the task tray and then select **Open** from the menu. The **ControlCenter4** window appears.

b Click the **Device Settings** tab (the example below uses **Home Mode**).

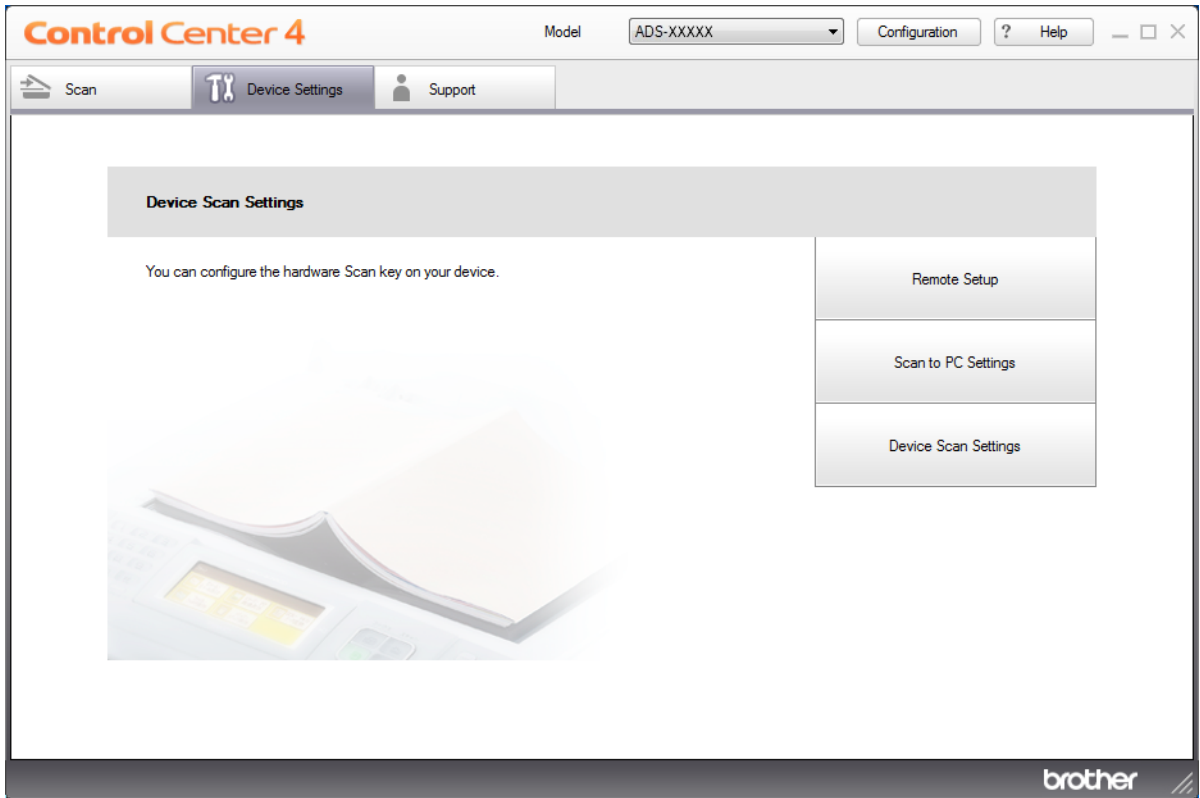

NOTE

If using **Advanced Mode**, click the  (Settings) icon to access **Device Settings**.



■ Macintosh

- a Click the  (ControlCenter2) icon in the Dock. The **ControlCenter2** window appears.
- b Click the **DEVICE SETTINGS** tab.



- 2 Click the **Scan to Net Settings** button. The Web Based Management window appears.

(ADS-2800W / ADS-3600W)

Start your web browser.

In your browser's address bar, type your machine's IP address (or your print server name). For example: <http://192.168.1.2>. You can use the machine's LCD to find its IP address. No password is required by default. If you have previously set a password, type it, and then press .

Set Up a Scan to SharePoint Profile

- 1 Click the **Scan** tab.
- 2 Click the **Scan to FTP/SFTP/Network/SharePoint** menu in the left navigation bar.
- 3 Select the **SharePoint** option, and then click **Submit**.
- 4 Click the **Scan to FTP/SFTP/Network/SharePoint Profile** menu in the left navigation bar.

- 5 Select the profile you want to set up or change.
- 6 In the **Profile Name** field, type a name for this server profile (up to 15 alphanumeric characters). This name will be displayed in **Destination** in **Scan to Network Device** from the **Scan** tab (ADS-2400N / ADS-3000N) or on the Touchscreen of the machine (ADS-2800W / ADS-3600W).
- 7 In the **SharePoint Site Address** field, copy and paste the full destination address. (for example: ftp.example.com; up to 64 characters) or the IP address (for example: 192.23.56.189).
- 8 Click the **File Name** drop-down list, and then select a file name prefix from the three preset names provided, or from fourteen user-defined names. The file name used for the scanned document will be the file name prefix you select, followed by the last six digits of the ADF scanner counter and the file extension (for example: "Estimate_098765.pdf").
- 9 Select the Color or Black and White/Gray to adjust the detection level.

- 10 Choose the quality, file type, document size and 2-sided Scan you want to use for the scanned data. The following settings can be changed.

Setting	Options	Description
Quality	Color 100 dpi Color 150 dpi Color 200 dpi Color 300 dpi Color 600 dpi Color Auto Gray 100 dpi Gray 150 dpi Gray 200 dpi Gray 300 dpi Gray 600 dpi Gray Auto B&W 100 dpi B&W 150 dpi B&W 200 dpi B&W 300 dpi B&W 600 dpi B&W Auto Auto 100 dpi Auto 150 dpi Auto 200 dpi Auto 300 dpi Auto 600 dpi Auto User Select	<ul style="list-style-type: none"> ■ Select a scanning quality from the Quality drop-down list. Higher qualities take more memory and transfer time, but produce a finer scanned image. ■ If you select User Select, you must select the setting from the control panel of the machine.

Setting	Options	Description
File Type	PDF Single-Page PDF Multi-Page JPEG PDF/A Single-Page PDF/A Multi-Page Secure PDF Single-Page Secure PDF Multi-Page Signed PDF Single-Page Signed PDF Multi-Page High Compression PDF Single-Page High Compression PDF Multi-Page XPS TIFF Single-Page TIFF Multi-Page User Select	<ul style="list-style-type: none"> ■ Select the file type you want to use for the scanned data. ■ If you select Secure PDF, the machine will ask you to enter a 4 digit password using numbers 0-9 before it starts scanning. ■ If you select Signed PDF, you must install a certificate to your machine using Web Based Management. Select Signed PDF from Administrator in Web Based Management. See the <i>Network User's Guide</i>. ■ PDF/A is a PDF file format intended for long-term archiving. This format contains all the necessary information to be able to reproduce the document after long-term storage. ■ Signed PDF helps prevent data tampering and the impersonation of an author by including a digital certificate within the document. ■ You can select PDF, Secure PDF, PDF/A, Signed PDF, JPEG or XPS when you select Color or Gray in Quality. ■ You can select PDF, Secure PDF, PDF/A, Signed PDF or TIFF when you select B&W in Quality. ■ You can select PDF, Secure PDF or Signed PDF when you select Auto in Quality. ■ If you select User Select, you must select the setting from the control panel of the machine. ■ If you select High Compression PDF, you can select only Color 300dpi or Gray 300dpi.
Document Size	Auto A4 Letter Legal B5 A5 B6 A6 Business Card Long Paper User Select	<ul style="list-style-type: none"> ■ If you select Auto, you can scan documents of any size without making adjustments to Document Size. For faster scan speeds, you can select the exact size of your document from the Document Size drop-down list. ■ If you select 600 dpi for Quality, you cannot select Auto. ■ When Auto Deskew is set to Off, you can select A4, Letter, Legal, B5, A5, B6, A6, Business Card or Long Paper (when Auto XXX dpi is not selected as the Quality). ■ You can select Long Paper when you choose the following settings: <ul style="list-style-type: none"> • Quality: other than Auto • Auto Deskew: Off • Skip Blank Page: Off
File Size	Small Medium Large User Select	<ul style="list-style-type: none"> ■ You can adjust the file size for the scanned data. ■ If you selected Color or Gray in Quality, select a file size for the scanned data from the drop-down list. ■ If you select User Select, you must select the setting from the control panel of the machine.

Setting	Options	Description
2-sided Scan	Off Long edge Short edge	To scan both sides of the document, select Long edge or Short edge depending on the layout of your original to make sure that the data file created appears correctly in the scanned document.
Brightness	-50 -40 -30 -20 -10 0 +10 +20 +30 +40 +50	<p>Adjust the setting (-50 to 50) to get the best image. The default value of 0 represents an average and is suitable for most images. If the scanned image is too light, set a lower brightness level and scan the document again.</p> <p>If the image is too dark, set a higher brightness level and scan the document again.</p>
Contrast	-50 -40 -30 -20 -10 0 +10 +20 +30 +40 +50	<p>Adjust the setting (-50 to 50) to get the best image. The default value of 0 represents an average and is suitable for most images.</p> <p>An increase emphasizes dark and light areas of the image, while a decrease reveals more details in gray areas.</p>

- 11 In the **Margin Settings**, enter -3 to 3 to add or remove a specific margin at the edge of the image.
- 12 Set **Auto Deskew**¹ to **Auto** to correct the skew (less than 0.36 in. (9 mm) from the center of the document to the edge) of the scanned data.
- 13 Set **Skip Blank Page**¹ to **On** to remove blank pages of the document from the scanned data. You can adjust the sensitivity to detect various levels of blank pages.
- 14 Select -5 to 5 from the drop-down list to adjust the **Skip Blank Page sensitivity**.
- 15 Select **Continuous Scan** to **On** to continue scanning.
- 16 To PIN-protect this profile, in the **Use PIN for Authentication** field, select **On**.
- 17 If you selected **On** for **Use PIN for Authentication** field, in the **PIN Code** field, type a four-digit PIN.
- 18 To set your authentication method, select **Auto**, **Kerberos**, **NLMv2**, or **Basic** from the **Auth. Method** menu. If you choose **Auto**, the authentication method will be detected automatically.
- 19 In the **Username** field, type the user name (up to 96 characters) that has permission to write data to the folder specified in the **Sharepoint Site Address** field. If the user name is part of a domain, enter the user name in one of the following styles:
user@domain
domain\user
- 20 In the **Password** field, type the password (up to 32 characters) associated with the user name you entered in the **Username** field. Type the password again in the **Retype Password** field.
- 21 To set the Kerberos Server Address manually, in the **Kerberos Server Address** field, type the Kerberos Server Address (for example: kerberos.example.com; up to 64 characters).
- 22 Click **Submit**.

¹ Depending upon the condition of the original document, this function may not work properly.

NOTE

Using the following characters: ?, /, \, ", :, <, >, | or * may cause a sending error.



Scan Using Web Services (Windows Vista® SP2 or Later, Windows® 7, Windows® 8 and Windows® 8.1)

The menu that allows you to use Web Services for scanning is displayed in **Destination** field when you click **Scan to Network Device** in the left navigation bar (ADS-2400N / ADS-3000N) or on the Touchscreen of the machine (ADS-2800W / ADS-3600W), if you have installed the driver for scanning via Web Services. For information about installing Web Services, see *Install Drivers Used for Scanning via Web Services (Windows Vista®, Windows® 7, Windows® 8, Windows® 8.1)* in the *Network User's Guide*.

- If the Touchscreen or LED indications show Out of Memory, decrease the **Paper size** setting or the **Resolution** setting. For more information, see *Configuring Settings for Scanning* on page 203.
- Certain characters in the messages displayed on the Touchscreen may be replaced with spaces when the language settings of your OS and your Brother machine are different.

(ADS-2400N / ADS-3000N)

If you are using ADS-2400N or ADS-3000N, you must assign WS Scan to a Network Device Key 1 - 3. For more information, see *Assign the Scan Feature to the Network Device Key 1-3* on page 31.



- 1 Load your document.
- 2 Press ,  or  to which you have assigned the Web Service Scan feature.
The machine starts scanning.

(ADS-2800W / ADS-3600W)

- 1 Load your document.
- 2 Swipe left or right, or press ◀ or ▶ to display Scan 3.
- 3 Press WS Scan and then OK.
- 4 Press the type of scan you want to do.
- 5 Press ▲ or ▼ to display the destination computer you want to send to.
Press the destination computer.
- 6 Press Start.
The machine starts scanning process.

Configuring Settings for Scanning

If the Touchscreen or LED indications show Out of Memory, decrease the **Paper size** setting or the **Resolution** setting.

- 1 Open the device settings for your operating system:
 - Windows Vista®
 **(Start) > Control Panel > Hardware and Sound > Scanners and Cameras.**
 - Windows® 7
 **(Start) > Control Panel > Hardware and Sound > Devices and Printers.**
 - Windows® 8 and Windows® 8.1
Move your mouse to the lower right corner of your desktop. When the menu bar appears, click **Settings**, and then click **Control Panel**. In the **Hardware and Sound** group, click **View devices and printers**.
- 2 Click your machine, and then click the **Scan profiles** button.
The **Scan profiles** dialog box appears.
- 3 Choose the scan profile you want to use. Make sure the scanner selected in **Scanner** is a Brother machine that supports Web Services for scanning.
Click **Set as Default**.
- 4 Click **Edit**. The **Edit Default Profile** dialog box appears.
- 5 Choose the **Source**, **Paper size**, **Color format**, **File type**, **Resolution**, **Brightness** and **Contrast** settings.
- 6 Click **Save Profile**. The settings will be applied when scanning using the Web Services protocol.

NOTE

If you are requested to choose a software application to scan, choose Windows® Fax and Scan or Windows® Photo Gallery from the list.

Send Scanned Documents Directly to an Email Address (ADS-2800W / ADS-3600W)

- 1 Load your document.
- 2 Swipe left or right, or press ◀ or ▶ to display Scan 2.
- 3 Press to E-mail Server.
- 4 Select the email address you want to send to by doing one of the following:
 - To select an email address from the Address Book, see *Select an Email Address from the Address Book* on page 205.
 - To enter an email address manually, see *Enter an Email Address Manually* on page 206.

NOTE

You can select up to 300 email addresses from the Address Book and enter up to 50 email addresses manually. The scanned data will be sent to all of the addresses at the same time.

- 5 Press OK and then do one of the following:
 - To use the default settings, go to 8.
 - To change the default settings, go to 6.
- 6 Press Options.
- 7 Configure the following settings as needed. To configure more detailed settings, press Advanced Settings. For more information, see page 227. Press OK.
 - 2-sided Scan
 - Scan Type
 - Resolution
 - File Type
 - Document Size
 - File Name
 - File Name Style
 - File Size
 - Auto Deskew
 - Skip Blank Page
 - Advanced Settings

NOTE

- To save the settings as a new default, press Set New Default.
- To restore all settings to the factory settings, press Factory Reset.

- 8 Press **Start**.
The machine starts scanning and then sends the scanned document to the email address directly.

NOTE

To save the settings as a shortcut, press **Save as Shortcut**. For more information, see *Shortcut Settings (ADS-2800W / ADS-3600W)* on page 12.

Select an Email Address from the Address Book

- 1 Swipe left or right, or press ◀ or ▶ to display **Scan 2**.
- 2 Press **to E-mail Server**.
- 3 Press **Address Book**.
- 4 Press . The software keyboard appears on the Touchscreen.

NOTE

- The LDAP protocol supports you to search for email addresses on your server. For information on how to configure LDAP protocol, see *Changing LDAP Configuration* in the *Network User's Guide*.
- The LDAP search result will be shown on the Touchscreen with  before the local address book search result.

- 5 Enter the initial characters for your search and then press **OK**. The machine starts searching the Address Book, and then the search result will be shown.
- 6 Swipe left or right, or press ▲ or ▼ until you find the name you are looking for.
- 7 Press the name from the result.
- 8 Press **Apply**.

NOTE

- To register an email address in the Address Book, see *Set Up the Address Book (ADS-2800W / ADS-3600W)* on page 207.
- You can select up to 300 email addresses from the Address Book and enter up to 50 email addresses manually. The scanned data will be sent to all of the addresses at the same time.

Enter an Email Address Manually

- 1 Swipe left or right, or press ◀ or ▶ to display Scan 2.
- 2 Press to E-mail Server.
- 3 Press Manual. The software keyboard appears on the Touchscreen.
- 4 Enter an email address and then press OK.
- 5 Press OK.

NOTE

You can enter up to 50 email addresses manually. The scanned data will be sent to all of the addresses at the same time.

Set Up the Address Book (ADS-2800W / ADS-3600W)

The Address Book feature lets you select an email address to send the scanned data directly. You can configure the Address Book from the control panel of the machine.

NOTE

You can also configure the Address Book with Remote Setup or Web Based Management.

Register an Email Address

You can register up to 300 email addresses and enter a name for each address.

- 1 Swipe left or right, or press ◀ or ▶ to display Scan 2.
- 2 Press to E-mail Server.
- 3 Press Address Book.
- 4 Press Edit.
- 5 Press Add New Address.
- 6 Press Name.
- 7 Enter a name and then press OK.
- 8 Press Address.
- 9 Enter an email address and then press OK.
- 10 Press OK.

Change an Email Address

- 1 Swipe left or right, or press ◀ or ▶ to display Scan 2.
- 2 Press to E-mail Server.
- 3 Press Address Book.
- 4 Press Edit.
- 5 Press Change.
- 6 Press ▲ or ▼ until you find the email address you want to change.
- 7 Press the email address. If the email address is used in one or more shortcuts, the Touchscreen displays that the address in the shortcut(s) will also change.
- 8 Press OK.

- 9 Do one of the following:
 - To change the name, go to step 10.
 - To change the email address, go to step 12.
- 10 Press **Name**. The software keyboard appears on the Touchscreen.
- 11 Enter a new name and then press **OK**. Go to step 14.
- 12 Press **Address**. The software keyboard appears on the Touchscreen.
- 13 Enter a new email address and then press **OK**.
- 14 Press **OK**.

NOTE

The Touchscreen displays a list of shortcuts using the email address you changed. The shortcut settings will automatically change.

Delete an Email Address

- 1 Swipe left or right, or press ◀ or ▶ to display **Scan 2**.
- 2 Press **to E-mail Server**.
- 3 Press **Address Book**.
- 4 Press **Edit**.
- 5 Press **Delete**.
- 6 Press ▲ or ▼ until you find the email address you want to delete.
- 7 Press the email address.
Press **OK**.
- 8 Press **Yes**.

NOTE

You cannot delete an email address used in a shortcut. Delete the shortcut first (see *Deleting Shortcuts* on page 17).

Set Up a Group

You can register up to 20 groups. Each group can have up to 299 email addresses.

NOTE

Before setting up a group, you must register more than one email address.

- 1 Swipe left or right, or press ◀ or ▶ to display `Scan 2`.
- 2 Press `to E-mail Server`.
- 3 Press `Address Book`.
- 4 Press `Edit`.
- 5 Press `Setup Groups`.
- 6 Press `Name`.
- 7 Enter a group name and then press `OK`.
- 8 Press `Add/Delete`.
- 9 Press ▲ or ▼ until you find the email address you want to add to the group.
- 10 Press the email address and then `OK`.
- 11 Press `OK`.

Change a Group

You can rename a group, add an email address to the group and delete an email address from the group.

- 1 Swipe left or right, or press ◀ or ▶ to display `Scan 2`.
- 2 Press `to E-mail Server`.
- 3 Press `Address Book`.
- 4 Press `Edit`.
- 5 Press `Change`.
- 6 Press ▲ or ▼ until you find the group you want to change.
- 7 Press the group name.
- 8 Do one of the following:
 - To rename the group, go to step 9.
 - To add an email address to the group, go to step 11.
 - To delete an email address from the group, go to step 11.

- 9 Press **Name**. The software keyboard appears on the Touchscreen.
- 10 Enter a new group name. Go to step 14.
- 11 Press **Add/Delete**.
- 12 Press **▲** or **▼** until you find the email address you want to add or delete.
- 13 Press the email address.
- 14 Press **OK**.

Delete a Group

- 1 Swipe left or right, or press **◀** or **▶** to display **Scan 2**.
- 2 Press **to E-mail Server**.
- 3 Press **Address Book**.
- 4 Press **Edit**.
- 5 Press **Delete**.
- 6 Press **▲** or **▼** until you find the group name you want to delete.
- 7 Press the group name, and then **OK**.
- 8 Press **Yes**.



Upload Scanned Documents to the Web (ADS-2800W / ADS-3600W)

Scan to Web lets you scan a document and upload it directly to Web Services. See the *Web Connect Guide*.

Change Scan to PC Settings (Windows®)

- 1 Click the  (ControlCenter4) icon in the task tray and then select **Open** from the menu. The **ControlCenter4** window appears.

NOTE

- The screens in this guide are from Windows® 7. Screens on your computer may vary depending on your operating system.
- If the  icon is not displayed in the task tray, click  (**Brother Utilities**) on your desktop, and then click the drop-down list and select your model name (if not already selected). Click **Scan** in the left navigation bar, and then click **ControlCenter4**.

- 2 Click the **Device Settings** tab (the example below uses **Home Mode**).

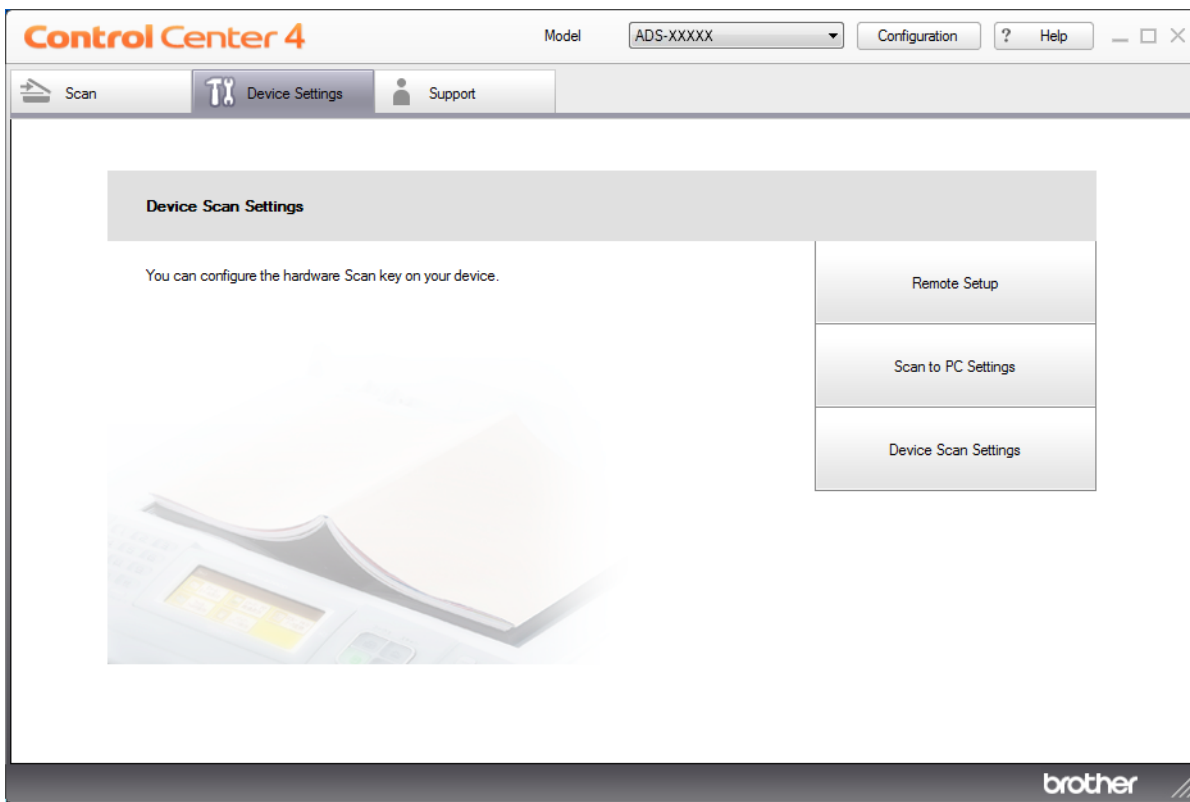

NOTE

If using **Advanced Mode**, click the  (Settings) icon to access **Device Settings**.



7

- 3 Click the **Device Scan Settings** button. The **Device Scan Settings** dialog box appears.

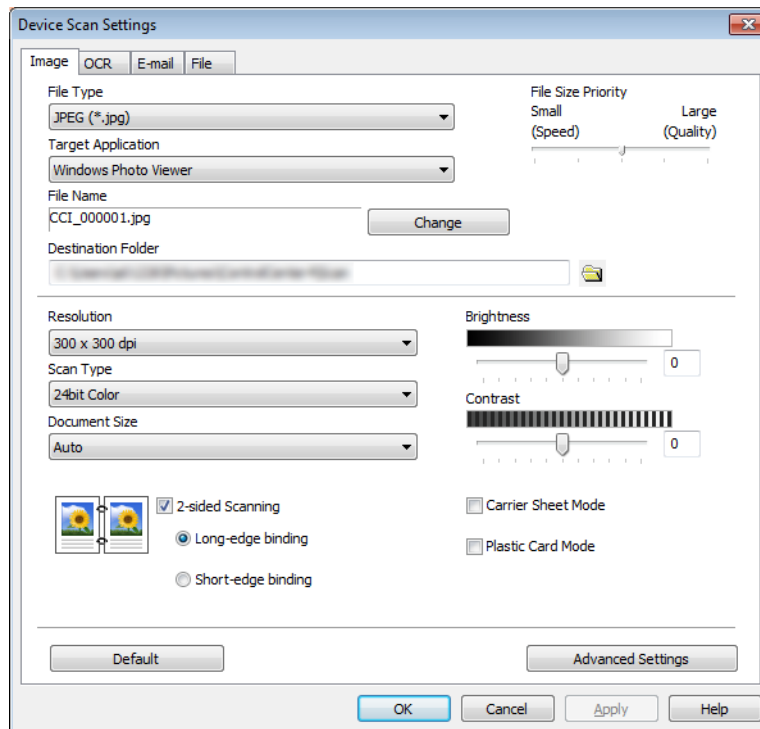

- 4 Click the tab for the Scan-to action you want to change (**Image**, **OCR**, **E-mail**, or **File**).
- 5 Change the settings.
The following settings can be changed.

Setting	Description	Applicable Feature			
		Image	OCR	E-mail	File
File Type	<p>Select the file type you want to use for the scanned data.</p> <p>NOTE</p> <ul style="list-style-type: none"> To save the document as a password-protected PDF, select Secure PDF (*.pdf) from the File Type drop-down list, click the  (Set PDF Password) button, and enter the password. Searchable PDF is a file format that includes the text data layer over a scanned image. This layer allows you to search the text on the image data. OCR Language in the OCR setting must be set to match the language in the searchable PDF. To save the document as a searchable PDF, select Searchable PDF (*.pdf) from the File Type drop-down list. Several file types such as TIFF, TIFF Multi-Page, PDF, Secure PDF and JPEG support file size compression. Select Uncompressed or Compressed to adjust the file size for TIFF or TIFF Multi-Page. For PDF, Secure PDF and JPEG, use the slider to adjust the file size (not available for Scan to OCR). 	Yes	Yes	Yes	Yes
Target Application	Select the destination application from the drop-down list.	Yes	Yes	-	-
OCR Language	Set to match the language of the scanned document's text.	-	Yes	-	-
File Name	Click the Change button for Image , OCR or E-mail to change the file naming attributes, such as Prefix, Add Date & Time, and so on.	Yes	Yes	Yes	Yes
Destination File Path	Click the Folder icon to change the folder where you want to save your scanned image.	Yes	Yes	Yes	-
File Name	To define file naming attributes, click the Change button.				
Destination Folder	Click the folder icon and browse to the folder where you would like to save your scanned document. Select the Show Folder check box to automatically display the destination folder after scanning.	Yes	Yes	Yes	No
Scan Location	Select Folder and browse to the folder you would like to save your scanned document to. Select the SharePoint and Connection Test to verify your site you would like to save your scanned document to.	-	-	-	Yes
File Size Priority	<p>Adjust the File Size Priority by moving the slider to the right or left.</p> <p>NOTE</p> <p>File Size Priority can be adjusted depending on your selected File Type.</p>	Yes	-	Yes	Yes

Setting	Description	Applicable Feature			
		Image	OCR	E-mail	File
Resolution	Select a scanning resolution from the Resolution drop-down list. Higher resolutions take more memory and transfer time, but produce a finer scanned image.	Yes	Yes	Yes	Yes
Scan Type	<p>Select from a range of scan color depth.</p> <p>Black & White Use for text or line art images.</p> <p>Gray (Error Diffusion) Use for photographic images or graphics. (Error Diffusion is a method for creating simulated grayscale images without using true gray dots. Black dots are put in a specific pattern to give a gray appearance.)</p> <p>True Gray Use for photographic images or graphics. This mode is more exact due to using up to 256 shades of gray.</p> <p>24bit Color Uses up to 16.8 million colors to scan the image. Although using 24bit Color creates an image with the most accurate color reproduction, it requires the most memory and has the longest transfer time.</p> <p>Auto Uses suitable colors for your document automatically.</p>	Yes	Yes	Yes	Yes
Document Size	<p>Document size is set to Auto by default. You can scan documents of any size without making adjustments to Document Size. For faster scan speeds, select the exact size of your document from the Document Size drop-down list.</p> <p>NOTE</p> <ul style="list-style-type: none"> • If you select a 1 to 2 document size, the scanned image will be divided into two documents that are half the size of the setting. If you select 1 to 2(A4), the scanned image will be divided into two A5-size documents. • To do 1 to 2 scanning, clear the Auto Image Rotation check box in the Advanced Settings dialog box. • If you select a 2 in 1 document size, two scanned images will be combined into one document. 	Yes	Yes	Yes	Yes

Setting	Description	Applicable Feature			
		Image	OCR	E-mail	File
Brightness	Adjust the setting (-50 to 50) to get the best image. The default value of 0 represents an average and is suitable for most images. Set the Brightness level by dragging the slider to the right or left to lighten or darken the image. You can also enter a value in the box to set the level. If the scanned image is too light, set a lower Brightness level and scan the document again. If the image is too dark, set a higher Brightness level and scan the document again.	Yes	Yes	Yes	Yes
Contrast	Adjust the setting (-50 to 50) to get the best image. The default value of 0 represents an average and is suitable for most images. Increase or decrease the contrast level by moving the slider to the right or left. An increase emphasizes dark and light areas of the image, while a decrease reveals more details in gray areas. You can also enter a value in the box to set the Contrast . NOTE The Contrast setting is only available when setting Scan Type to Auto , Gray (Error Diffusion) , True Gray or 24bit Color .	Yes	Yes	Yes	Yes
Default	Restore all settings to their factory default values.	Yes	Yes	Yes	Yes
Carrier Sheet Mode	Scan the following documents using the Carrier Sheet. For this mode, select any setting other than Auto from the Document Size drop-down list. <ul style="list-style-type: none"> ■ Large-sized Documents (A3, B4 and Ledger) Fold the document in half and insert it in the Carrier Sheet for 2-sided (duplex) scanning, then both front and back pages will be combined into a single page. Select 2 in 1(A4) for an A3 document, 2 in 1(B5) for a B4 document or 2 in 1(Letter) for a Ledger document from the Document Size drop-down list. ■ Important documents (photos, contracts) ■ Thin paper (receipts) ■ Irregularly-shaped paper (clippings) NOTE <ul style="list-style-type: none"> • Load only one Carrier Sheet at a time. • Insert the document in the center of the Carrier Sheet and align the top of the document with the top of the Carrier Sheet. 	Yes	Yes	Yes	Yes

Setting	Description	Applicable Feature			
		Image	OCR	E-mail	File
Plastic Card Mode	<p>Scan cards, such as driver's licenses or insurance cards, using these automatic settings:</p> <ul style="list-style-type: none"> ■ Resolution: 600 x 600 dpi ■ Document Size: 2 in 1 (Auto) ■ 2-sided Scanning: On (Short-edge binding) ■ Auto Deskew: On ■ Multifeed Detection: Off ■ Auto Image Rotation: Off <p>NOTE</p> <ul style="list-style-type: none"> • To scan a plastic card with different settings, set Plastic Card Mode off, Resolution to 600 dpi, and Multifeed Detection to Off. • Load up to five plastic cards at a time. 	Yes	Yes	Yes	Yes

6 Click the **Advanced Settings** button. The **Advanced Settings** dialog box appears.

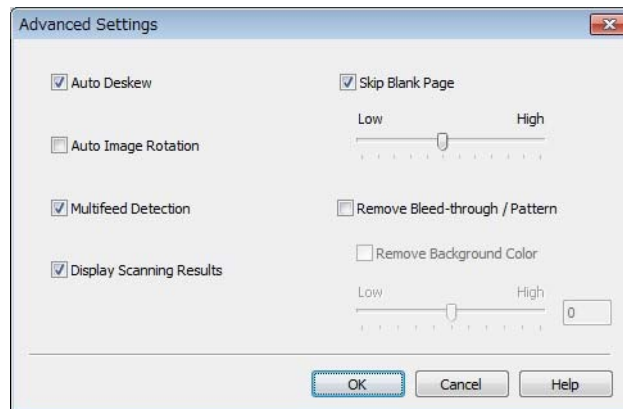

- 7 Change the settings.
The following settings can be changed.

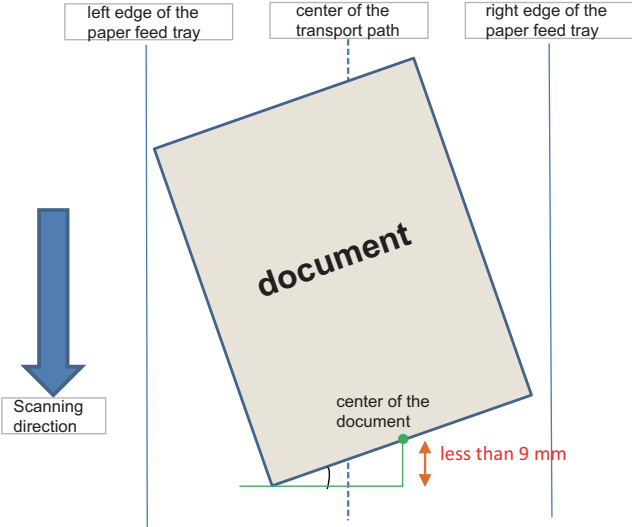
Setting	Description	Applicable Feature				
		Image	OCR	E-mail	File	Print
Auto Deskew	<p>Corrects the skew (less than 0.36 in. (9 mm) from the center of the document to the edge) of the scanned data.¹</p> 	Yes	Yes	Yes	Yes	Yes
Auto Image Rotation	Changes the direction of the document based on the text orientation. ¹	Yes	Yes	Yes	Yes	Yes
Remove Bleed-through / Pattern / Remove Background Color	<p>Prevents bleed through on a two-sided document, and also allows you to remove the base color of documents, such as newspapers, to make the scanned data more recognizable.¹</p> <p>The sensitivity of the Remove Bleed-through / Pattern / Remove Background Color function can be adjusted with the sliders. Moving the slider toward “High” will make the scanner more likely to Remove Bleed-through / Pattern / Remove Background Color, while moving it toward “Low” will make the scanner less likely to Remove Bleed-through / Pattern / Remove Background Color.</p>	Yes	Yes	Yes	Yes	Yes
Skip Blank Page	Removes blank pages of the document from the scanning results. ¹	Yes	Yes	Yes	Yes	Yes
Multifeed Detection	Uses a ultrasonic sensor to detect when a multifeed has occurred. When this function detects a multifeed, confirm that the data scanned before the multifeed has been saved, and then start scanning again at the next page or the beginning of the document.	Yes	Yes	Yes	Yes	Yes

Setting	Description	Applicable Feature				
		Image	OCR	E-mail	File	Print
Display Scanning Results	Shows the numbers of total pages saved and blank pages skipped on your computer screen.	Yes	Yes	Yes	Yes	Yes

¹ Depending upon the condition of the original document, this function may not work properly.

- 8 Click **OK** to close the **Advanced Settings** dialog box.
- 9 Click **OK** to close the **Device Scan Settings** dialog box.

Change Scan to PC Settings (Macintosh)

- 1 Click the  (ControlCenter2) icon in the Dock. The **ControlCenter2** window appears.



- 2 While holding down the **Control** key, click a button for the Scan-to action you want to change (**Image**, **OCR**, **E-mail**, or **File**). The Scan-to action dialog box appears (the example below uses **Image**).
- 3 Click the **Device Button** tab.

7

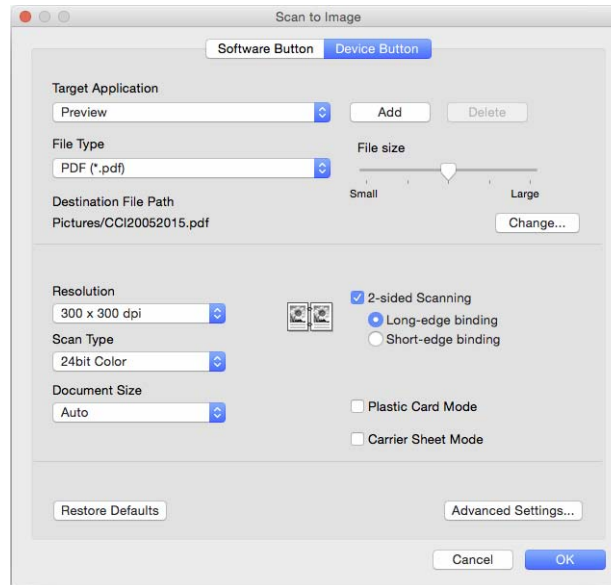

- 4 Change the settings.
The following settings can be changed.

Setting	Description	Applicable Feature			
		Image	OCR	E-mail	File
Target Application	<p>Select which application is used to open scanned data. Only applications installed on your computer can be selected.</p> <ul style="list-style-type: none"> ■ Add button Add an application to the pop-up menu. Enter the Application Name (up to 30 characters) and select your preferred application by clicking the Browse button. Also select the File Type from the pop-up menu. ■ Delete button Delete an application that you have added. Select the Application Name and click the Delete button. 	Yes	Yes	Yes	-
File Type	<p>Select the file type you want to use for the scanned data.</p> <p>NOTE</p> <ul style="list-style-type: none"> • To save the document as a password-protected PDF, select Secure PDF (*.pdf) for File Type, and then enter the password in the Set PDF Password dialog box. • Searchable PDF is a file format that includes the text data layer over a scanned image. This layer allows you to search the text on the image data. OCR Language in the OCR setting must be set to match the language in the searchable PDF. • To save the document as a searchable PDF, select Searchable PDF (*.pdf) from the File Type drop-down list. • Several file types such as TIFF, TIFF Multi-Page, PDF, Secure PDF and JPEG support file size compression. Select Uncompressed or Compressed to adjust the file size for TIFF or TIFF Multi-Page. For PDF, Secure PDF and JPEG, use the slider to adjust the file size (not available for Scan to OCR). 	Yes	Yes	Yes	Yes
File Size	<p>Adjust the File Size by moving the slider to the right or left.</p> <p>NOTE File Size can be adjusted depending on your selected File Type.</p>	Yes	-	Yes	Yes
OCR Software	Shows the application to extract the editable text data from the document.	-	Yes	-	-
OCR Language	Set to match the language of the scanned document's text.	-	Yes	-	-

Setting	Description	Applicable Feature			
		Image	OCR	E-mail	File
File Name	Click the Change button for Image , OCR or E-mail . Enter a prefix for the file name if needed.	Yes	Yes	Yes	Yes
Destination File Path	Click the Browse button to change the folder where you want to save your scanned image.	Yes	Yes	Yes	-
File Name	To define file naming attributes, click the Change button.				
Destination Folder	Click the Browse button and navigate to the folder where you want to save your scanned document. Check Show Folder to automatically display the destination folder after scanning.	-	-	-	Yes
Resolution	Select a scanning resolution from the Resolution pop-up menu. Higher resolutions take more memory and transfer time, but produce a finer scanned image.	Yes	Yes	Yes	Yes
Scan Type	<p>Select from a range of scan color depth.</p> <p>Black & White Use for text or line art images.</p> <p>Gray (Error Diffusion) Use for photographic images or graphics. (Error Diffusion is a method for creating simulated grayscale images without using true gray dots. Black dots are put in a specific pattern to give a gray appearance.)</p> <p>True Gray Use for photographic images or graphics. This mode is more exact due to using up to 256 shades of gray.</p> <p>24bit Color Uses up to 16.8 million colors to scan the image. Although using 24bit Color creates an image with the most accurate color reproduction, it requires the most memory and has the longest transfer time.</p> <p>Auto Uses suitable colors for your document automatically.</p>	Yes	Yes	Yes	Yes

Setting	Description	Applicable Feature			
		Image	OCR	E-mail	File
Document Size	<p>Document size is set to Auto by default. You can scan documents of any size without making adjustments to Document Size. For faster scan speeds, select the exact size of your document from the Document Size pop-up menu.</p> <p>NOTE</p> <ul style="list-style-type: none"> If you select a 1 to 2 document size, the scanned image will be divided into two documents that are half the size of the setting. For example, if you select 1 to 2(A4), the scanned image will be divided into two A5-size documents. To do 1 to 2 scanning, clear the Auto Image Rotation check box in the Advanced Settings dialog box. If you select a 2 in 1 document size, two scanned images will be combined into one document. 	Yes	Yes	Yes	Yes
Restore Defaults	Restore all settings to their factory default values.	Yes	Yes	Yes	Yes
Carrier Sheet Mode	<p>Scan the following documents using the Carrier Sheet. For this mode, select any setting other than Auto from the Document Size pop-up menu.</p> <ul style="list-style-type: none"> ■ Large-sized Documents (A3, B4 and Ledger) Fold the document in half and insert it in the Carrier Sheet for 2-sided (duplex) scanning, then both front and back pages will be combined into a single page. Select 2 in 1(A4) for an A3 document, 2 in 1(B5) for a B4 document or 2 in 1(Letter) for a Ledger document from the Document Size pop-up menu. ■ Important documents (photos, contracts) ■ Thin paper (receipts) ■ Irregularly-shaped paper (clippings) <p>NOTE</p> <ul style="list-style-type: none"> Load only one Carrier Sheet at a time. Insert the document in the center of the Carrier Sheet and align the top of the document with the top of the Carrier Sheet. 	Yes	Yes	Yes	Yes

Setting	Description	Applicable Feature			
		Image	OCR	E-mail	File
Plastic Card Mode	<p>Scan cards, such as driver's licenses or insurance cards, using these automatic settings:</p> <ul style="list-style-type: none"> ■ Resolution: 600 x 600 dpi ■ Document Size: 2 in 1 (Auto) ■ Auto Deskew: Off ■ 2-sided Scanning: On (Short-edge binding) ■ Multifeed Detection: Off ■ Auto Image Rotation: Off <p>NOTE</p> <ul style="list-style-type: none"> • To scan a plastic card with different settings, set Plastic Card Mode off, Resolution to 600 dpi, and Multifeed Detection to Off. • Load up to five plastic cards at a time. 	Yes	Yes	Yes	Yes

5 Click the **Advanced Settings** button. The **Advanced Settings** dialog box appears.

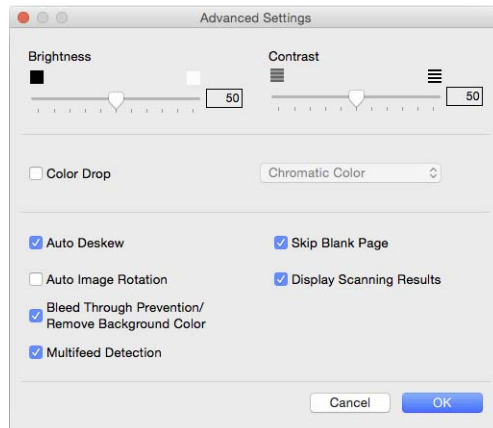

- 6 Change the settings.
The following settings can be changed.

Setting	Description	Applicable Feature			
		Image	OCR	E-mail	File
Brightness	Adjust the setting (0 to 100) to get the best image. The default value of 50 represents an average and is suitable for most images. Set the Brightness level by dragging the slider to the right or left to lighten or darken the image. If the scanned image is too light, set a lower Brightness level and scan the document again. If the image is too dark, set a higher Brightness level and scan the document again.	Yes	Yes	Yes	Yes
Contrast	Adjust the setting (0 to 100) to get the best image. The default value of 50 represents an average and is suitable for most images. Increase or decrease the contrast level by moving the slider to the right or left. An increase emphasizes dark and light areas of the image, while a decrease reveals more details in grey areas. NOTE The Contrast setting is only available when setting Scan Type to Auto, Gray (Error Diffusion), True Gray or 24bit Color .	Yes	Yes	Yes	Yes
Color Drop	Removes specific colors from your scanned data. Select one of the following: ■ Chromatic colors Use to remove all colors except Black. ■ Red Use to remove the Red color. ■ Green Use to remove the Green color. ■ Blue Use to remove the Blue color. ■ Custom Select the color that you want to remove.	Yes	Yes	Yes	Yes
Auto Deskew	Corrects the skew (less than 0.36 in. (9 mm) from the center of the document to the edge) of the scanned data.	Yes	Yes	Yes	Yes
Auto Image Rotation	Changes the direction of the document based on the text orientation.	Yes	Yes	Yes	Yes

Setting	Description	Applicable Feature			
		Image	OCR	E-mail	File
Bleed Through Prevention/ Remove Background Color	Prevents bleed through on a two-sided document, and also allows you to remove the base color of documents, such as newspapers, to make the scanned data more recognizable. ¹	Yes	Yes	Yes	Yes
Skip Blank Page	Removes blank pages of the document from the scanning results.	Yes	Yes	Yes	Yes
Multifeed Detection	Uses a ultrasonic sensor to detect when a multifeed has occurred. When this function detects a multifeed, confirm that the data scanned before the multifeed has been saved, and then start scanning again at the next page or the beginning of the document.	Yes	Yes	Yes	Yes
Display Scanning Results	Shows the numbers of total pages saved and blank pages skipped on your computer screen.	Yes	Yes	Yes	Yes

¹ Depending upon the condition of the original document, this function may not work properly.

- 7 Click **OK**.
- 8 Click **OK** to close the settings dialog box.

Scan Options Using the Touchscreen (ADS-2800W / ADS-3600W)

Skip Blank Page Function

If you set Skip Blank Page to On, it removes blank pages of the document from the scanning results.

The sensitivity of the Skip Blank Page function can be adjusted with the slider. Moving the slider toward “High” will make the scanner more likely to skip pages, while moving it toward “Low” will make the scanner less likely to skip pages.

- 1 Swipe left or right to display the Scan-to action you want to do (to PC, to Network, to FTP/SFTP, to E-mail Server, to SharePoint, to USB).
- 2 Press **Options**.
- 3 Press **Skip Blank Page**.
- 4 Press **On (or Off)**.

Adjust the Scanning Position

You can adjust the position at which documents are scanned if the output position of images shifts or if images are squeezed together or stretched out vertically.

- 1 Swipe left or right to display the scan-to action you want to do (to PC, to Network, to FTP/SFTP, to E-mail Server, to SharePoint, to USB).
- 2 Press **Options**.
- 3 Press **Advanced Settings**.
- 4 Press **Margin Settings**.
- 5 Select **-3 to 3**.

Scan a Specific Area

Cropping allows you to scan a portion of the document.

- 1 Press  (**Settings**).
- 2 Press **Initial Setup**.
- 3 Press **Scan offset correction**.
- 4 Select **Front Page Offset** or **Back Page Offset**.

Adjust Brightness

You can adjust the brightness of the scan document. Adjust the setting (-50 to +50) to get the best image. If the scanned image is too light, set a lower Brightness level and scan the document again. If the image is too dark, set a higher Brightness level and scan the document again.

- 1 Swipe left or right to display the Scan-to action you want to do (to PC, to Network, to FTP/SFTP, to E-mail Server, to SharePoint, to USB).
- 2 Select the Scan-to action you want to do.
- 3 Press **Options**.
- 4 Press **Advanced Settings**.
- 5 Press **Brightness**.
- 6 Select -50 to 50.

Adjust Contrast

For most documents the default setting of 0 will give the best results. 0 automatically chooses the appropriate contrast for your document. If your document is very light or very dark, changing the contrast may improve the quality of the scan. If the scanned image is too light, set a lower contrast level and scan the document again. If the image is too dark, set a higher contrast level and scan the document again.

- 1 Swipe left or right to display the Scan-to action you want to do (to PC, to Network, to FTP/SFTP, to E-mail Server, to SharePoint, to USB).
- 2 Select the scan-to action you want to perform.
- 3 Press **Options**.
- 4 Press **Advanced Settings**.
- 5 Press **Contrast**.
- 6 Select a value from -50 to 50.

Automatically Detect Whether a Document Uses Color

This feature automatically detects whether the document uses color and generates a scanned image of it. For documents that mix color and black and white pages, color pages will be scanned in Color mode, while black and white pages will be scanned in Black & White mode.

- 1 Swipe left or right to display the Scan-to action you want to do (to PC, to Network, to FTP/SFTP, to E-mail Server, to SharePoint, to USB).
- 2 Select the Scan-to action you want to do.
- 3 Press **Options**.
- 4 Press **Scan Type**.
- 5 Select **Color, Gray, Black & White or Auto**.

Color Tone Adjustment

Allows you to adjust the brightness, contrast, shadow, highlight, and gamma during gray and color scanning.

- 1 Swipe left or right to display the scan-to action you want to perform (to PC, to Network, to FTP/SFTP, to E-mail Server, to SharePoint, to USB).
- 2 Select the scan-to action you want to perform.
- 3 Press **Options**.
- 4 Press **Advanced Settings**.
- 5 Press **Color Tone Adjustment**.
- 6 Adjust the **Brightness, Contrast, Shadow, Highlight and Gamma**.

Auto Color Detect Adjust



When the scan type is set to **Auto**, you can adjust the detection level of color, B&W and grayscale.

- 1 Swipe left or right to display the scan-to action you want to perform (to PC, to Network, to FTP/SFTP, to E-mail Server, to SharePoint, to USB).
- 2 Select the scan-to action you want to perform.
- 3 Press **Options**.
- 4 Press **Advanced Settings**.
- 5 Press **Auto Color Detect Adjust**.
- 6 Adjust the color detection level.

Monitor the Machine's Status from Your Computer (Windows®)

The Status Monitor utility is a configurable software tool for monitoring the status of one or more devices, allowing you to get immediate notification of error messages.

Do one of the following:

- Double-click the  (**Status Monitor**) icon in the task tray.
- Click  (**Brother Utilities**) on your desktop, and then click the drop-down list and select your model name (if not already selected). Click **Tools** in the left navigation bar, and then click **Status Monitor**. The Brother Status Monitor screen appears.

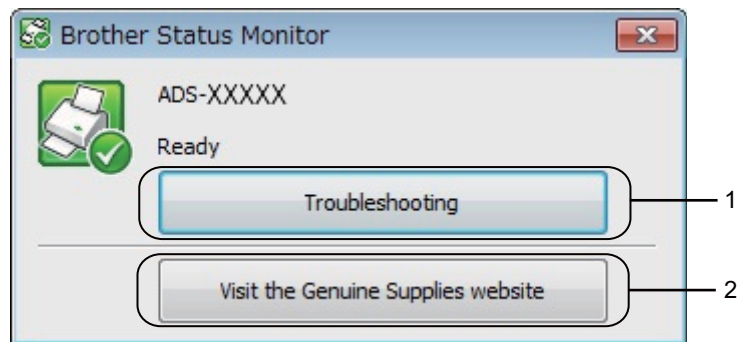

1 Troubleshooting





Click to access the Status Monitor troubleshooting web site.

2 Visit the Genuine Supplies website

Click to access the Brother genuine supplies web site.

Status Monitor Indicators

The **Brother Status Monitor** icon changes color based on your machine's status.

	A green icon indicates that your scanner is in a normal stand-by state.
	A yellow icon indicates a warning.
	A red icon indicates an error has occurred.
	A gray icon indicates that your scanner is offline.

- 1 Click the  (ControlCenter4) icon in the Dock. The **ControlCenter4** window appears.

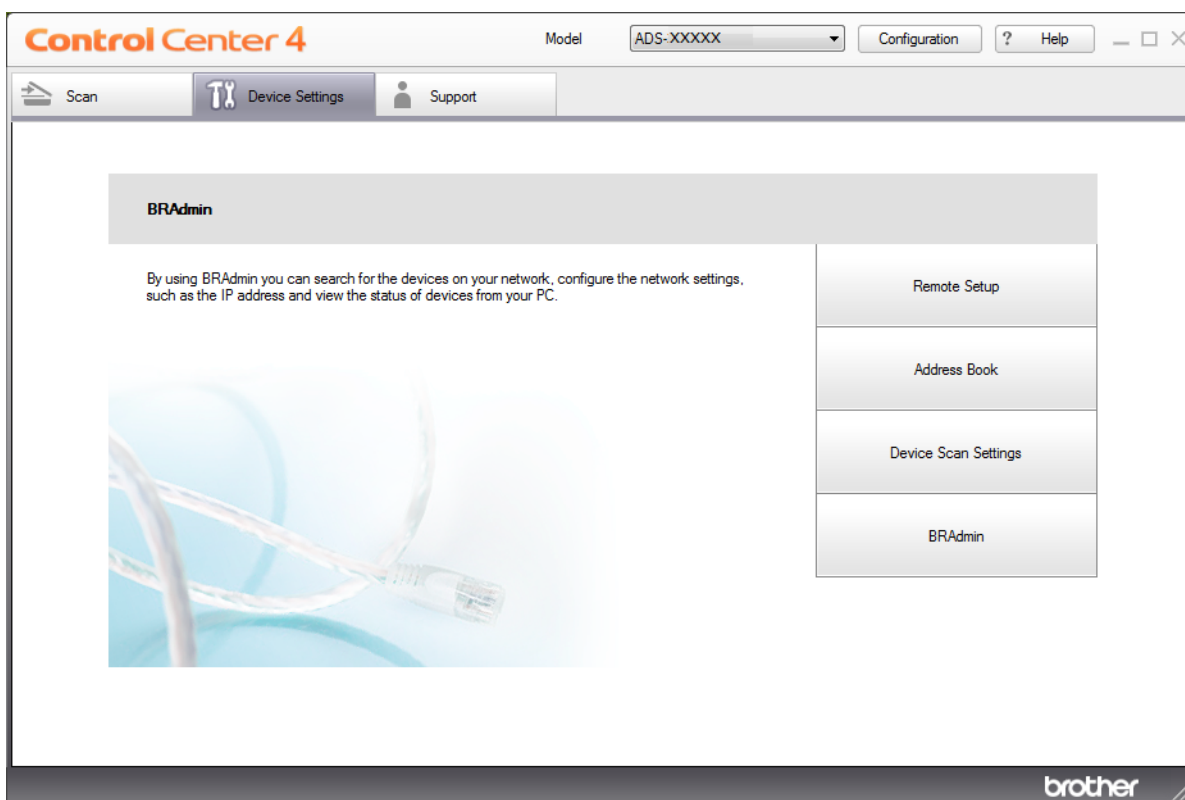

- 2 Click **Configuration**, and then select **Preferences**.
The **ControlCenter4 Preferences** window appears.

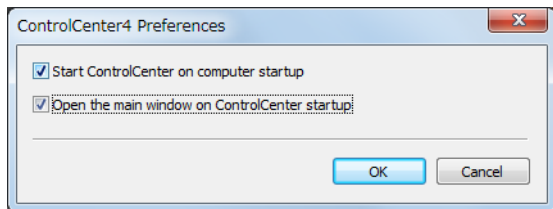

- 3 Select (or clear) the **Start ControlCenter on computer startup** check box.
- 4 Click **OK**.

Monitor the Machine's Status from Your Computer (Macintosh)

The Status Monitor utility is a configurable software tool for monitoring the status of a device, allowing you to get immediate notification of error messages.

- 1 Click the  (ControlCenter2) icon in the Dock. The **ControlCenter2** window appears.
- 2 Click the **DEVICE SETTINGS** tab.

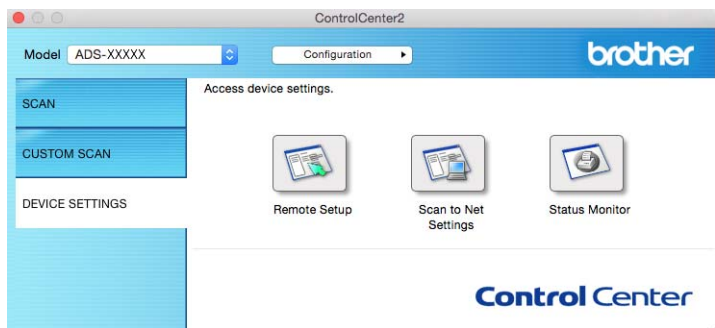

- 3 Click the **Status Monitor** button. The Status Monitor window appears and displays the status of your Brother machine.



1 Troubleshooting

Access the troubleshooting web site by clicking the **Troubleshooting** button.

2 Visit the Genuine Supplies website

Access the Brother genuine supplies web site by clicking the **Visit the Genuine Supplies website** button.

Turn the AutoLoad Feature On/Off (ControlCenter2)

- 1 Click the  (ControlCenter2) icon in the Dock.
The **ControlCenter2** window appears.

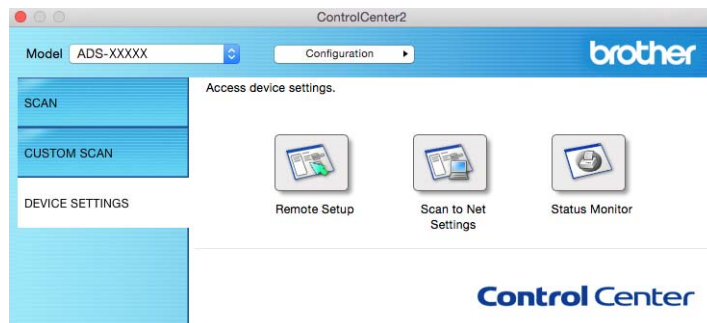

- 2 Click **Configuration**, and then select **Preferences**.
The **ControlCenter2 Preferences** window appears.

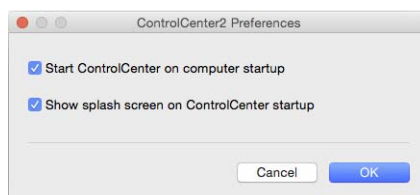

- 3 Select (or clear) the **Start ControlCenter on computer startup** check box.
- 4 Click **OK**.

Set Up the Brother Machine from Your Computer

The Remote Setup application lets you configure many machine settings from your computer. When you start the Remote Setup application, the settings on your Brother machine are downloaded automatically to your computer and displayed on the screen. If you change the settings on your computer, you can upload them directly to the machine.

NOTE

- If an error dialog box appears, Remote Setup will not start. Correct the error and then try to start Remote Setup again.
- Windows®
 - If your computer is protected by a firewall, and is unable to use Remote Setup, you may have to configure the firewall settings to allow communication through port numbers 137 and 161.
 - If you are using Windows® Firewall and you installed MFL-Pro Suite from the DVD-ROM, the necessary Firewall settings have already been made.

1 Start the ControlCenter application.

■ Windows®

- Click the  (ControlCenter4) icon in the task tray and then select **Open** from the menu. The **ControlCenter4** window appears.
- Click the **Device Settings** tab (the example below uses **Home Mode**).

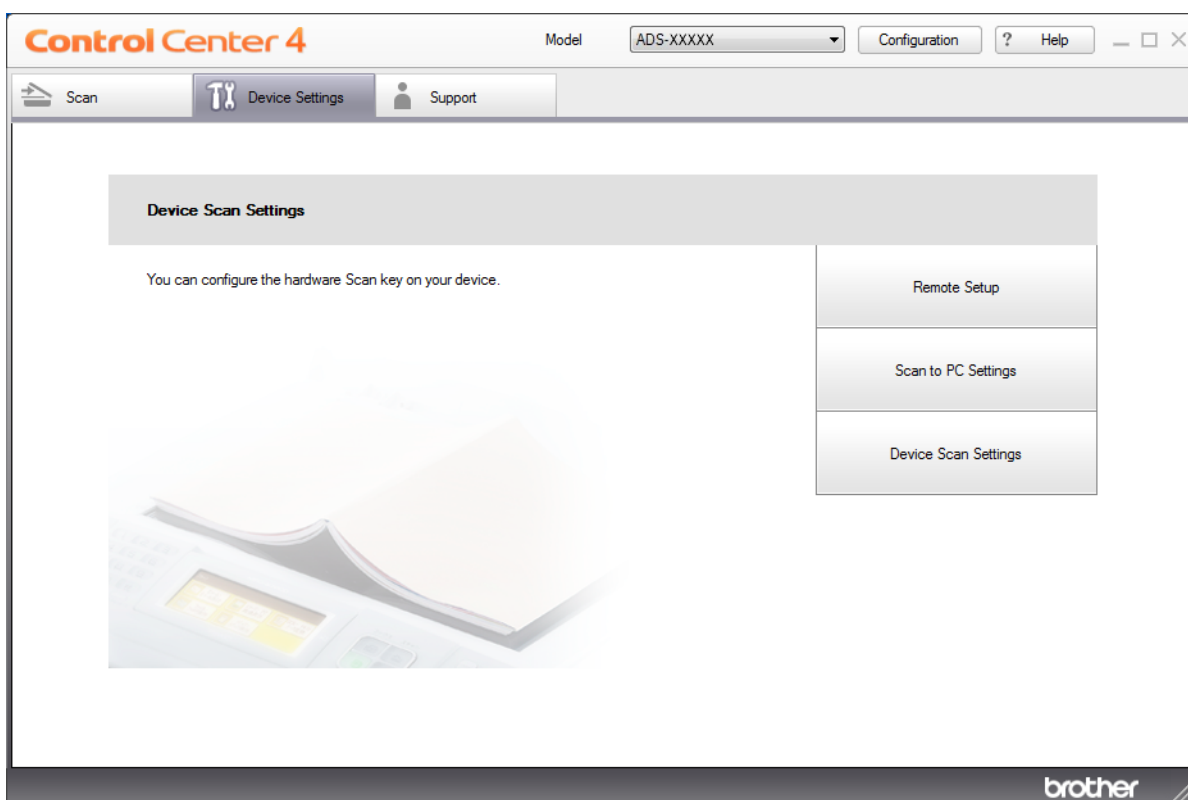

NOTE

If using **Advanced Mode**, click the  (Settings) icon to access **Device Settings**.



■ Macintosh

- a Click the  (ControlCenter2) icon in the Dock. The **ControlCenter2** window appears.
- b Click the **DEVICE SETTINGS** tab.

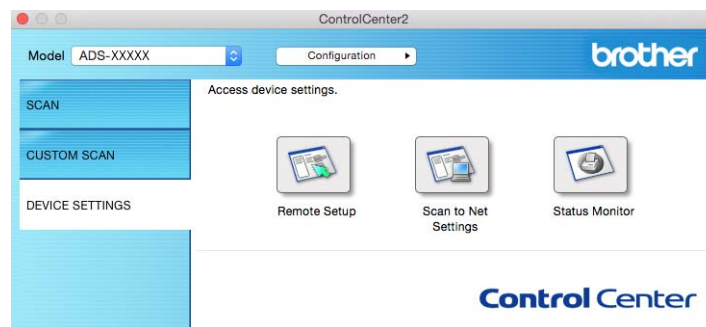

- 2 Click the **Remote Setup** button. The Remote Setup window appears.

NOTE

You can also start Remote Setup by following the instructions below:

- Windows®

Click  (**Brother Utilities**) on your desktop, and then click the drop-down list and select your model name (if not already selected). Click **Tools** in the left navigation bar, and then click **Remote Setup**.

- Macintosh

In the **Finder** menu bar, click **Go > Applications > Brother**, and then double-click the **Remote Setup** icon.

3 Select a menu in the folder tree and configure the settings as needed (the example below uses **General Setup** in Windows®).

■ **OK**

Click to start uploading data to the machine and exit the Remote Setup application. If an error message is displayed, re-enter the correct data, and then click **OK**.

■ **Cancel**

Click to exit the Remote Setup application without uploading data to the machine.

■ **Apply**

Click to upload data to the machine without exiting the Remote Setup application.

(ADS-2400N / ADS-3000N)

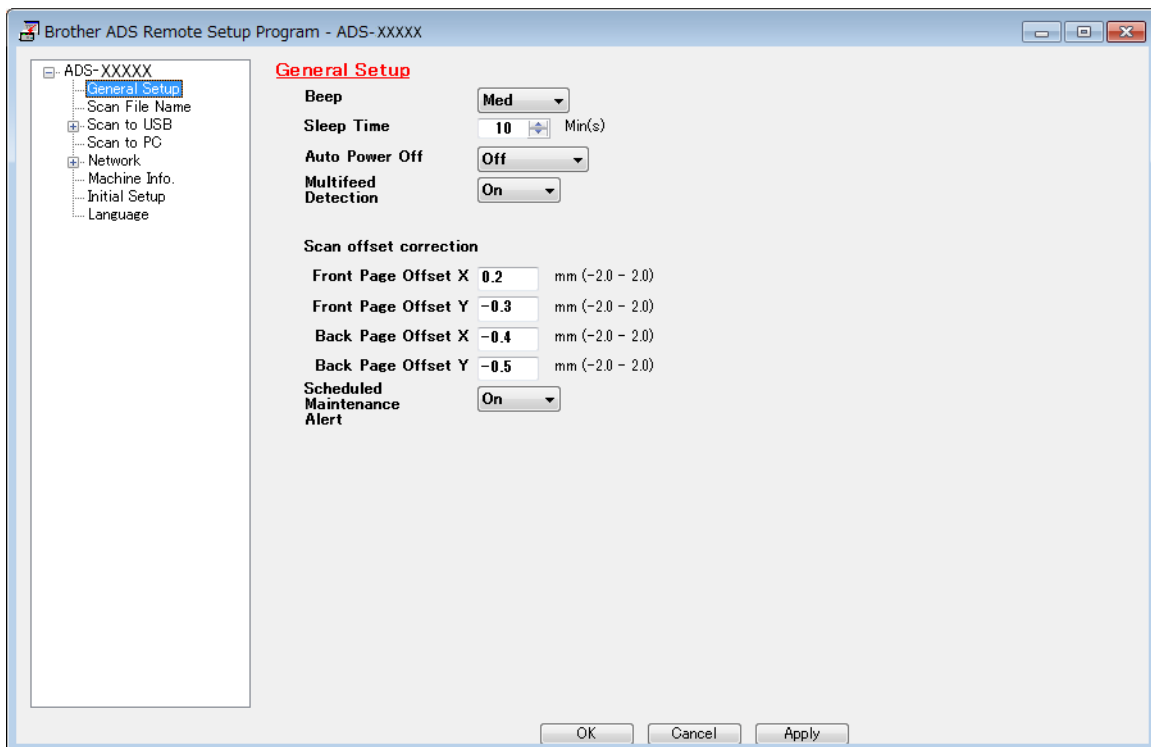

(ADS-2800W / ADS-3600W)

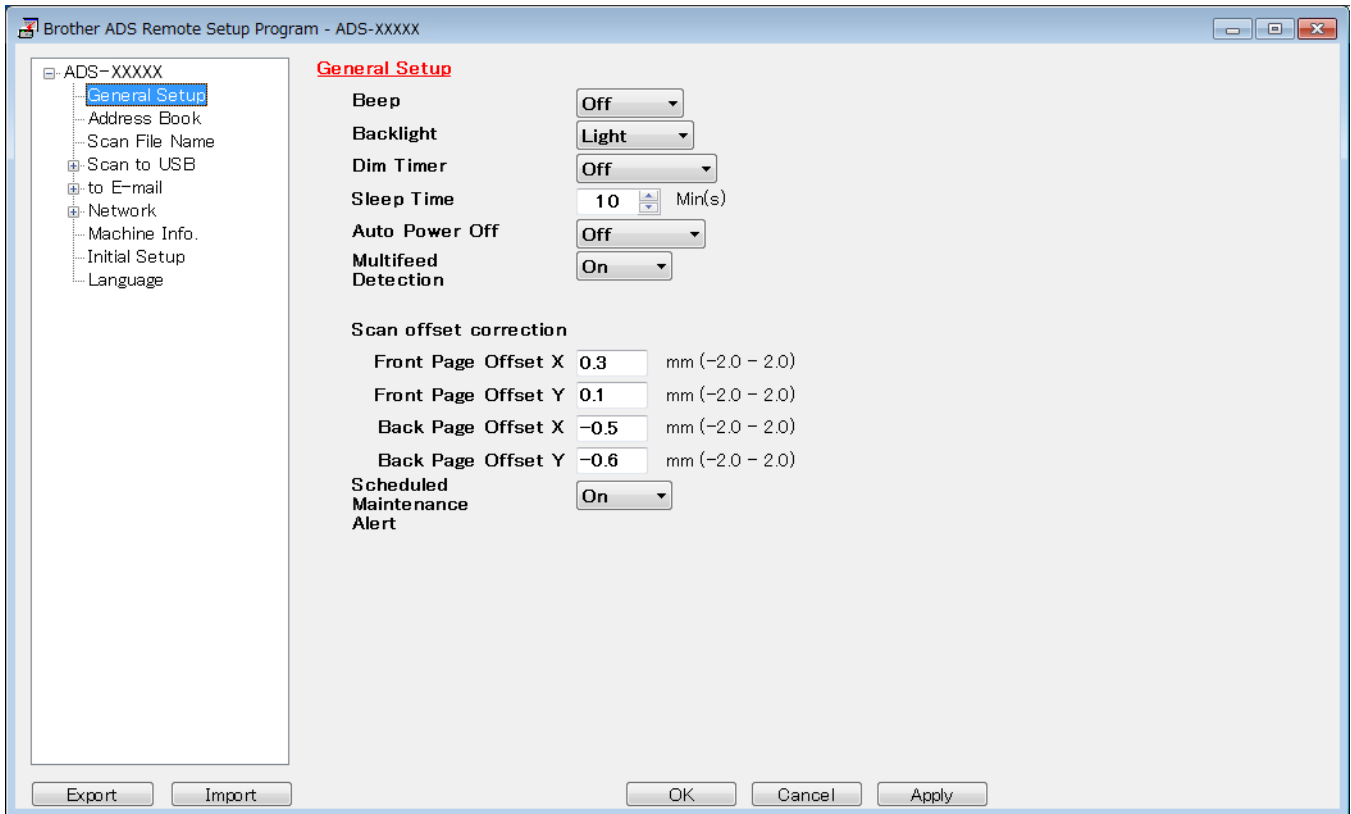

NOTE

- Click the **Export** button to save all settings for your machine.
- Windows®
 If your computer is protected by a firewall, and is unable to use **Remote Setup**, you may have to configure the firewall settings to allow communication through port numbers 137 and 161.
 If you are using Windows® Firewall and you installed MFL-Pro Suite from the DVD-ROM, the necessary Firewall settings have already been made.
- Macintosh
 If you change the machine that was registered to your computer during installation of the Full Driver & Software Package (see the Quick Setup Guide), or if the network environment has changed, you must specify the new machine. Open the **Device Selector** and choose the new machine. (See *Configure Network Scanning for Macintosh* on page 74.)
 If you require more advanced machine management, use the latest version of BRAdmin Professional 3 utility that is available as a download from support.brother.com. See the BRAdmin Professional 3 Help menu for more information about using BRAdmin Professional 3.

9

Routine Maintenance

Clean the Outside of the Machine

- 1 Wipe the Control Panel with a dry, soft, lint-free cloth to remove dust.

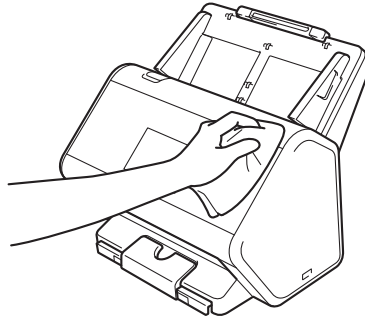

- 2 Unfold the Output Tray and Document stopper.

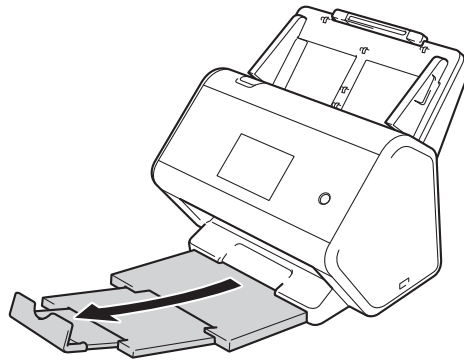

- 3 Wipe the inside of the Output Tray with a dry, soft, lint-free cloth to remove dust.

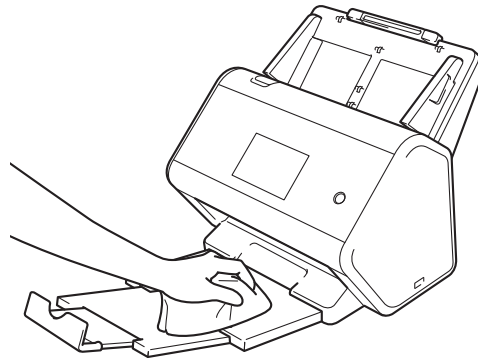

- 4 Firmly push the Output Tray into the machine.

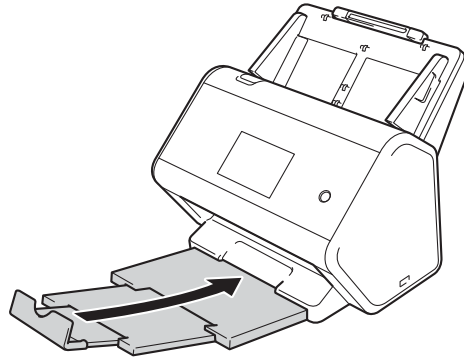

Clean the Scanner and Rollers

A spot of dirt or correction fluid on the glass strip may cause poor quality scans. Clean the inside of the scanner if a vertical line appears in the scanned data or if areas are missing in the scanned data.

- 1 Unplug the machine from the AC power outlet.
- 2 Remove the Extendable ADF ① while releasing the levers on the back side.

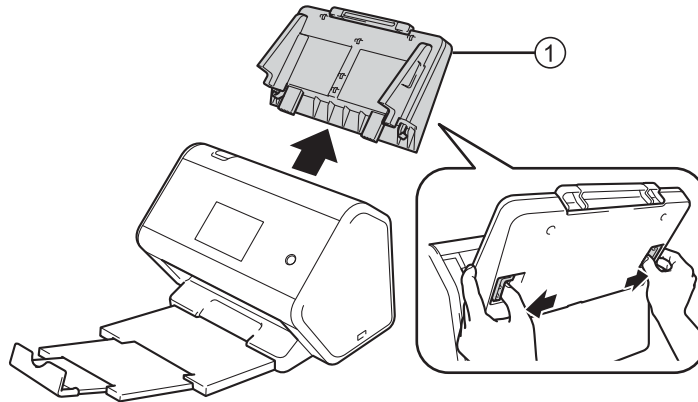

- 3 Open the Front Cover ①.

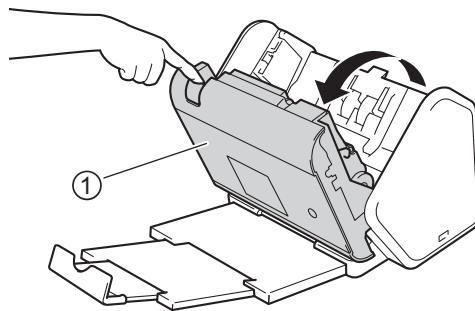

- 4 From the back of the machine, in the ADF unit clean the glass strips ① ② with a soft lint-free cloth moistened with water.

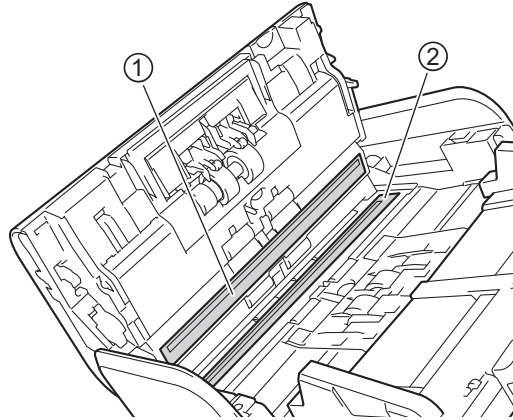

- 5 Pinch both sides of the Reverse Roller Cover ① and pull the Cover down.

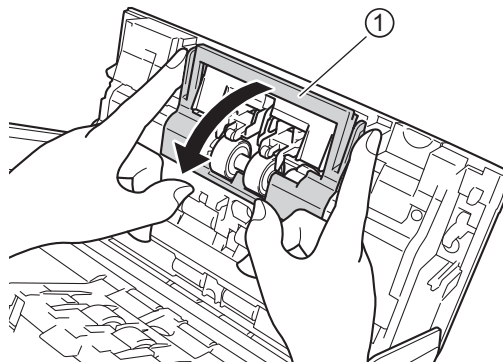

- 6 To remove the Reverse Roller, grab its shaft and pull it toward you and out to the right.

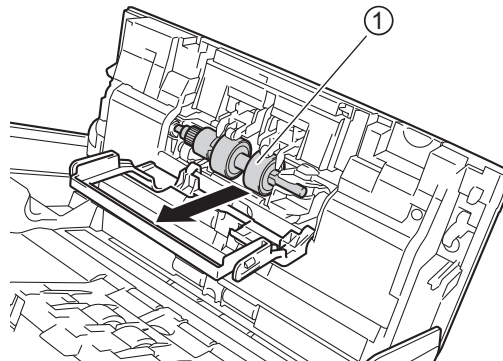

- 7 Clean the Reverse Roller with a soft lint-free cloth slightly moistened with water.

- Slide the Reverse Roller ① into the left opening to place new it back into the machine.

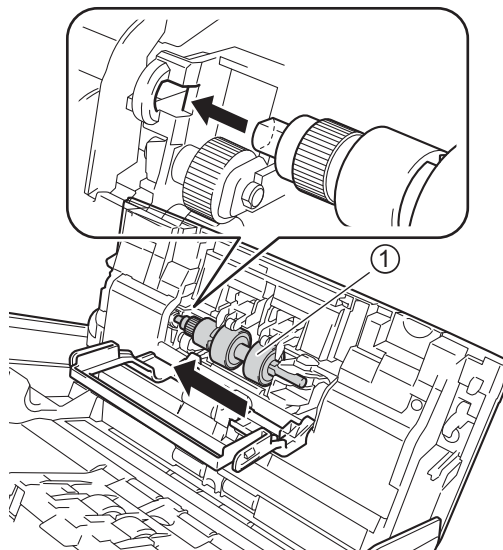

- Close the Reverse Roller Cover.
- Clean the Pick Up Roller from side to side with a soft lint-free cloth slightly moistened with water.

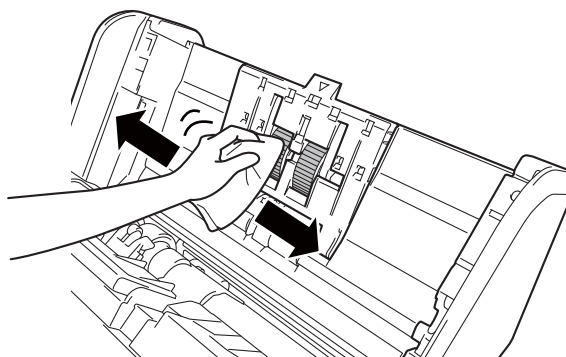

- Close the Front Cover and attach the Extendable ADF.

NOTE

(ADS-2800W / ADS-3600W)

When the `Scheduled Maintenance` alert is displayed, you must clean the machine promptly. If you do not, document jams and paper feed problems may occur.

Clean the glass strips with a non-flammable glass cleaner. When finished, run your fingertip over the glass to see if you feel anything on it. If you feel dirt or debris, clean the glass again, concentrating on that area. You may have to repeat the cleaning process three or four times. To test, scan a document after each cleaning attempt.



When there is a spot of dirt or correction fluid on the glass strip the scanned sample shows a vertical line.

After the glass strip is cleaned the vertical line is gone.

Replace Supplies

The Status Monitor will alert you when the machine detects that supplies are near the end of their life.

Part Names, Numbers, and Life Cycles

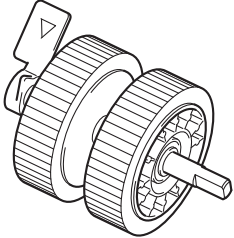
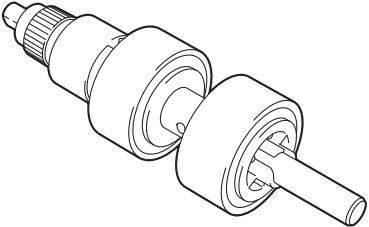
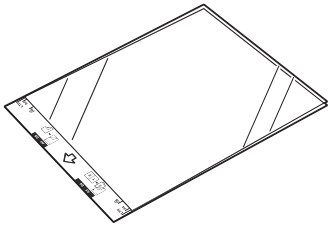
No.	Part Name	Part No.	Standard Replacement Cycle
1	Pick Up Roller 	PUR-A2001	200,000 sheets
2	Reverse Roller 	RVR-A2001	200,000 sheets
3	Carrier Sheet 	CS-A3001	500 times

NOTE

The Standard Replacement Cycle may vary depending on the usage environment, type of documents, and how often documents are scanned.

These parts are available at most Brother retailers. If you cannot find the part you need and you have a Visa, MasterCard, Discover, or American Express credit card, you can order parts directly from Brother. Visit us online for a complete selection of the Brother parts and supplies that are available for purchase.

NOTE

In Canada, only Visa and MasterCard are accepted.

In USA: 1-877-552-MALL (1-877-552-6255)
1-800-947-1445 (fax)

www.brothermall.com

In Canada:

www.brother.ca

Check Supplies Replacement Cycle (ADS-2400N / ADS-3000N)

- 1 Start the ControlCenter application.
 - Windows®
 - a Click the  (ControlCenter4) icon in the task tray and select **Open** from the menu. The **ControlCenter4** window appears.
 - b Click the **Device Settings** tab (the example below uses **Home Mode**).

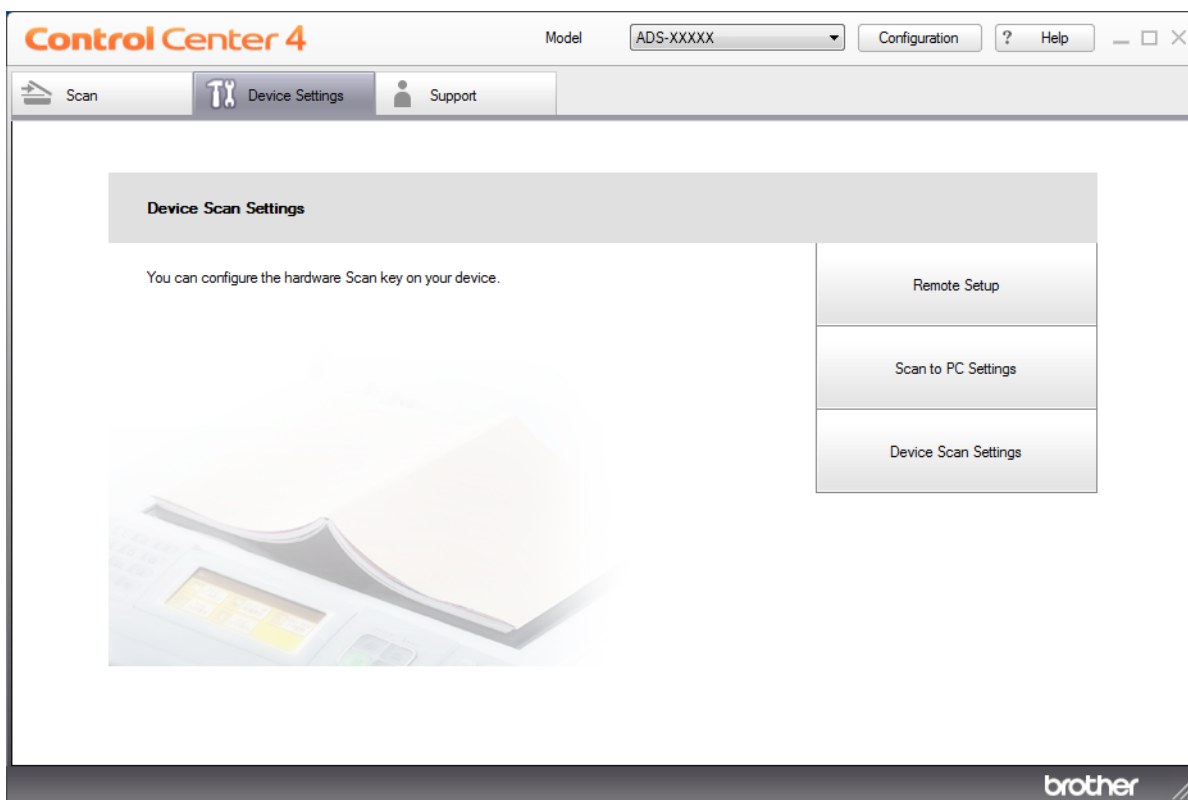

NOTE

If using **Advanced Mode**, click the  (Settings) icon to access **Device Settings**.



■ Macintosh

- a Click the  (ControlCenter2) icon in the Dock. The **ControlCenter2** window appears.
- b Click the **DEVICE SETTINGS** tab.

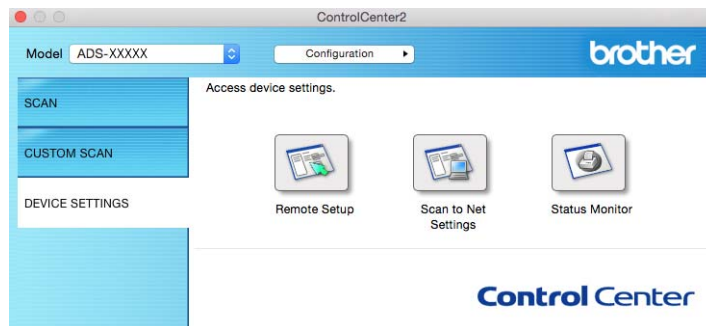

- 2 Click the **Remote Setup** button. The Remote Setup window appears.

- 3 Select **Machine Info.** in the folder tree. The window displays the **Pick up Roller Count** and **Reverse Roller Count** (the example below uses Windows®).

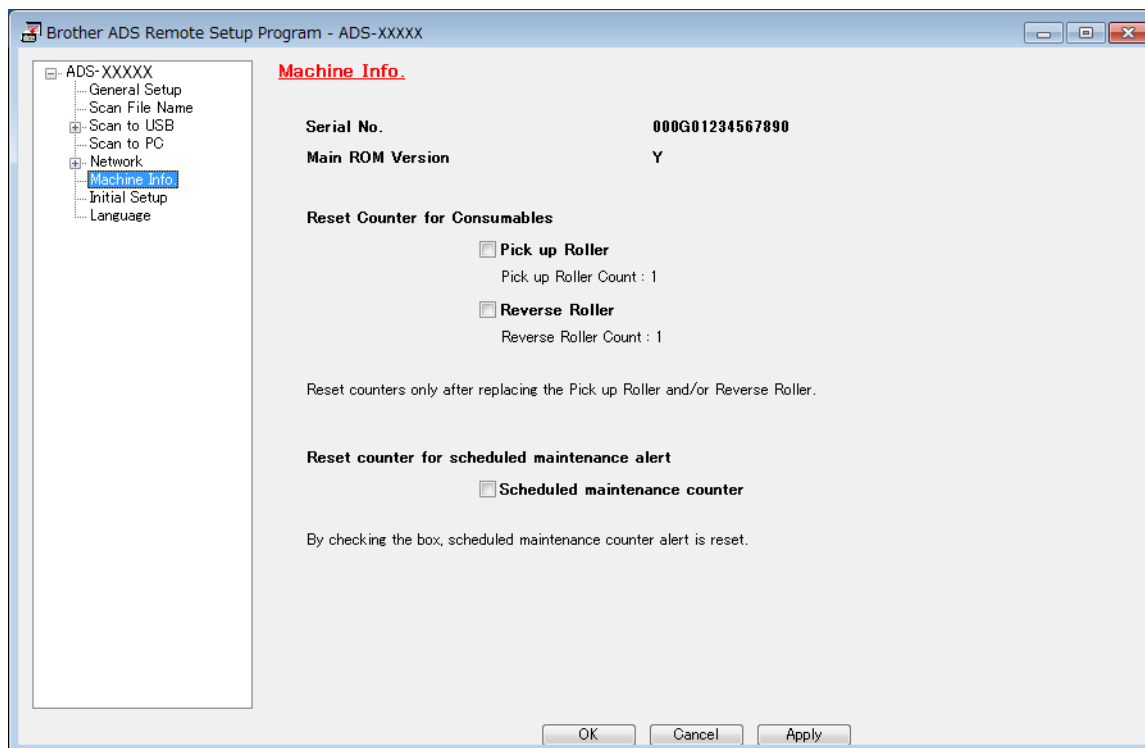

- 1 Start your web browser.
- 2 In your browser's address bar, type your machine's IP address (or your print server name). For example: <http://192.168.1.2>. You can use the machine's LCD to find its IP address.
- 3 Click **General**.
- 4 Click **Maintenance Information**.
- 5 Check the **Replace Count**.
- 6 Click **Submit**.

Check Supplies Replacement Cycle (ADS-2800W / ADS-3600W)

- 1 Press  (Settings).
- 2 Press ▲ or ▼ to display Machine Info.
- 3 Press Machine Info.
- 4 Press Usage Counter. The Touchscreen displays Reverse Roller Count and Pick up roller Count.

NOTE

If the Touchscreen indications warn you to replace the Reverse Roller and/or the Pick Up Roller, order the necessary parts and then replace the used parts with new ones.

Replace the Pick Up Roller

Your machine is equipped with a scan counter that automatically counts how many times the machine has scanned. When the machine scans 200,000 times, the Status Monitor displays a message to remind you to replace the Pick Up Roller.

- 1 Remove the Extendable ADF while releasing the levers on the back side.

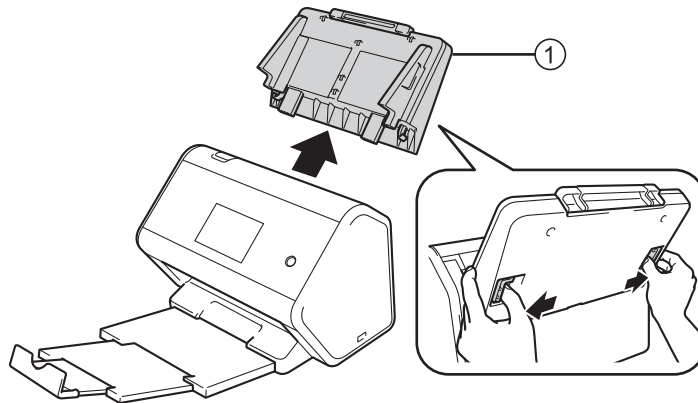

- 2 Open the Front Cover ①.

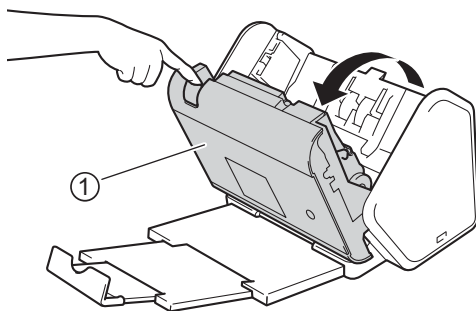

- 3 From the front of the machine, firmly pull open the tab of the Pick Up Roller Cover.

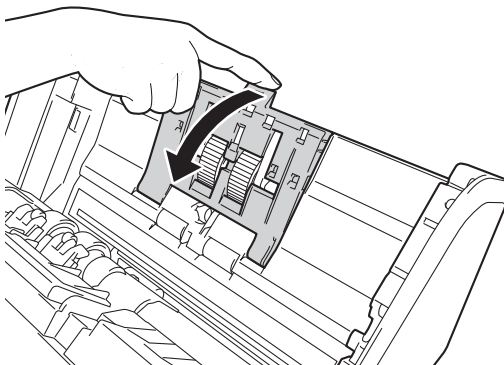

- 4 Pull down the green lever ① toward you and slide the Pick Up Roller out to the left.

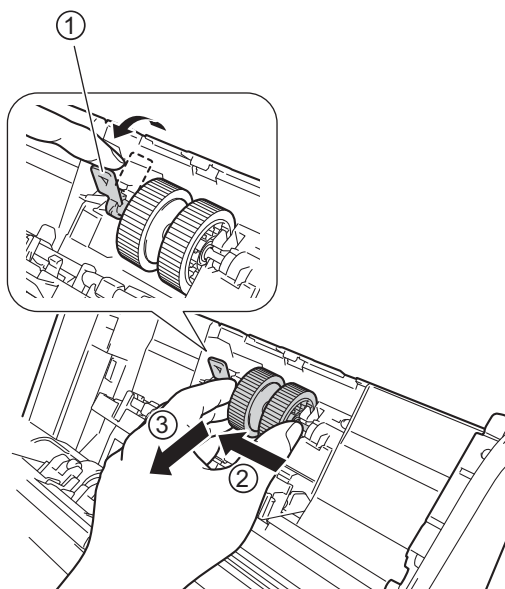

NOTE

Be careful not to break the green hook. If it does not pull down easily, gently use a little more force.

- 5 Slide the new slotted Pick Up Roller into the opening on the right and rotate the green lever until it locks into place.

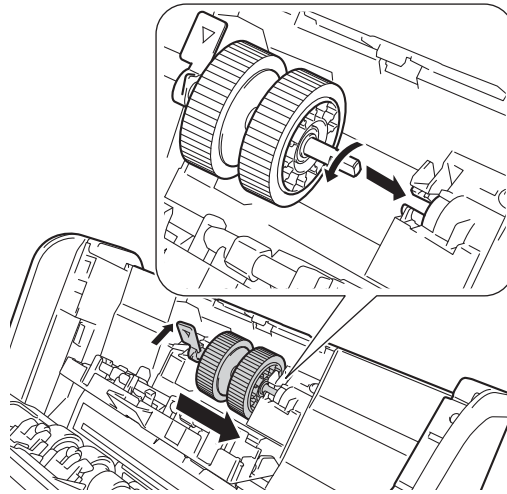

- 6 Close the Pick Up Roller Cover.
- 7 Close the Front Cover and attach the Extendable ADF.
- 8 Reset the Pick Up Roller's Counter (see *Reset the Usage Counters* on page 255).

NOTE

Confirm the following:

- The error message on the Status Monitor has been cleared.
- The Touchscreen or LED indication does not indicate Replace Pick Up Roller.
- Pull the green lever open firmly and quickly in step 4.
- Gently rotate the slotted green lever in step 4. Be careful not to force it.

Replace the Reverse Roller

Your machine is equipped with a scan counter that automatically counts how many times the machine has scanned. When the machine scans 200,000 times, the Status Monitor displays a message to remind you to replace the Reverse Roller.

- 1 Open the Front Cover ①.

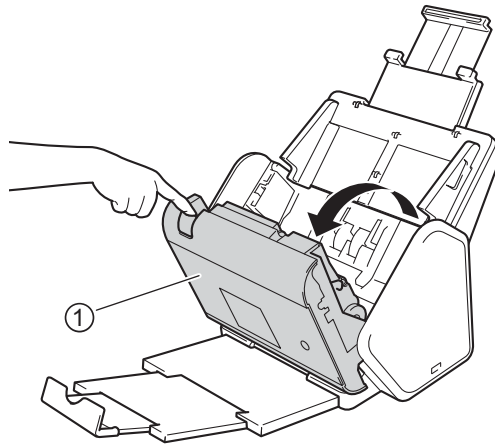

- 2 From the back of the machine, pinch the both sides of the Reverse Roller Cover ① and pull the Cover down.

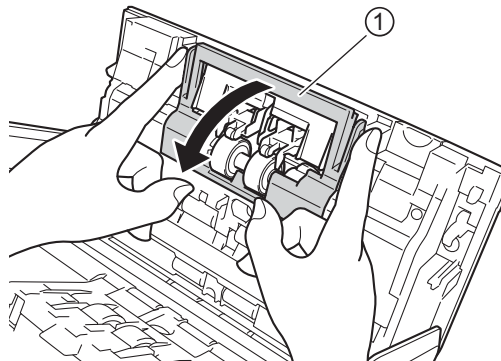

- 3 To remove the Reverse Roller, grab its shaft and pull it toward you and out to the right ①.

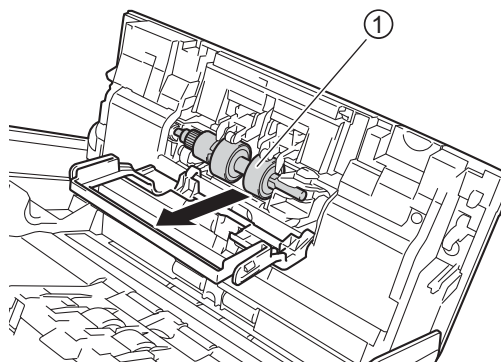

- Slide the new Reverse Roller ① into the opening on the left and place it into the machine.

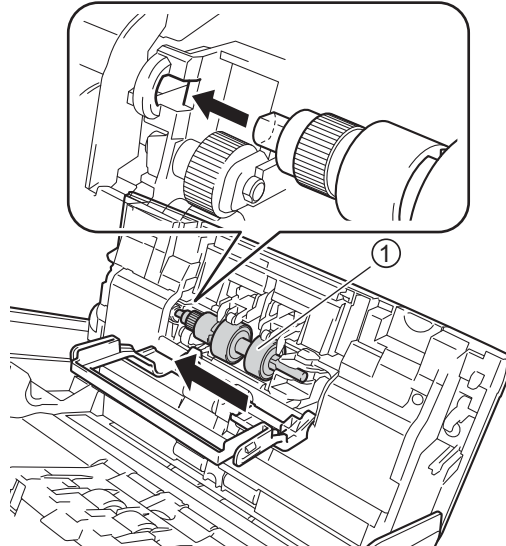

- Close the Reverse Roller Cover.
- Close the Front Cover.
- Reset the Reverse Roller Counter (see *Reset the Usage Counters* on page 255).

NOTE

Confirm the following:

- The value of the Reverse Roller Count is 0 (see *Check Supplies Replacement Cycle (ADS-2400N / ADS-3000N)* on page 247).
- The error message on the Status Monitor has been cleared.
- The Touchscreen or LED indication does not indicate Replace Reverse Roller.

Reset the Usage Counters

- 1 Start ControlCenter.
 - Windows®
 - a Click the  (ControlCenter4) icon in the task tray and select **Open** from the menu. The **ControlCenter4** window appears.
 - b Click the **Device Settings** tab (the example below uses **Home Mode**).

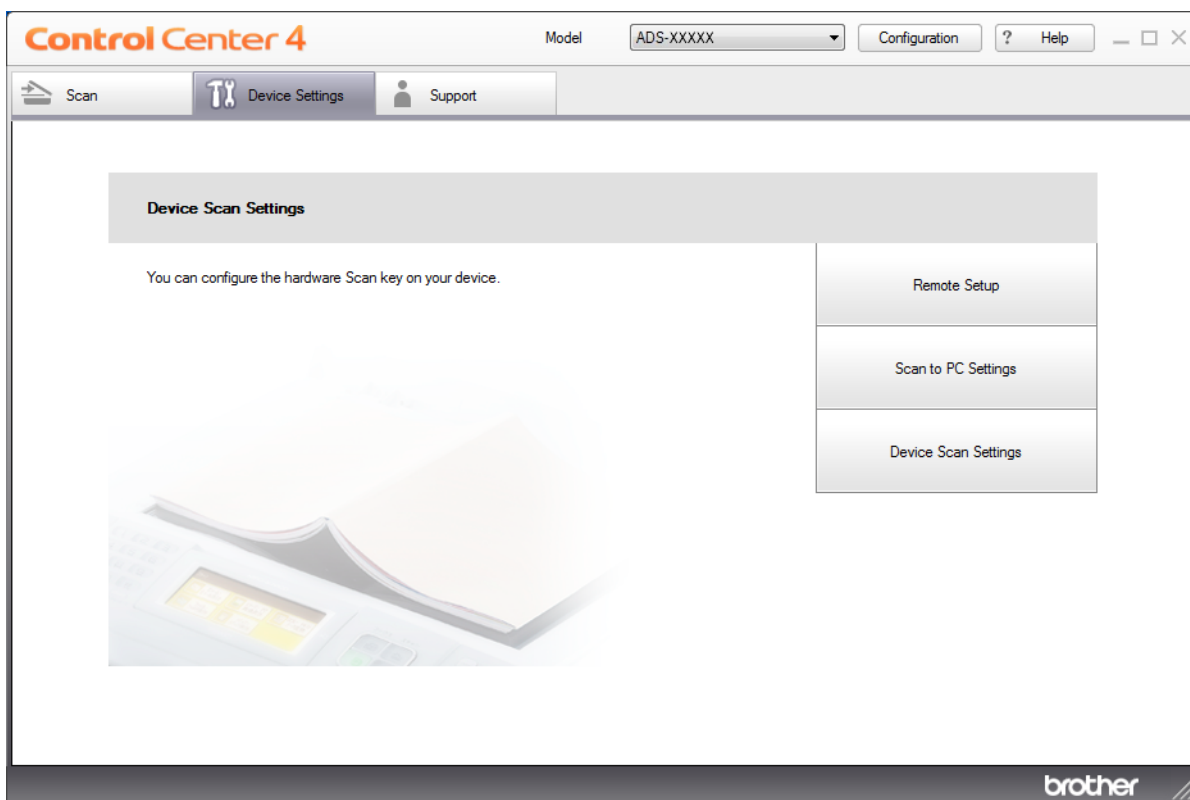

NOTE

If using **Advanced Mode**, click the  (Settings) icon to access **Device Settings**.



■ Macintosh

- a Click the  (ControlCenter2) icon in the Dock. The **ControlCenter2** window appears.
- b Click the **DEVICE SETTINGS** tab.

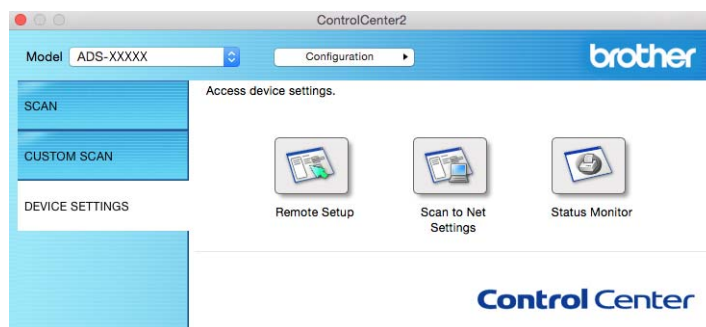

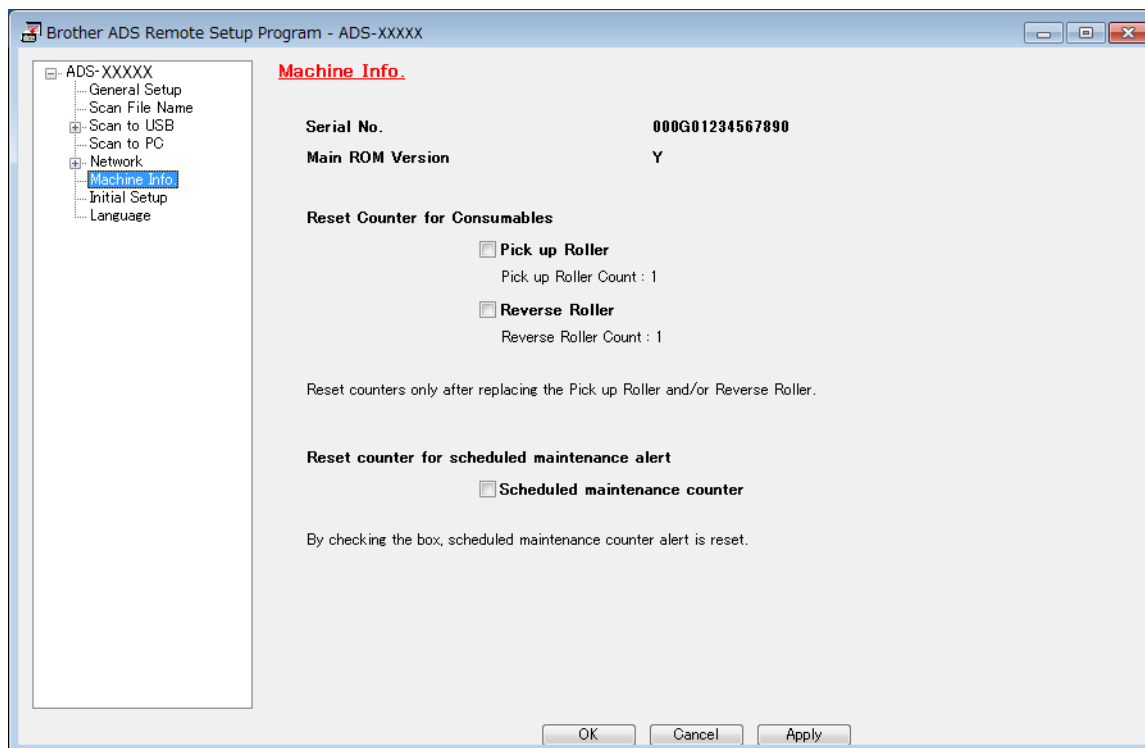

- 2 Click the **Remote Setup** button. The Remote Setup window appears.

- 3 Select **Machine Info.** in the folder tree and configure the scan settings as needed (the example below uses Windows®).



- 4 Do one of the following:
 - To reset the Reverse Roller Counter, select the **Reverse Roller** check box.
 - To reset the Pick Up Roller Counter, select the **Pick up Roller** check box.
- 5 Click **Apply**.
- 6 Click **OK**.

Reset the Usage Counters (ADS-2800W / ADS-3600W)

- 1 Press  (Settings).
- 2 Press ▲ or ▼ to display Machine Info.
- 3 Press Machine Info.
- 4 Press Usage Counter.
- 5 Do one of the following:
 - To reset the Reverse Roller Counter, press Reverse Roller.
 - To reset the Pick Up Roller Counter, press Pick up roller Count.
- 6 When the Touchscreen displays a confirmation message, press Yes.
- 7 Press .

Packing and Shipping the Machine

When you transport the machine, use the packing materials that came with your machine. If you do not pack the machine correctly, any damage that may occur in transit may not be covered by your warranty. The machine should be adequately insured with the carrier.

- 1 Firmly collapse the Extendable ADF.
- 2 Remove the Extendable ADF ① while releasing the levers on the back side.

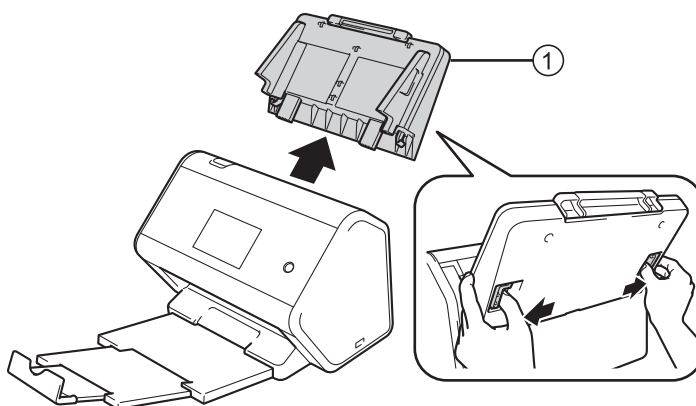

- 3 Firmly push the Output Tray ① into the machine.

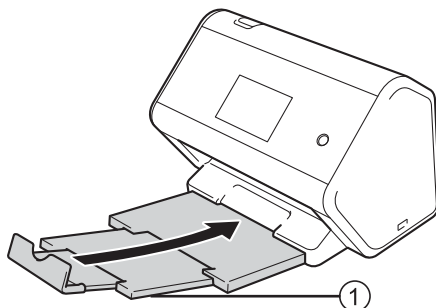

- 4 Wrap the machine in the original bag.

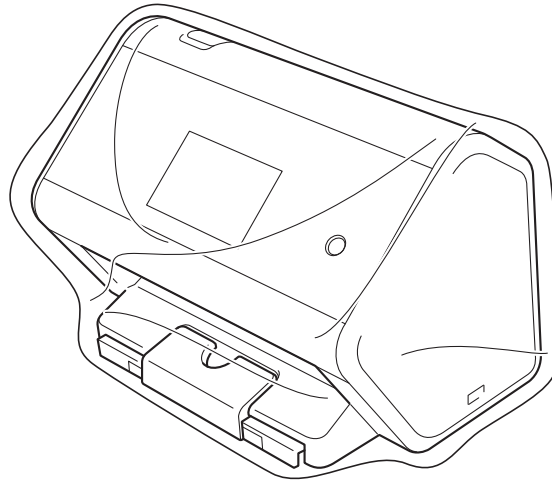

- 5 Pack the machine and the printed materials in the original carton with the original packing material as shown below.

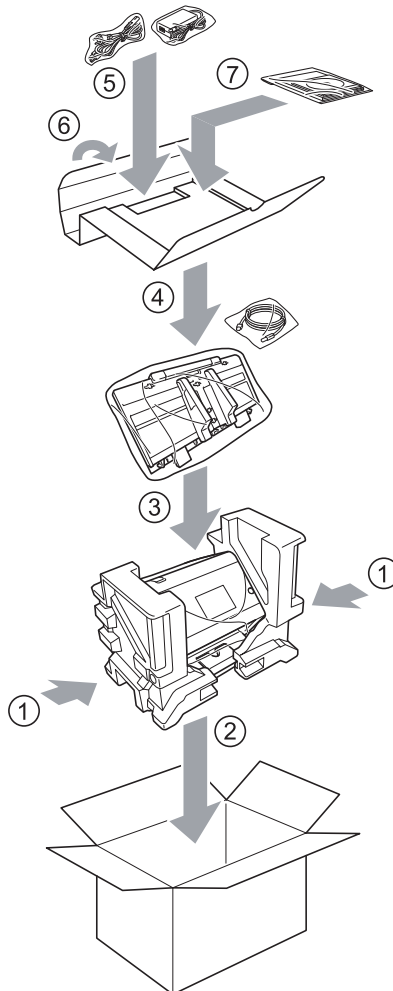

NOTE

If you are returning your machine to Brother as part of the Exchange Service, pack only the machine. Keep all separate parts (power cord, Carrier Sheet and USB cable) and printed materials to use with your “Exchange” machine.

- 6 Close the carton and tape it shut.

Overview

This chapter explains how to resolve typical network problems you may encounter when using your Brother machine.

Go to your model's **Manuals** page on the Brother Solutions Center at support.brother.com to download the other manuals.

Identifying Your Problem

First, check the following:

- The AC power cord is connected properly and the machine is turned on.
- All of the protective parts have been removed.
- The Front Cover, Reverse Roller Cover and Pick Up Roller Cover are completely closed.
- The interface cable is securely connected to the machine and the computer.
- The correct driver for the machine has been installed.
- The computer is connected to the correct port on the machine.

Error and Maintenance Messages

(For ADS-2800W / ADS-3600W)

As with any sophisticated office product, errors may occur and supplies must be replaced. If this happens, your machine identifies the error or required routine maintenance and displays the appropriate message. The most common error and maintenance messages are shown in the table.

You can correct most errors and clear routine maintenance messages yourself. If you need more help, the Brother Solutions Center offers the latest FAQs and troubleshooting tips.

Visit support.brother.com

NOTE





(For ADS-2400N and ADS-3000N)

See also *LED Indications (ADS-2400N / ADS-3000N)* on page 286.

If the Touchscreen displays errors and your Android™ device supports the NFC feature, touch your device to the NFC logo on the right side of the control panel to access the Brother Solutions Center and browse the latest FAQs from your device. (Your mobile telephone provider's message and data rates may apply to your use of this function.)

Make sure your machine's NFC setting and your Android™ device are set to On.

Error message	Cause	Action
Check Connection	The machine is not connected to your computer.	Connect the machine to your computer, and then try again.
Out of Memory	The machine's memory is full.	<p>To clear the error, do one of the following:</p> <ul style="list-style-type: none"> ■ Press any button (ADS-2400N / ADS-3000N) or  (ADS-2800W / ADS-3600W). ■ Turn the machine off and then on by unplugging the machine from the AC power outlet and then plugging the machine in again. <p>To prevent the error, do one of the following:</p> <ul style="list-style-type: none"> ■ Reduce the number of your documents. ■ Set resolution setting or file size smaller.
This machine is not connected to your PC	The machine is not connected to your computer.	Connect the machine to your computer, and then try again.
Replace Pick up roller	The Pick Up Roller has been used over 200,000 times.	Replace the Pick Up Roller with a new one. Scanning errors may occur if you do not replace the part. See <i>Replace the Pick Up Roller</i> on page 250.
Replace Reverse Roller	The Reverse Roller has been used over 200,000 times.	Replace the Reverse Roller with a new one. Scanning errors may occur if you do not replace the part. See <i>Replace the Reverse Roller</i> on page 253.
Replace pick up and reverse roller	Both the Reverse Roller and the Pick Up Roller have been used over 200,000 times.	Replace the Reverse Roller and the Pick Up Roller with new ones. Scanning errors may occur if you do not replace the parts. See <i>Replace the Pick Up Roller</i> on page 250 and <i>Replace the Reverse Roller</i> on page 253.
Unable to Scan XX (XX is an error code.)	A machine error has occurred.	Turn the machine off and then on, and then try to scan again. If the error is not cleared after turning the machine off and then on, make a note of the error message and report it to your Brother dealer or Brother Customer Service (see <i>For Customer Service</i> on page ii).
Scan error due to length, reduce length	Documents that exceed the maximum length was scanned.	Decrease the scanner resolution because the maximum length that can be scanned varies depending on the resolution.

Error message	Cause	Action
Document Jam/ Too long	<ul style="list-style-type: none"> ■ The Paper Guides are not set to the correct document size. ■ The settings are not suitable for your document. ■ Paper dust has accumulated on the surface of the Pick Up Roller or Reverse Roller. 	<p>Clear the document jam (see <i>Document Jam</i> on page 266) and then do the following:</p> <ul style="list-style-type: none"> ■ Adjust the Paper Guides to fit the width of the document. When Scan Size is set to Auto and you are scanning a document that contains multiple page sizes, insert narrow pages straight and as close to the center of the machine as possible. If the document does not feed straight, use Continuous Scanning. ■ Confirm the settings. See <i>Important in Document Jam</i> on page 266. ■ Clean the Pick Up Roller and Reverse Roller. See <i>Clean the Scanner and Rollers</i> on page 241.
Multifeed detection	Multiple pages were fed at the same time.	Clear the Multifeed. See <i>Document Jam</i> on page 266.
Unusable Device	An unusable device is inserted in the USB port.	Disconnect the device. Turn the machine off and then on by unplugging the machine from the AC power outlet and then plugging the machine in again.
Unusable USB Device	An unsupported USB device is inserted in the USB port.	Remove the unsupported USB device, such as a mouse or mobile device that does not support USB flash drive mode, from the USB port.
USB Hub Not Supported	A hub or USB flash drive with a hub is inserted in the USB port.	Remove the unsupported device, such as a USB hub or USB flash drive with a hub, from the USB port.
Insufficient USB Storage	The inserted USB flash drive is full.	<p>Press any button (ADS-2400N / ADS-3000N) or  (ADS-2800W / ADS-3600W) and then do one of the following:</p> <ul style="list-style-type: none"> ■ Delete unused files or folders from the USB flash drive and then try again. ■ Use a USB flash drive that has available space.
USB Access Error	The USB flash drive was removed while it was being accessed.	<p>Press any button (ADS-2400N / ADS-3000N) or  (ADS-2800W / ADS-3600W).</p>
USB Write-protected	The inserted USB flash drive is write-protected.	<p>Remove the write-protected USB flash drive, press any button (ADS-2400N / ADS-3000N) or  (ADS-2800W / ADS-3600W), and then do one of the following:</p> <ul style="list-style-type: none"> ■ Turn off the USB flash drive's write-protection and then try again. ■ Use a USB flash drive that is not write-protected.
Too Many Files on USB	Your machine cannot save to a USB flash drive if it contains too many files.	<p>Remove the USB flash drive, press any button (ADS-2400N / ADS-3000N) or  (ADS-2800W / ADS-3600W). Delete unused files or folders from the root folder of the USB flash drive and then try again.</p>

Error message	Cause	Action
File Name Cannot Be Used	The maximum sequential number 99 sequential number for the file name has been reached.	Press any button (see <i>File Name Cannot Be Used (Scan to USB)</i> on page 290) (ADS-2400N / ADS-3000N) or  (ADS-2800W / ADS-3600W) and then do one of the following: <ul style="list-style-type: none"> ■ Delete unused files from the USB flash drive and then try again. ■ Change the file name. See <i>Save Scanned Documents on a USB Flash Drive</i> on page 158.
No Profile set	No Scan to FTP/SFTP profile or Scan to Network profile is registered.	Configure the Scan to FTP/SFTP profile or the Scan to Network profile before using Scan to FTP or Scan to Network. See <i>Scan Documents to an FTP Server</i> on page 164, <i>Scan Documents to an SFTP Server</i> on page 174 or <i>Scan Documents to a Shared Folder / Network Location (Windows®)</i> on page 184.
No Certificate	The certificate does not exist, or is corrupted.	Configure the settings under Signed PDF in the Administrator tab in Web Based Management. See <i>Scan Documents to an FTP Server</i> on page 164 or <i>Scan Documents to a Shared Folder / Network Location (Windows®)</i> on page 184.
Address Book Full	The Address Book is full.	Delete unnecessary email addresses, and then try again.
Registration Failed	(Email Address) The email address is too long.	You can enter an email address that contains up to 64 characters.
	(Shortcut) The maximum number of email addresses in a shortcut has been reached.	Delete unnecessary email addresses, and then try again.
Shortcuts Full	The maximum number of shortcuts has been reached.	Delete unnecessary shortcuts, and then try again.
Cannot Delete	The email address is registered in a shortcut.	You cannot delete an email address used in a shortcut. Delete the shortcut first, and then try again.
Access Denied	Secure Function Lock is On.	Call your administrator to check your Secure Function Lock settings. See <i>Secure Function Lock 3.0</i> on page 41.
Scheduled Maintenance alert	Periodic maintenance is required.	Clean the Pick Up Roller and Reverse Roller and clear the counter. See <i>Clean the Scanner and Rollers</i> on page 241.

Document Jam

Documents can jam in the ADF unit if they are not inserted or fed correctly, if they are too long, or if multiple pages were fed at the same time (multifeed). Follow the steps below to clear a document jam.

- 1 Take out any paper from the ADF that is not jammed.
- 2 Open the Front Cover by pressing the Cover Release Lever ①.

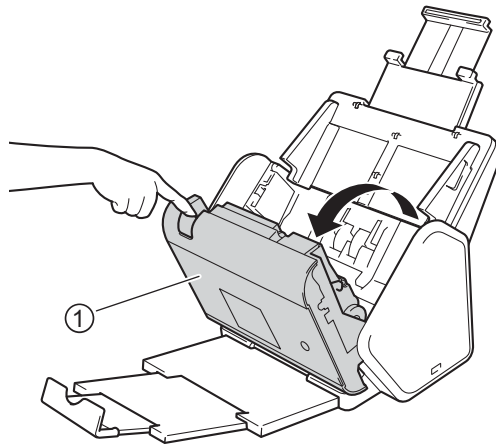

- 3 Pull the jammed document out of the machine.

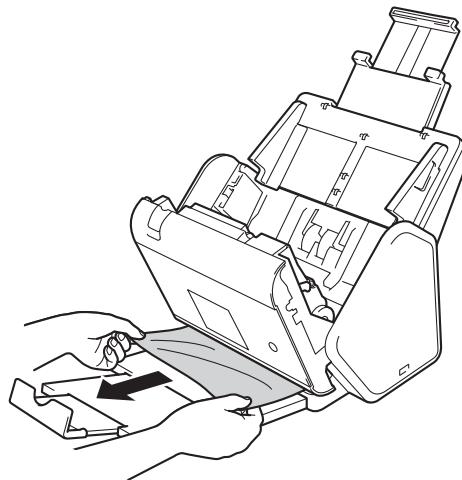

NOTE

Check for ripped paper inside the machine. Remove any paper scraps you find inside the machine.

- 4 Close the Front Cover.

- 5 Press any button (ADS-2400N / ADS-3000N) or  (ADS-2800W / ADS-3600W).

NOTE

When clearing the multifeed, confirm that the data scanned before the multifeed was detected has been saved, and then start scanning again at the next page or the beginning of the document.

IMPORTANT

- To avoid damage to the jammed document, DO NOT pull the document out before opening the Front Cover.
- Take out any paper from the ADF before closing the Front Cover.
- To avoid future document jams, do the following:
 - Close the Front Cover properly by pushing it gently in the center.
 - Configure the settings for your document correctly.
 - Clean the Reverse Roller and Pick Up Roller. To clean the Reverse Roller, see *Replace the Pick Up Roller* on page 250 for instructions on how to pull the Reverse Roller out from the machine. Clean the rubber side of the Reverse Roller with a soft lint-free cloth moistened with water, and then put the Reverse Roller back into the machine. To clean the Pick Up Roller, see *Clean the Scanner and Rollers* on page 241.
 - Stagger the pages and then load your document. See *Load Documents* on page 60.
 - Make sure your document is acceptable for the machine. See *Acceptable Documents* on page 51.
 - Load your document properly. See *Load Documents* on page 60.
 - Load no more than 50 pages at a time.
 - To avoid a long paper jam, you must select **Long Paper** for **Scan Size** or **Document Size**.

■ When you scan from your PC

- See *Change Scan Settings (ControlCenter4) (Windows®)* on page 100
- See *Change Scan Settings (ControlCenter2) (Macintosh)* on page 120

■ When you scan from the machine (ADS-2800W / ADS-3600W)

Confirm the following settings on the Touchscreen:

(Scan to USB/FTP/Network/email Server)

- Scan Type: Color **OR** Black & White
- Skip Blank Page: Off

Operational and Software Difficulties

IMPORTANT

For technical help, you must contact Brother customer support.

If you think there is a problem with your machine, check the chart below and follow the troubleshooting tips. You can correct most problems yourself. If you need additional help, the Brother Solutions Center offers the latest FAQs and troubleshooting tips, visit support.brother.com

Using non-Brother supplies may affect the scan quality, hardware performance, and machine reliability.

Scanning Difficulties



Difficulty	Cause	Suggestions
<p>TWAIN or WIA errors appear when starting to scan. (Windows®)</p>	<p>TWAIN or WIA driver has not been chosen as the primary source in your scanning application.</p>	<p>Make sure the Brother TWAIN or WIA driver is chosen as the primary source in your scanning application. For example, in Nuance™ PaperPort™ 14SE, click Scan Settings and then Select to select the Brother TWAIN/WIA driver.</p>
<p>TWAIN errors appear when starting to scan. (Macintosh)</p>	<p>The TWAIN driver has not been chosen as the primary source in your scanning application.</p>	<p>Make sure the Brother TWAIN driver is chosen as the primary source in your application. You can also scan documents using the ICA Scanner Driver.</p>
<p>OCR does not work.</p>	<p>The scanner resolution is too low.</p>	<p>Increase the scanner resolution.</p>
<p>Vertical lines are seen in the scanned image.</p>	<p>Paper dust has accumulated on the surface of the glass strips.</p>	<p>Clean the glass strips inside the machine. See <i>Clean the Scanner and Rollers</i> on page 241.</p>
<p>The scanned image is missing.</p>	<ul style="list-style-type: none"> ■ The Paper Guides are not adjusted to fit the width of the document. ■ The Auto Deskew feature was set to On when the document was scanned. ■ The settings are not suitable for your document. For example, a Legal Letter/A4 size document was fed when Executive/A5 Letter was selected as document size. 	<ul style="list-style-type: none"> ■ Adjust the Paper Guides to fit the width of the document. When Scan Size is set to Auto and you are scanning a document that contains multiple page sizes, insert narrow pages straight and as close to the center of the machine as possible. If the document does not stay straight while feeding, use Continuous Scanning. ■ Set Auto Deskew to Off. ■ Make sure the document size settings are suitable for your document. <p>Configure the margin settings and adjust the scanning position. For more information, see <i>Adjust the Scanning Position</i> on page 227.</p>





Difficulty	Cause	Suggestions
The scanned image is skewed.	<ul style="list-style-type: none"> ■ The Paper Guides are not adjusted to fit the width of the document. ■ The Auto Deskew feature was set to Off when the document was scanned. ■ The Long Paper setting is selected. 	<ul style="list-style-type: none"> ■ Adjust the Paper Guides to fit the width of the document. When Scan Size is set to Auto and you are scanning a document that contains multiple page sizes, insert narrow pages straight and as close to the center of the machine as possible. If the document does not stay straight while feeding, use Continuous Scanning. ■ Set Auto Deskew to On. ■ Set other than Long paper.
Scanning is too slow.	The resolution is not suitable for your document.	Decrease the scanner resolution. Set scan size to a setting other than Auto.
The document was not fed.	<ul style="list-style-type: none"> ■ Paper dust has accumulated on the surface of the Pick Up Roller or Reverse Roller. ■ Too many documents are loaded in the ADF at a time. ■ There are foreign objects in the ADF. ■ Your document is too thin or too thick. ■ Remote Setup is in process. ■ Paper ejection has paused. ■ The Reverse Roller Cover is not properly closed. 	<ul style="list-style-type: none"> ■ Clean the Reverse Roller and Pick Up Roller. To clean the Reverse Roller, see <i>Replace the Pick Up Roller</i> on page 250 for how to pull the Reverse Roller out of the machine, clean the rubber side of the Reverse Roller with a soft lint-free cloth moistened with water, and then attach the Reverse Roller in the machine. To clean the Pick Up Roller, see <i>Clean the Scanner and Rollers</i> on page 241. ■ Make sure the maximum number of pages is suitable for your document. See <i>Acceptable Documents</i> on page 51. ■ Remove any foreign objects or ripped paper from the ADF. ■ Make sure your document is acceptable for the machine. See <i>Acceptable Documents</i> on page 51. ■ Cancel Remote Setup. ■ Remove any paper from the ADF. ■ Securely close the Reverse Roller Cover until the hooks fit into the Front Cover.
The document is jammed.	<ul style="list-style-type: none"> ■ Paper dust has accumulated on the surface of the Pick Up Roller or Reverse Roller. ■ There are foreign objects in the ADF. ■ Your document is not acceptable for the machine. 	<ul style="list-style-type: none"> ■ Clean the Reverse Roller and Pick Up Roller. To clean the Reverse Roller, see <i>Replace the Pick Up Roller</i> on page 250 for how to pull the Reverse Roller out of the machine, clean the rubber side of the Reverse Roller with a soft lint-free cloth moistened with water, and then attach the Reverse Roller in the machine. To clean the Pick Up Roller, see <i>Clean the Scanner and Rollers</i> on page 241. ■ Remove any foreign objects or ripped paper from the ADF. ■ Make sure your document is acceptable for the machine. See <i>Acceptable Documents</i> on page 51.

Difficulty	Cause	Suggestions
The order of the output document pages will change.	The Output Tray has been positioned so that it does not match the size of the document.	Carefully position the Output Tray so that it matches the size of the document.
The scan quality is poor.	<ul style="list-style-type: none"> ■ Paper dust has accumulated on the surface of the Pick Up Roller or Reverse Roller. ■ Paper dust has accumulated on the surface of the glass strips inside the machine. ■ The resolution is too low. 	<ul style="list-style-type: none"> ■ Clean the Reverse Roller and Pick Up Roller. To clean the Reverse Roller, see <i>Replace the Pick Up Roller</i> on page 250 for how to pull the Reverse Roller out of the machine, clean the rubber side of the Reverse Roller with a soft lint-free cloth moistened with water, and then attach the Reverse Roller in the machine. To clean the Pick Up Roller, see <i>Clean the Scanner and Rollers</i> on page 241. ■ Clean the glass strips inside the machine. See <i>Clean the Scanner and Rollers</i> on page 241. ■ Increase the scanner resolution.
The machine pauses for about 3 seconds between each page when scanning.	<p>The machine has entered Motor Save mode. If you scan continuously, the internal temperature of the machine may increase, causing the machine to enter Motor Save mode.</p> <p>NOTE</p> <p>The length of the pause may vary depending on the scanning conditions.</p>	This is normal and you may continue to scan. If you scan continuously, the internal temperature of the machine may increase, causing the machine to enter Motor Save mode.
Bleed through is seen in the scanned data.	The settings are not appropriate for the type of document being scanned.	Select the Remove Bleed-through / Pattern / Remove Background Color check box.
Colors in the scanned data are dark.	The settings are not appropriate for the type of document being scanned.	<p>Do one of the following:</p> <ul style="list-style-type: none"> ■ Select the Remove Bleed-through / Pattern / Remove Background Color check box and then scan from your computer. ■ Change Brightness higher and then scan from your computer. ■ Change Contrast higher and then scan from your computer. ■ Change Scan Type to Gray or Color and then scan from your computer.
A page that is not a blank page is skipped.	<ul style="list-style-type: none"> ■ The document is too light. ■ Skip Blank Page is set to On. 	Set Skip Blank Page to Off. Alternatively, adjust the Skip Blank Page sensitivity so that it is lower.

Difficulty	Cause	Suggestions
Cannot scan a long document.	Long Paper is not selected for the document size.	Select Long Paper for the document size. If you cannot select Long Paper, when scanning from the machine's Control Panel, set Skip Blank Page to Off and set Scan Type to an option other than Auto. Then, you can select Long Paper for the document size.
A multifeed occurs.	The document is not loaded properly.	Load your document properly (see <i>Standard-size Documents</i> on page 60), and then try again.
Cannot scan.	Secure Function Lock is on.	Call your administrator to check your Secure Function Lock settings. See <i>Secure Function Lock 3.0</i> on page 41.
Cannot scan a thick card successfully.	Card materials and environment are not suitable.	Load your card sideways. Scan using the following settings: Plastic card mode: Off Resolution: 600 dpi Document Size: Auto Multifeed detection: Off
Rear end scan result expires when you scan a thick document or the scanned image will be stretched.	A thick document hit the output tray.	Scan your document without using the output tray.

Software Difficulties



Difficulty	Cause	Suggestions
Cannot install software.	—	(Windows® users only) Run the Repair MFL-Pro Suite program on the DVD-ROM. This program will repair and reinstall the software.
Cannot find how to start ControlCenter4 (Windows®).	—	If the  icon is not displayed in the task tray, click  (Brother Utilities) on your desktop, and then click the drop-down list and select your model name (if not already selected). Click Scan in the left navigation bar, and then click ControlCenter4 .
Cannot start ControlCenter2 (Macintosh).	You have not logged on the computer as the administrator.	Restart the computer and log on as the administrator.

Difficulty	Cause	Suggestions
Cannot find how to start ControlCenter2 (Macintosh).	—	To start ControlCenter2, click the  (ControlCenter2) icon in the Dock. If the  (ControlCenter2) icon is not displayed in the Dock, in the Finder menu bar, click Go > Applications > Brother , and then double-click the  (ControlCenter2) icon. The  (ControlCenter2) icon appears in the Dock.
Cannot find how to configure the settings to scan from the Control Panel of the machine. (ADS-2400N / ADS-3000N)	—	Use Remote Setup. See <i>Set Up the Brother Machine from Your Computer</i> on page 235.
Cannot save the settings in Remote Setup or Web Based Management.	<ul style="list-style-type: none"> ■ The machine is processing. ■ The machine is being configured from the machine's Control Panel. 	<ul style="list-style-type: none"> ■ Wait until the machine finishes processing and then try again. ■ Stop configuring the machine from the Control Panel.
Cannot start Remote Setup.	<ul style="list-style-type: none"> ■ The machine is turned off. ■ The machine is not connected to your computer. ■ An error is occurring. ■ The machine is scanning. ■ The machine is being configured from the machine's Control Panel. 	<ul style="list-style-type: none"> ■ Turn on the machine, and then try again. ■ Connect the machine to your computer, and then try again. ■ Clear all errors, and then try again. ■ Wait until scanning has finished and try again. ■ Stop configuring the machine from the Control Panel.

Network Difficulties

Difficulty	Suggestions
Cannot scan over the network.	<p>Make sure that your machine is powered on and is online and in Ready Mode. Check the current network settings.</p> <p>See <i>Troubleshooting</i> in the <i>Network User's Guide</i>.</p>
The network scanning feature does not work.	<p>(Windows® users)</p> <p>It is necessary to configure the third-party Security/Firewall Software to allow Network scanning. To add port 54925 for Network scanning, enter the information below:</p> <p>In Name: Enter any description, for example Brother NetScan.</p> <p>In Port number: Enter 54925.</p> <p>In Protocol: UDP is selected.</p> <p>Refer to the instruction manual that came with your third-party Security/Firewall Software or contact the software manufacturer.</p> <p>(Macintosh users)</p> <p>Re-select your machine in the Device Selector application from the model list in ControlCenter2.</p>
The Brother software cannot be installed.	<p>(Windows® users)</p> <p>If the Security Software warning appears on the computer screen during the installation, change the Security Software settings to permit the Brother product setup program or other program to run.</p> <p>(Macintosh users)</p> <p>If you are using a firewall function of anti-spyware or antivirus security software, temporarily disable it, and then install the Brother software.</p>
Cannot connect to wireless network. (ADS-2800W / ADS-3600W)	<p>Check the wireless network settings.</p> <p>See <i>Troubleshooting</i> in the <i>Network User's Guide</i>.</p>
Reset the network settings.	<p>See <i>Reset the Machine (ADS-2400N / ADS-3000N)</i> on page 278.</p> <p>See <i>Reset the Machine (ADS-2800W / ADS-3600W)</i> on page 279.</p>
How to check the machine's IP address. (ADS-2400N / ADS-3000N)	<p>(ADS-2400N / ADS-3000N)</p> <ol style="list-style-type: none"> 1 Start the ControlCenter application. 2 Click the Device Settings tab. 3 Click the Scan to Net Settings button. The Web Based Management window appears. 4 Select Network tab. 5 Click Wired.
Cannot recognize the NFC card.	Set NFC to On .

Other Difficulties

Difficulty	Cause	Suggestions
The machine is in Sleep Time (power save mode). (ADS-2800W / ADS-3600W)	The machine is idle and the amount of time specified by the Sleep Time setting has elapsed.	Do one of the following: <ul style="list-style-type: none"> ■ Press . ■ Press . ■ Scan using your computer. ■ Open the Top Cover. ■ Load your document. ■ Touch the screen. ■ Touch IC Card to the NFC reader.
The machine is not turned on.	The machine was plugged in within 60 seconds after pulling out the plug.	Turn off the machine, wait 60 seconds, and then turn on the scanner.
The machine is in Offline Mode.	The machine is not connected to the computer.	Connect the machine to the computer and turn on the machine.

Machine Information

Check the Serial Number (ADS-2400N / ADS-3000N)

- 1 Start the ControlCenter application.
 - Windows®
 - a Click the  (ControlCenter4) icon in the task tray and select **Open** from the menu. The **ControlCenter4** window appears.
 - b Click the **Device Settings** tab (the example below uses **Home Mode**).

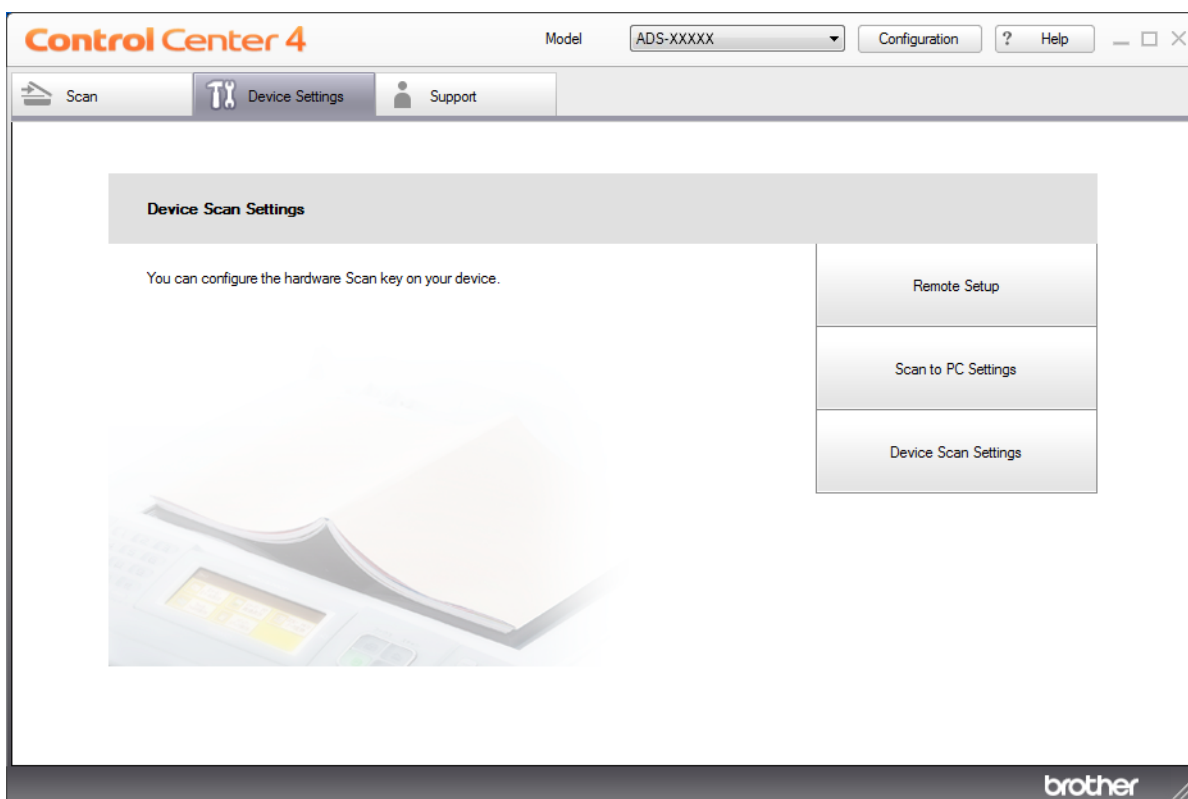

NOTE

If using **Advanced Mode**, click the  (Settings) icon to access **Device Settings**.



■ Macintosh

- a Click the  (ControlCenter2) icon in the Dock. The **ControlCenter2** window appears.
- b Click the **DEVICE SETTINGS** tab.

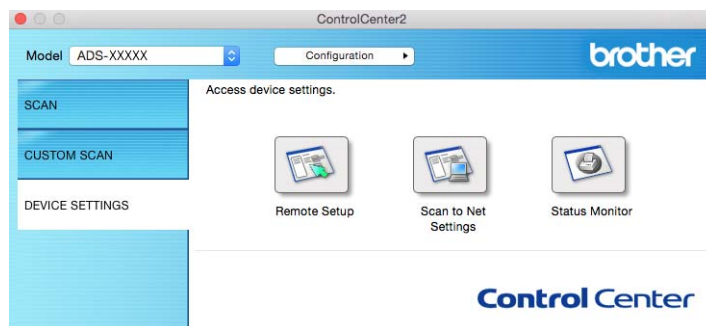

- 2 Click the **Remote Setup** button. The Remote Setup window appears.

- 3 Select **Machine Info.** in the folder tree. The window displays the **Serial No.** (the example below uses Windows®).

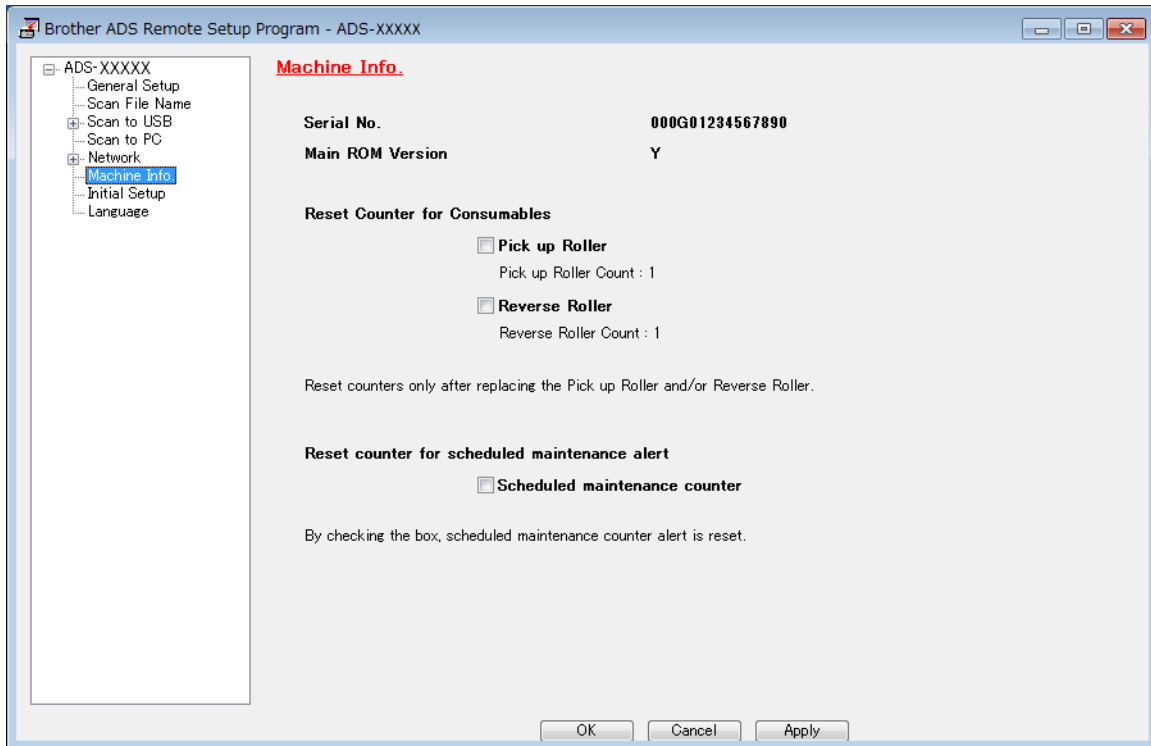

Check the Serial Number (ADS-2800W / ADS-3600W)

- 1 Press  (**Settings**).
- 2 Press **Machine Info.**
- 3 Press **Serial No.** The Touchscreen displays the machine's serial number.

WLAN Enable/Disable (ADS-2800W / ADS-3600W)

- 1 Press  (**Settings**).
- 2 Press **Network.**
- 3 Press **WLAN.**
- 4 Press **▲** or **▼** to display **WLAN Enable.**
- 5 Press **WLAN Enable.**
- 6 Press **On (or Off).**

Reset Functions

The following reset functions are available:

- Network

You can restore the network settings, such as the password and IP address information, to the factory settings.

- Address Book (ADS-2800W / ADS-3600W)

You can reset the Address Book.

- All Settings

You can restore all settings to the factory settings.

We recommend performing this procedure before transferring or disposing of the machine.

NOTE





Unplug the interface cable before you choose **Network** or **All Settings**.

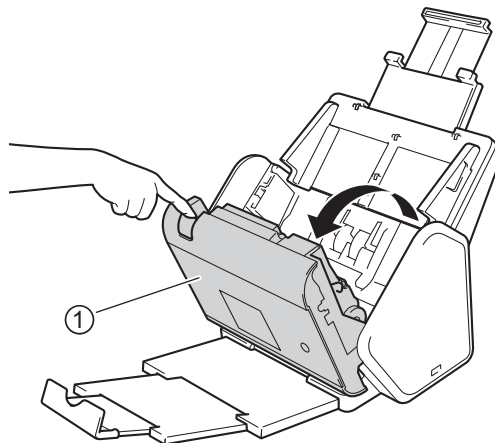

Reset the Machine (ADS-2400N / ADS-3000N)

- 1 Open the Front Cover ①.



- 2 Do one of the following:

- Press  for about five seconds until the machine beeps to reset the network.
- Press  for about five seconds until the machine beeps to reset the IP Sec.
- Press  3 for about five seconds until the machine beeps to reset the Periodic Cleaning Counter.
- Press  2 for about five seconds until the machine beeps to reset the Pick Up Roller Counter.

- Press  1 for about five seconds until the machine beeps to reset the Reverse Roller Counter.
- Press  2  3 for about five seconds until the machine beeps to reset the Pick Up Roller Counter and Reverse Roller Counter.

Reset the Machine (ADS-2800W / ADS-3600W)

- 1 Press  (Settings).
- 2 Press ▲ or ▼ to display Initial Setup.
- 3 Press Initial Setup and then Reset.
- 4 Press the type of reset you want.
- 5 Press Yes to confirm.
- 6 Press Yes for two seconds to restart the machine.

A

Specifications

General

NOTE

This chapter provides a summary of the machine's specifications. For additional specifications, visit www.brother.com for details.

Model		ADS-2400N	ADS-3000N	ADS-2800W	ADS-3600W
Memory Capacity	Standard	256 MB		512 MB	
Power Source	USA	100 - 120 V AC 50/60 Hz			
	Latin American Countries	220 - 240 V AC 50/60 Hz			
Touchscreen LCD (Liquid Crystal Display)		-		Touchscreen 3.7 in. (93.4 mm) TFT Color LCD ¹	
Approx. Power Consumption ²	Scanning ³	27 W	30 W	27 W	30 W
	Ready ⁴	3.0 W	4.1 W	3.7 W	4.9 W
	Sleep	1.9 W	2.9 W	1.9 W	2.9 W
	Power Down	0.12 W			

¹ Measured diagonally.

² Measured when the machine is connected to your computer.

³ When using 2-sided (duplex) scanning.

⁴ When all network ports are activated and connected.

Model		ADS-2400N	ADS-3000N	ADS-2800W	ADS-3600W
Dimensions		<p>The technical drawings show the following dimensions:</p> <ul style="list-style-type: none"> Front View (Top): Height is 9.8 in (250 mm), width is 12.0 in (306 mm). Side View (Top): Depth is 7.2 in (182 mm), total width is 10.2 in (258 mm). Rear View (Top): Total height is 14.0 in (356 mm), main body height is 7.8 in (199 mm), width is 12.0 in (306 mm). Side View (Bottom): Depth is 12.3 in (313 mm), total width is 26.2 in (665 mm), and a secondary depth is 13.9 in (352 mm). 			
Approx. Weights		9.8 lb (4.45 kg) (ADS-2400N / ADS-3000N)		10 lb (4.55 kg) (ADS-2800W / ADS-3600W)	
Temperature	Operating	41 to 95 °F (5 to 35 °C)			
	Storage	32 to 104 °F (0 to 40 °C)			

A

Model		ADS-2400N	ADS-3000N	ADS-2800W	ADS-3600W
Humidity		Operating	20 to 80%		
		Storage	10 to 90%		
ADF (automatic document feeder)		Up to 50 pages (Paper: 20 lb (80 g/m ²) Legal size, or less than 0.2 in. (5 mm))			
Document Size	Multiple Paper	Width	2.0 to 8.5 in. (51 to 215.9 mm)		
		Length	2.0 to 14.0 in. (51 to 355.6 mm)		
	Single Paper	Width	2.0 to 8.5 in. (51 to 215.9 mm)		
		Length	2.0 to 196.9 in. (51 to 5,000 mm)		

Scanner

Color/Black		Yes / Yes
TWAIN Compliant	Windows [®]	Windows [®] XP Home (SP2 or later) / Windows [®] XP Professional (SP2 or later, x32 only) / Windows Vista [®] / Windows Server [®] 2003 (only 32 bit) / Windows Server [®] 2008 / Windows Server [®] 2008 R2 / Windows Server [®] 2012 / Windows Server [®] 2012 R2 / Windows [®] 7 / Windows [®] 8 / Windows [®] 8.1
	Macintosh	OS X 10.8.5, 10.9.x, 10.10.x ¹
WIA Compliant	Windows [®]	Windows [®] XP / Windows Vista [®] / Windows [®] 7 / Windows [®] 8 / Windows [®] 8.1
ICA Compliant	Macintosh	OS X 10.8.5, 10.9.x, 10.10.x ¹
ISIS™ Compliant	Windows [®]	Windows Vista [®] / Windows [®] 7 / Windows [®] 8 / Windows [®] 8.1
Color Depth	Input	30 bit color Processing
	Output	24 bit color Processing
Resolution	Interpolated	Up to 1,200 × 1,200 dpi
	Optical	Up to 600 × 600 dpi
Scanning Width		Up to 8.5 in. (215 mm)
Greyscale		256 levels
Max. Speed		For detailed specifications, visit www.brother.com

¹ For the latest driver updates for the OS X you are using, visit support.brother.com

Direct Scan Feature (Scan to USB)

Compatible Media	USB flash drive 1 ¹
Interface	Interface USB 2.0 Hi Speed

¹ USB Mass Storage standard up to 64 GB
Support format: FAT12/FAT16/FAT32/exFAT.

Interfaces

USB	(ADS-2400N / ADS-2800W) Hi-Speed USB 2.0 ^{1, 3} Use a USB 2.0 cable (Type A/B) that is no more than 6 feet (2.0 meters) long. (ADS-3000N / ADS-3600W) USB 3.0 SuperSpeed Port ^{1, 2}
LAN ⁴	Use an Ethernet UTP cable category 6 or higher.
Wireless LAN (ADS-2800W / ADS-3600W)	IEEE 802.11b/g/n (Infrastructure/Ad-hoc Mode) IEEE 802.11g/n (WiFi Direct)

¹ Your machine has a Hi-Speed USB 2.0 interface. The machine can also be connected to a computer that has a USB 1.0/1.1 interface.

² Your machine has a USB 3.0 SuperSpeed interface. The machine can also be connected to a computer that has a USB 2.0/USB 1.1/USB 1.0 interface.

³ Third party USB ports are not supported.

⁴ See *Network* on page 283.
See *Supported Protocols and Security Features* in the *Network User's Guide*.

Network

NOTE

For more information about the Network specifications, see the *Network User's Guide*.

LAN	You can connect your machine to a network for Network Scanning and Remote Setup. Also included is Brother BRAdmin Light ¹ Network Management software.	
Wireless Network Security (ADS-2800W / ADS-3600W)	WEP 64/128 bit, WPA-PSK (TKIP/AES), WPA2-PSK (AES), Enterprise WPA/WPA-PSK (AES), EAP, EAP RAST, PEAP, EAP TTLS, EAP TLS	
Setup Support Utility (ADS-2800W / ADS-3600W)	WPS	Yes

¹ If you require more advanced scanner management, use the latest Brother BRAdmin Professional utility version that is available as a download from support.brother.com

Computer Requirements

SUPPORTED OPERATING SYSTEMS AND SOFTWARE FUNCTIONS								
Computer Platform & Operating System Version		Supported PC Software Functions	PC Interface	Processor Minimum Speed	Minimum RAM	Recommended RAM	Hard Disk Space to install	
							For Drivers	For Applications
Windows® Operating System	Windows® XP Home (SP2 or later) ¹	Scanning	USB 10/100/ 1000Base-TX (Ethernet) Wireless ⁴ 802.11b/g/n	Intel® Pentium® II or equivalent	128 MB	256 MB	150 MB	1.0 GB
	Windows® XP Professional (SP2 or later, x32 only) ¹							
	Windows Vista® ¹			Intel® Pentium® 4 or equivalent	512 MB	1 GB	500 MB	1.0 GB
	Windows Server® 2003 (only 32 bit) ^{2, 3} Windows Server® 2008 ² Windows Server® 2008 R2 ² Windows Server® 2012 ² Windows Server® 2012 R2 ² Windows® 7 ¹ Windows® 8 ¹ Windows® 8.1 ¹			64-bit (Intel® 64 or AMD64) supported CPU	1 GB (32 bit) 2 GB (64 bit)	1 GB (32 bit) 2 GB (64 bit)	650 MB	1.0 GB
Macintosh Operating System	OS X 10.8.5 OS X 10.9.x OS X 10.10.x	Scanning	USB ⁵ 10/100/ 1000Base-TX (Ethernet) Wireless ⁴ 802.11b/g/n	Intel® Processor	2 GB	2 GB	80 MB	1.0 GB
Conditions:								
¹ Nuance™ PaperPort™ 14SE supports Windows® XP Home (SP3 or later), Windows® XP Professional (SP3 or later, x32 only), Windows Vista® (SP2 or later), Windows® 7, Windows® 8 and Windows® 8.1. ² • The Desktop Experience Pack is needed. • None of our supplied applications work on these operating systems. ³ Server OS supports Scanner Driver Only. ⁴ ADS-2800W and ADS-3600W. ⁵ Third-party USB ports are not supported.				For the latest driver updates, visit (in USA) www.brother.com (in Canada) www.brother.ca All trademarks, brand and product names are the property of their respective companies.				

B



Appendix

Entering Text (ADS-2800W / ADS-3600W)

When you must enter text into a machine a keyboard appears on the Touchscreen.



NOTE

- To change between lowercase or uppercase, press .
- To toggle between the keyboards (letters, numbers, or symbols), press .



Inserting Spaces



To enter a space, press *Space*. Or, press  to move the cursor.

NOTE

The characters that are available may differ depending on your country.



Making Corrections

If you entered an incorrect character and want to change it, press  to move the cursor to highlight the incorrect character, and then press . Enter the correct character. You can also insert letters by moving the cursor and entering a character.

Press  for each character you want to erase, or press and hold  to erase all the characters.

LED Indications (ADS-2400N / ADS-3000N)

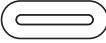
The LED indications on the control panel are explained in the table below.

! or 	The LED is off.
! or 	The LED is on.
! or 	The LED is blinking.

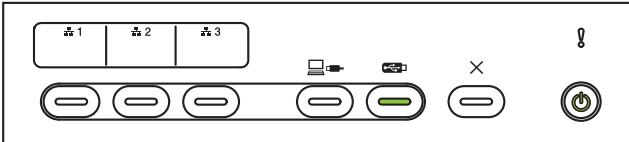
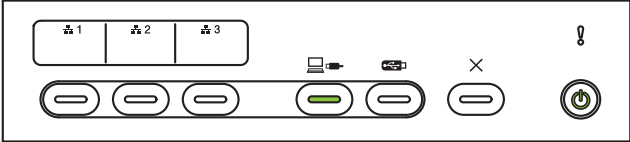
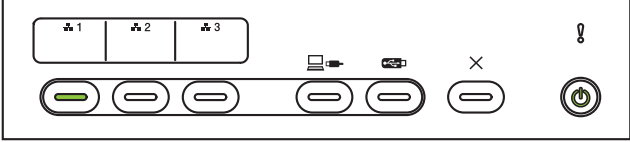
LEDs	Machine Status
	<p>Ready (USB connected)</p> <p>The machine is connected to a USB device and ready to scan.</p>
	<p>Ready (PC connected)</p> <p>The machine is connected to your computer and ready to scan.</p>
	<p>Ready (Net Device 1)</p> <p>The machine is ready to scan to Network Device 1.</p>

B

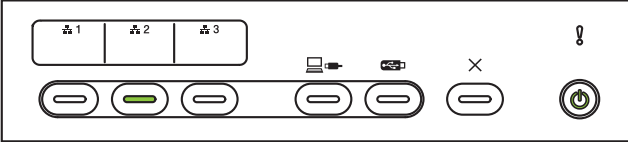
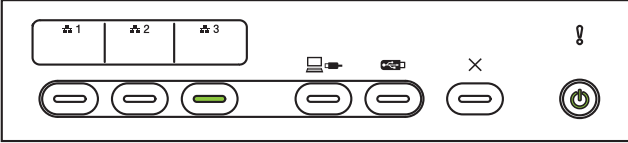
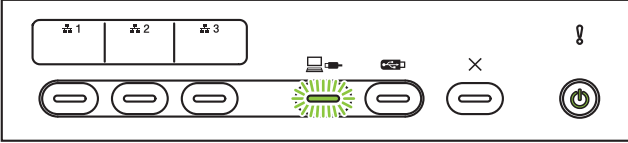
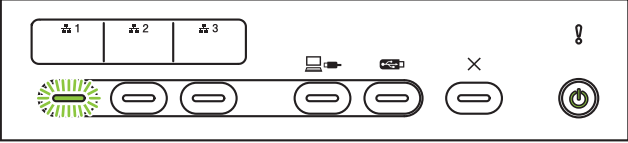
LEDs	Machine Status
	<p>Ready (Net Device 2) The machine is ready to scan to Network Device 2.</p>
	<p>Ready (Net Device 3) The machine is ready to scan to Network Device 3.</p>
	<p>Connecting (Scan to PC) The machine is connecting to the Scan to PC destination.</p>
	<p>Connecting (Scan to Net Device 1) The machine is connecting to Network Device 1 for scanning.</p>

B

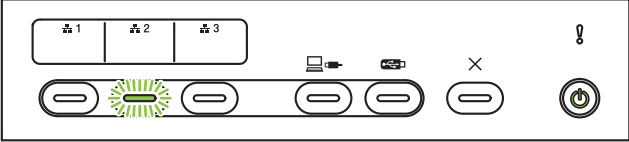
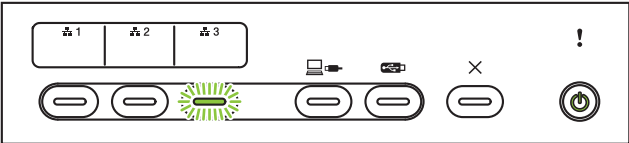
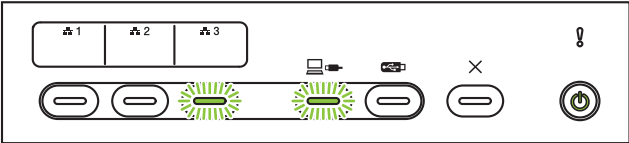
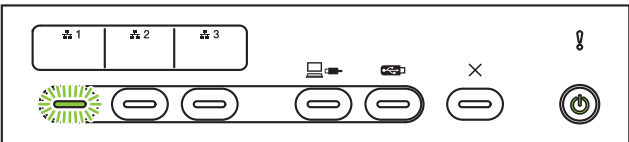
LEDs	Machine Status
	<p>Connecting (Scan to Net Device 2)</p> <p>The machine is connecting to Network Device 2 for scanning.</p>
	<p>Connecting (Scan to Net Device 3)</p> <p>The machine is connecting to Network Device 3 for scanning.</p>
	<p>Scanning (Scan from PC)</p> <p>The machine is scanning from a computer.</p>
	<p>Sending (Scan to Net Device 1)</p> <p>The machine is scanning to Network Device 1.</p>

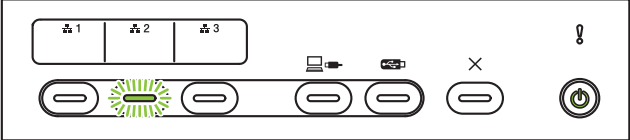
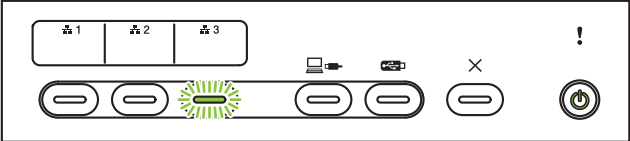
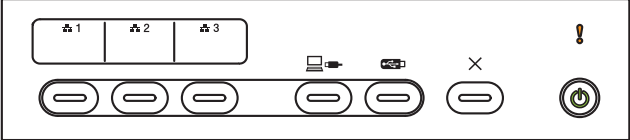
LEDs	Machine Status
	<p>Sending (Scan to Net Device 2)</p> <p>The machine is scanning to Network Device 2.</p>
	<p>Sending (Scan to Net Device 3)</p> <p>The machine is scanning to Network Device 3.</p>
	<p>All Pages Were Skipped</p> <p>All scanned pages were skipped as blank pages. Press any button, and then do the following:</p> <ul style="list-style-type: none"> ■ Place your document, face down, top edge first, in the ADF. ■ Set Blank Page Skip to Off by doing one of the following: <ul style="list-style-type: none"> • See <i>Change Scan Settings (ControlCenter4) (Windows®)</i> on page 100. • See <i>Change Scan Settings (ControlCenter2) (Macintosh)</i> on page 120. • See <i>Change Scan to PC Settings (Windows®)</i> on page 212. • See <i>Change Scan to PC Settings (Macintosh)</i> on page 220. • See <i>Scan Options Using the Touchscreen (ADS-2800W / ADS-3600W)</i> on page 227.

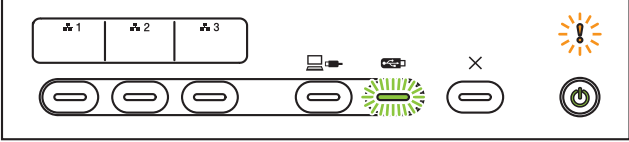
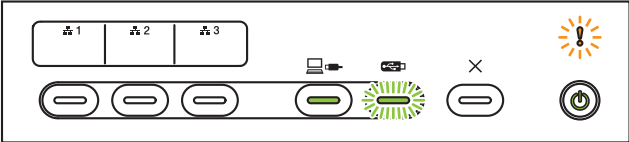
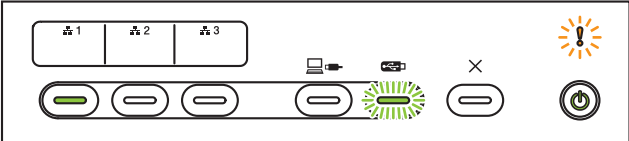
LEDs	Machine Status
 <p>The diagram shows a control panel with three document tray indicators (1, 2, 3), a USB icon, a USB drive icon, a cancel button (X), and a power button. The USB drive icon is highlighted with a green glow, and the power button is lit.</p>	<p>Out of Memory (Scan to USB)</p> <p>The machine's memory is full and the machine cannot scan the entire document.</p> <p>To clear the error, do one of the following:</p> <ul style="list-style-type: none"> ■ Press any button. ■ Unplug the machine from the AC power outlet, and then plug the machine in again. <p>To prevent the error, do one of the following:</p> <ul style="list-style-type: none"> ■ Place fewer pages in the ADF. ■ Set a smaller resolution or file size.
 <p>The diagram shows a control panel with three document tray indicators (1, 2, 3), a USB icon, a USB drive icon, a cancel button (X), and a power button. The USB drive icon is highlighted with a green glow, and the power button is lit.</p>	<p>Too Many Files on USB (Scan to USB)</p> <p>Your machine cannot save to a USB flash drive if it contains too many files. Remove the USB flash drive, press any key, and then do one of the following:</p> <ul style="list-style-type: none"> ■ Delete unused files or folders from the root folder of the USB flash drive, and then try again. ■ Use a USB flash drive that contains fewer than 999 files.
 <p>The diagram shows a control panel with three document tray indicators (1, 2, 3), a USB icon, a USB drive icon, a cancel button (X), and a power button. The USB drive icon is highlighted with a green glow, and the power button is lit.</p>	<p>File Name Cannot Be Used (Scan to USB)</p> <p>The maximum sequential number for the file name has been reached. Press any button, and then do one of the following:</p> <ul style="list-style-type: none"> ■ Delete unused files from the USB flash drive, and then try again. ■ Change the file name by doing one of the following: <ul style="list-style-type: none"> • See <i>Change Scan Settings (ControlCenter4) (Windows®)</i> on page 100. • See <i>Change Scan Settings (ControlCenter2) (Macintosh)</i> on page 120. • See <i>Change Scan to PC Settings (Windows®)</i> on page 212. • See <i>Change Scan to PC Settings (Macintosh)</i> on page 220. • See <i>Save Scanned Documents on a USB Flash Drive</i> on page 158.

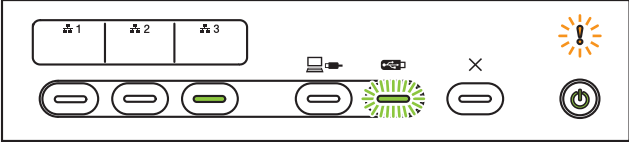
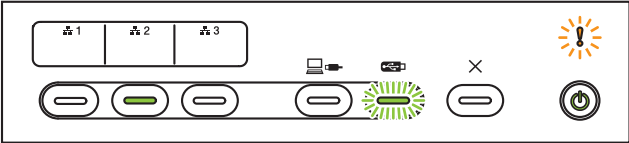
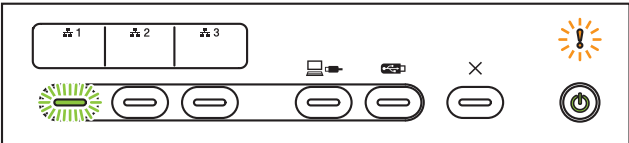
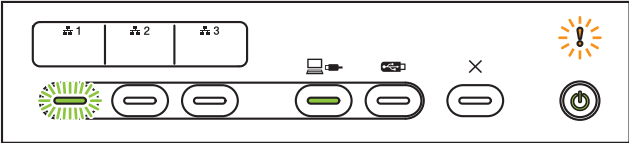
LEDs	Machine Status
	<p>Write Protect</p> <p>The media is write protected. To clear the error, press the Stop key.</p>
	<p>Access Error</p> <p>The media has been removed. To clear the error, press the Stop key.</p>
	<p>Authenticate Error (Scan to FTP)</p> <p>The FTP user name and password you entered are incorrect or not configured correctly.</p> <p>Confirm that the user name and password are configured or entered correctly, and then try again.</p>
	<p>Server Time Out (Scan to FTP)</p> <p>Check the following, and then try again:</p> <ul style="list-style-type: none"> • The network settings are correct. • Your wireless access point/router is turned on. • The remote FTP server is turned on. • The name (or IP address) of the FTP remote server is correct.

B

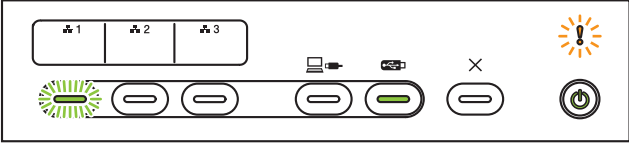
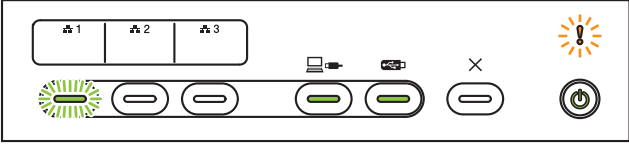
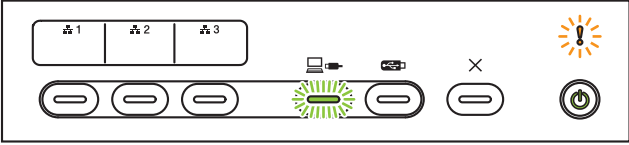
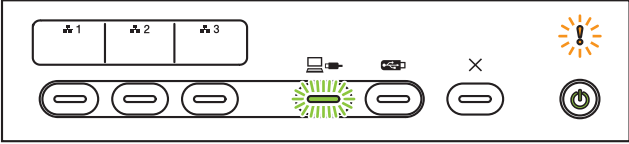
LEDs	Machine Status
	<p>Sending Error (Scan to FTP)</p> <p>Check the following, and then try again:</p> <ul style="list-style-type: none"> • You have writing permission for the destination folder. • The hard disk containing the destination folder is not full. (For example, if the hard disk is full, free some disk space, and then try again.)
	<p>Out of Memory (Scan to FTP)</p> <p>The machine's memory is full and the machine cannot scan the entire document. To clear the error, do one of the following:</p> <ul style="list-style-type: none"> ■ Press any button. ■ Unplug the machine from the AC power outlet, and then plug the machine in again. <p>To prevent the error, do one of the following:</p> <ul style="list-style-type: none"> ■ Place fewer pages in the ADF. ■ Set a smaller resolution or file size.
	<p>Out of Memory (Scan to PC)</p> <p>Check the following, and then try again:</p> <ul style="list-style-type: none"> • You have writing permission for the destination folder. • The hard disk containing the destination folder is not full. (For example, if the hard disk is full, free some disk space and then try again.)
	<p>Out of Memory (WS Scan)</p> <p>Check the following, and then try again:</p> <ul style="list-style-type: none"> • You have writing permission for the destination folder. • The hard disk containing the destination folder is not full. (For example, if the hard disk is full, free some disk space and then try again.)

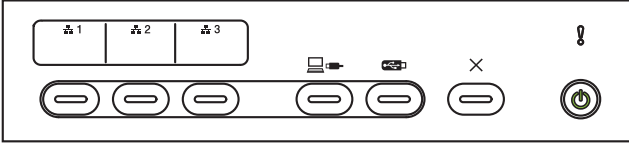
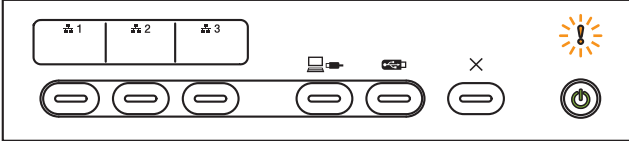
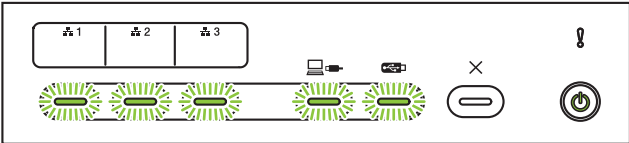
LEDs	Machine Status
	<p>Sleep Time</p> <p>The machine is in Sleep Time. The machine acts as though it is turned off.</p> <p>Do one of the following to wake up the machine:</p> <ul style="list-style-type: none"> ■ Press the Power key. ■ Open the ADF. ■ Load your document. ■ Touch the screen. ■ Touch IC Card to the NFC reader. <p>The machine will enter Ready Mode.</p>
	<p>Document Jam</p> <p>Clear the document jam (see <i>Document Jam</i> on page 266), and then do the following:</p> <ul style="list-style-type: none"> ■ If scanning a long document, select Long Paper (Auto) from the Scan Size or Document Size drop-down list. <p>To change the settings, do one of the following:</p> <ul style="list-style-type: none"> ■ See <i>Change Scan Settings (ControlCenter4) (Windows®)</i> on page 100. ■ See <i>Change Scan Settings (ControlCenter2) (Macintosh)</i> on page 120. ■ See <i>Change Scan to PC Settings (Windows®)</i> on page 212. ■ See <i>Change Scan to PC Settings (Macintosh)</i> on page 220.
	<p>Ejecting Paper</p> <p>If the machine stopped while ejecting the document, press the Stop button to continue ejecting the pages.</p>

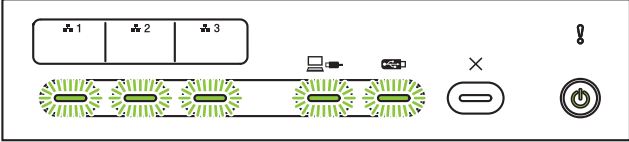
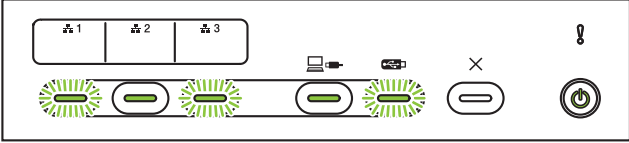
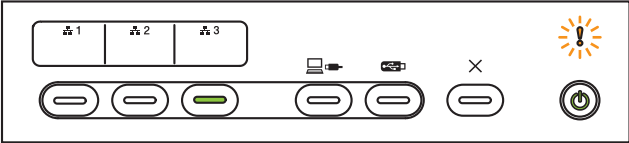
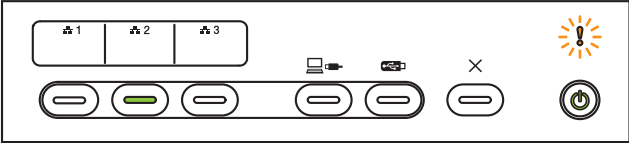
LEDs	Machine Status
 <p>The diagram shows a control panel with three status LEDs labeled 1, 2, and 3. LED 1 is lit green, LED 2 is lit green, and LED 3 is lit green. To the right of the LEDs are icons for a printer, a USB drive, a power button, a stop button (X), and a power button.</p>	<p>Stopped Ejecting</p> <p>The machine has stopped ejecting the document or plastic cards. To continue ejecting, press the Stop button.</p>
 <p>The diagram shows a control panel with three status LEDs labeled 1, 2, and 3. LED 1 is lit green, LED 2 is lit green, and LED 3 is lit green. To the right of the LEDs are icons for a printer, a USB drive, a power button, a stop button (X), and a power button.</p>	<p>Remote Setup</p> <p>Remote Setup is in process. To cancel Remote Setup, click the Stop button in the Remote Setup window on your computer.</p>
 <p>The diagram shows a control panel with three status LEDs labeled 1, 2, and 3. LED 1 is lit green, LED 2 is lit green, and LED 3 is lit green. To the right of the LEDs are icons for a printer, a USB drive, a power button, a stop button (X), and a power button.</p>	<p>Scan Exceeded a Specific Area</p> <p>The machine has scanned a document that is more than 5 m using the Long Paper setting. To clear the error, press the Stop key.</p>
 <p>The diagram shows a control panel with three status LEDs labeled 1, 2, and 3. LED 1 is lit green, LED 2 is lit green, and LED 3 is lit green. To the right of the LEDs are icons for a printer, a USB drive, a power button, a stop button (X), and a power button.</p>	<p>Multifeed Detection Error</p> <p>A multifeed has occurred. To clear the error, press the Stop key.</p>

B

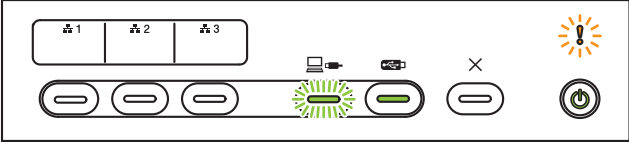
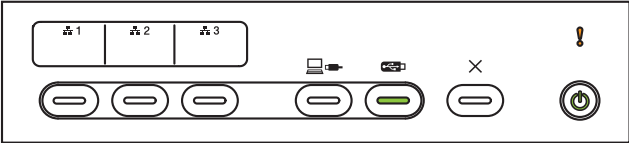
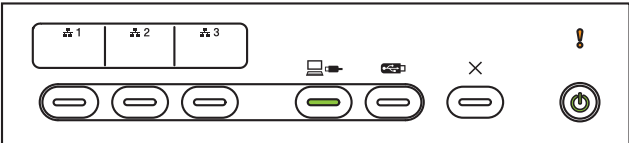
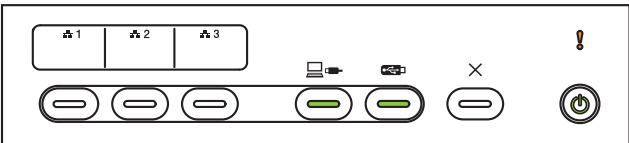
LEDs	Machine Status
 <p>The diagram shows a control panel with three indicator lights labeled 1, 2, and 3. Below them are several buttons and a power button. The second indicator light from the left is illuminated with a green glow, and a power button on the right is also illuminated with a green glow. An orange warning icon (exclamation mark inside a triangle) is shown in the top right corner of the panel area.</p>	<p>Front Cover open The Front Cover is open.</p>
 <p>The diagram shows the same control panel as above. The second indicator light from the left is illuminated with a green glow. A power button on the right is also illuminated with a green glow. An orange warning icon (exclamation mark inside a triangle) is shown in the top right corner of the panel area.</p>	<p>Pick Up Roller Alert The maximum Pick Up Roller Counter has been exceeded. To clear the error, do one of the following:</p> <ul style="list-style-type: none"> ■ Reset the Pick Up Roller Counter. ■ Insert documents.
 <p>The diagram shows the same control panel as above. The fourth indicator light from the left is illuminated with a green glow. A power button on the right is also illuminated with a green glow. An orange warning icon (exclamation mark inside a triangle) is shown in the top right corner of the panel area.</p>	<p>Reverse Roller Alert The Reverse Roller has been used over 200,000 times. To clear the error, do one of the following:</p> <ul style="list-style-type: none"> ■ Reset the Reverse Roller Counter. ■ Insert documents.
 <p>The diagram shows the same control panel as above. The second and fourth indicator lights from the left are both illuminated with a green glow. A power button on the right is also illuminated with a green glow. An orange warning icon (exclamation mark inside a triangle) is shown in the top right corner of the panel area.</p>	<p>Pick Up Roller & Reverse Roller Alert The Pick Up Roller and Pick Up Roller Counter have been used over the limit. To clear the error, do one of the following:</p> <ul style="list-style-type: none"> ■ Reset the Pick Up Roller Counter. ■ Reset the Reverse Roller Counter. ■ Insert documents.

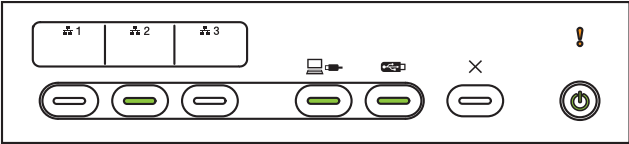
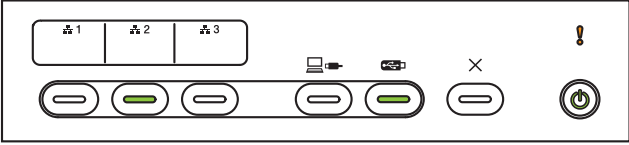
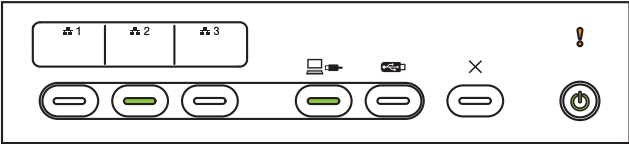
LEDs	Machine Status
	<p>Pick Up Roller & Reverse Roller alert & Periodic Cleaning Alert</p> <p>The Pick Up Roller and Periodic Cleaning Counter have been used over the limit. To prevent the error, do one of the following:</p> <ul style="list-style-type: none"> ■ Reset the Pick Up Roller Counter. ■ Reset the Reverse Roller Counter. ■ Reset the Periodic Cleaning Counter. ■ Insert documents.
	<p>Pick Up Roller & Periodic Cleaning Alert</p> <p>The Pick Up Roller and Periodic Cleaning Counter have been used over the limit. To prevent the error, do one of the following:</p> <ul style="list-style-type: none"> ■ Reset the Pick Up Roller Counter. ■ Reset the Periodic Cleaning Counter. ■ Insert documents.
	<p>Reverse Roller alert & Periodic Cleaning Alert</p> <p>The Reverse Roller has been used over 200,000 times and Periodic Cleaning Counter has exceeded the limit.</p> <ul style="list-style-type: none"> ■ Reset the Reverse Roller Counter. ■ Reset the Periodic Cleaning Counter. ■ Insert documents.

Service Call Indications

If there is an error that you cannot clear yourself, the machine will indicate the need for a service call by lighting up all the LEDs as shown below.

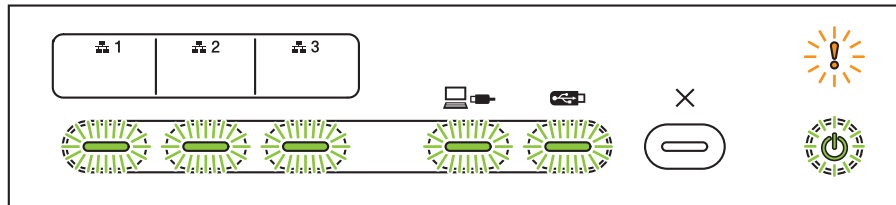

If you see the service call indication shown above, turn the machine off and then on, and then try to scan again.

If the error is not cleared after turning the machine off and on, press Stop. The LEDs will light up as shown in the table below to identify the error.

Error Code	Network Device 1	Network Device 2	Network Device 3	Scan to PC	Scan to USB	Error Indicator	Power Indicator
A7: Not a ROM of matching color Parameter to CIS Maker							
A8: Matching failure of color parameter							
Ex: Unregistered wireless MAC address							
Ex: Unregistered wired MAC address							
A9: Detected a special scanning error							
E9: NFC module initialization failure							
FE: ROM1 data acquisition error							

B

Scan Settings

If the machine is connected to a computer, see the table below for available settings when scanning from the computer.

Category	Setting	Option	Configurable settings in TWAIN	Configurable settings in CC4
Basic Settings	2-sided Scan	Off / Long Edge / Short Edge	✓	✓
	Scan Type	Auto / Black and White / True Gray / 24bit Color	✓	✓
		Gray (Error Diffusion)	✓	✓
	Resolution	100 dpi / 150 dpi	✓	✓
		200 dpi / 300 dpi / 600 dpi	✓	✓
		400 dpi	✓	✓
		1200 dpi	✓	✓
	File Type	PDF Single-Page/PDF Multi-Page/JPEG/TIFF Single-Page/TIFF Multi-Page	-	✓
		PDF/A Single-Page / PDF/A Multi-Page / Secure PDF Single-Page / Secure PDF Multi-Page / High Compression PDF Single-Page / High Compression PDF Multi-Page / Searchable PDF Single-Page / Searchable PDF Multi-Page	-	✓
		Signed PDF Single-Page / Signed PDF Multi-Page	-	-
		Windows Bitmap (.bmp) / Portable Network Graphics (.png) / XPS	-	✓
	Document Size	Auto / A4 / Letter / Legal / JIS B5 / A5 / JIS B6 / A6 / Business Card / Long Paper (Auto)	✓	✓
		Executive / Index Card / Photo / Photo L / Photo 2L / Post Card 1 / Post Card 2 (Double) / Folio	✓	✓
		1 to 2(A3) / 1 to 2(Ledger) / 1 to 2(B4) / 1 to 2(A4) / 2 in 1(A4) / 2 in 1(Letter) / 2 in 1(A5) / 2 in 1(B5)	-	✓
		Custom	✓	-
	File Size (Compression rate adjustment)	-	-	✓

Category	Setting	Option	Configurable settings in TWAIN	Configurable settings in CC4	
Image Processing	Auto Deskew	On / Off	✓	✓	
	Remove Background Color	Bleed Through / Remove Background Color	✓	✓	
	Color Tone Adjustment	Auto		✓	-
		Custom	Brightness	✓	✓
			Contrast	✓	✓
			Shadow	✓	-
			Highlight	✓	-
			Gamma	✓	-
	Grayscale Adjustment	Brightness / Contrast	✓	-	
	Auto Color Detect Adjust	Auto Color Detect Adjust	✓	-	
	Skip Blank Page	Skip Blank Page	✓	✓	
	Margin Setting for Cropping	Top: -0.12~0.12 in. (-3.0~3.0 mm) Left: -0.12~0.12 in. (-3.0~3.0 mm) Right: -0.12~0.12 in. (-3.0~3.0 mm) Bottom: -0.12~0.12 in. (-3.0~3.0 mm)	✓	-	
	Punch Hole Removal	Paint color White / Background color	✓	-	
	Edge Emphasis	On (Low, Middle, High) / Off	✓	-	
	Boldface Formatting	On (Low, Middle, High) / Off	✓	-	
	Blurred Character Correction	On / Off	✓	-	
	Noise Reduction	On (Low, Middle, High) / Off	✓	-	
	Remove Ruled Line	Vertical / Horizontal / Vertical and Horizontal	✓	-	
Edge Fill	White / Black	✓	-		
Color Drop	Chromatic Color / Red / Green / Blue / Custom	✓	-		
Special Mode	Multifeed Detection	On / Off	✓	✓	
	Carrier Sheet Mode	On / Off	✓	✓	
	Plastic Card Mode	On / Off	✓	✓	
Detail Settings	Continuous Scan	On / Off	✓	✓	
	Single Page Scan	On / Off	✓	-	

If the machine is connected to a computer, see the table below for available settings when scanning from the control panel.

Category	Setting	Option	Configurable settings from CC4 (ADS-2400N / ADS-3000N / ADS-2800W / ADS-3600W)	Configurable settings in Control Panel (ADS-2800W / ADS-3600W)	Saving settings to a shortcut (ADS-2800W / ADS-3600W)
Basic Settings	2-sided Scan	Off / Long Edge / Short Edge	✓	✓	✓
	Scan Type	Auto / Black and White / True Gray / 24bit Color	✓	✓	✓
		Gray (Error Diffusion)	✓	-	-
	Resolution	100 dpi	✓	-	-
		150 dpi / 200 dpi / 300 dpi / 600 dpi	✓	✓	✓
		400 dpi	✓	-	-
		1200 dpi	✓	-	-
	File Type	PDF Single-Page / PDF Multi-Page / JPEG / TIFF Single-Page / TIFF Multi-Page	✓	✓	✓
		PDF/A Single-Page / PDF/A Multi-Page / Secure PDF Single-Page / High Compression PDF Single-Page / High Compression PDF Multi-Page / Searchable PDF Single-Page / Searchable PDF Multi-Page	✓	-	-
		Signed PDF Single-Page / Signed PDF Multi-Page	-	-	-
		Windows Bitmap (.bmp) / Portable Network Graphics (.png) / Microsoft Office Word (*.docx) / Microsoft Office PowerPoint (*.pptx) / XPS	✓	-	-
		Secure PDF Multi-Page / Signed PDF Single-Page	-	-	-
	Document Size	Auto / A4 / Letter / Legal / JIS B5 / A5 / JIS B6 / A6 / Business Card / Long Paper (Auto)	✓	✓	✓
		A3 / Ledger / JIS B4 / Executive / Index Card / Photo / Photo L / Photo 2L / Post Card 1 / Post Card 2 (Double) / Folio	✓	-	-
		1 to 2(A3) / 1 to 2(Ledger) / 1 to 2(B4) / 1 to 2(A4) / 2 in 1(A4) / 2 in 1(Letter) / 2 in 1(A5) / 2 in 1(B5)	✓	-	-
		Custom	-	-	-
	File Size (Compression rate adjustment)	-	✓	-	-

Category	Setting	Option	Configurable settings from CC4 (ADS-2400N / ADS-3000N / ADS-2800W / ADS-3600W)	Configurable settings in Control Panel (ADS-2800W / ADS-3600W)	Saving settings to a shortcut (ADS-2800W / ADS-3600W)	
Image Processing	Auto Deskew	On / Off	✓	✓	✓	
	Remove Background Color	Bleed Through / Remove Background Color	✓	-	-	
	Color Tone Adjustment	Custom	Auto	-	-	-
			Brightness	✓	✓	✓
			Contrast	✓	✓	✓
			Shadow	✓	-	-
			Highlight	✓	-	-
	Gamma	✓	-	-		
	Grayscale Adjustment	Brightness / Contrast	-	-	-	
	Auto Color Detect Adjust	Auto Color Detect Adjust	-	-	-	
	Skip Blank Page	Skip Blank Page	✓	✓	✓	
	Margin Setting for Cropping	Top: -0.12~0.12 in. (-3.0~3.0 mm) Left: -0.12~0.12 in. (-3.0~3.0 mm) Right: -0.12~0.12 in. (-3.0~3.0 mm) Bottom: -0.12~0.12 in. (-3.0~3.0 mm)	-	-	-	
	Punch Hole Remobval	Paint color White / Background color	-	-	-	
	Edge Enhancement	-	-	-	-	
	Boldface Formatting	-	-	-	-	
	Blurred Character Correction	On / Off	-	-	-	
Noise Reduction	-	-	-	-		
Remove Ruled Line	Vertical / Horizontal / Vertical and Horizontal	-	-	-		
Edge Fill	White / Black	-	-	-		
Color Drop	Chromatic Color / Red / Green / Blue / Custom	-	-	-		
Special Mode	Multifeed Detection	On / Off	✓	-	-	
	Carrier Sheet Mode	On / Off	✓	-	-	
	Plastic Card Mode	On / Off	✓	-	-	
Detail Settings	Continuous Scan	On / Off	✓	✓	✓	
	Detect End of Page	On / Off	-	-	-	

If the machine is not connected to a computer, see the table below for available settings when scanning from the control panel.

Category	Setting	Option	Configurable settings in Control Panel (ADS-2800W / ADS-3600W)	Saving settings to a shortcut (ADS-2800W / ADS-3600W)
Basic Settings	2-sided Scan	Off / Long Edge / Short Edge	✓	✓
	Scan Type	Auto / Black and White / True Gray / 24bit Color	✓	✓
		Gray (Error Diffusion)	-	-
	Resolution	100 dpi	-	-
		150 dpi / 200 dpi / 300 dpi / 600 dpi	✓	✓
		400 dpi	-	-
		1200 dpi	-	-
		Auto	✓	✓
	File Type	PDF Single-Page / PDF Multi-Page / JPEG / TIFF Single-Page / TIFF Multi-Page	✓	✓
		PDF/A Single-Page / PDF/A Multi-Page / Secure PDF Single-Page / Secure PDF Multi-Page / High Compression PDF Single-Page / High Compression PDF Multi-Page / Searchable PDF Single-Page / Searchable PDF Multi-Page	✓	✓
		Signed PDF Single-Page / Signed PDF Multi-Page	✓	✓
		Windows Bitmap (.bmp) / Portable Network Graphics (.png) / XPS	-	-
		Auto / A4 / Letter / Legal / JIS B5 / A5 / JIS B6 / A6 / Business Card / Long Paper (Auto)	✓	✓
	Document Size	A3 / Ledger / JIS B4 / Executive / Index Card / Photo / Photo L / Photo 2L / Post Card 1 / Post Card 2 (Double) / Folio	-	-
		1 to 2(A3) / 1 to 2(Ledger) / 1 to 2(B4) / 1 to 2(A4) / 2 in 1(A4) / 2 in 1(Letter) / 2 in 1(A5) / 2 in 1(B5)	-	-
		Custom	-	-
		File Size (Compression Rate Adjustment)	-	✓

Category	Setting	Option	Configurable settings in Control Panel (ADS-2800W / ADS-3600W)	Saving settings to a shortcut (ADS-2800W / ADS-3600W)	
Image Processing	Auto Deskew	On / Off	✓	✓	
	Remove Background Color	Bleed Through / Remove Background Color	-	-	
	Color Tone Adjustment	Auto		-	-
		Custom	Brightness	✓	✓
			Contrast	✓	✓
	Grayscale Adjustment	Brightness / Contrast	-	-	
	Auto Color Detect Adjust	Auto Color Detect Adjust	✓	✓	
	Skip Blank Page	Skip Blank Page	✓	✓	
	Margin Setting for Cropping	Top: -0.12~0.12 in. (-3.0~3.0 mm) Left: -0.12~0.12 in. (-3.0~3.0 mm) Right: -0.12~0.12 in. (-3.0~3.0 mm) Bottom: -0.12~0.12 in. (-3.0~3.0 mm)		✓	✓
	Punch Hole Removal	Paint color White / Background color	-	-	
	Edge Enhancement	-	-	-	
	Boldface Formatting	-	-	-	
	Blurred Character Correction	On / Off	-	-	
	Noise Reduction	-	-	-	
	Remove Ruled Line	Vertical / Horizontal / Vertical and Horizontal	-	-	
Edge Fill	White / Black	-	-		
Color Drop	Chromatic Color / Red / Green / Blue / Custom	-	-		
Special Mode	Multifeed Detection	On / Off	-	-	
	Carrier Sheet Mode	On / Off	-	-	
	Plastic Card Mode	On / Off	-	-	
Detail Settings	Continuous Scan	On / Off	✓	✓	
	Detect End of Page	On / Off	-	-	

C

Index

A

ABBYY FineReader Pro (Macintosh) 144

B

Brother
 Apps 15
 Brother Numbers i
 Customer Serviceii
 FAQs (Frequently Asked Questions) i
 Product Supportii
 Solutions Center i

C

ControlCenter2
 Macintosh220, 233
ControlCenter4
 Windows®78, 212

D

Device Selector74, 238
Drivers
 Macintosh
 ICA 148
 TWAIN 144
 Windows®
 TWAIN 126
 WIA 126

L

LCD (Liquid Crystal Display)
 Brightness 34
 Dim Timer 34

M

Memory Storage 35

N

Nuance PaperPort 14SE (Windows) 126

P

Power Failure 35

R

Remote Setup 235

S

Scan
 Macintosh
 ABBYY FineReader 144
 ICA Compliant 148
 TWAIN Compliant 144
 Windows®
 Nuance PaperPort 14SE 126
 TWAIN Compliant 126
 WIA Compliant 126
Sleep Time 36
Status Monitor
 Macintosh 233
 Windows® 230

T

Text, entering 285
Troubleshooting 262

V

Volume, Setting
 Beeper 35

W

Web Connect iii
WiFi Direct™ 10

Brother International Corporation
200 Crossing Boulevard
P.O. Box 6911
Bridgewater, NJ 08807-0911 USA

Brother International Corporation (Canada) Ltd.
1 rue Hôtel de Ville,
Dollard-des-Ormeaux, QC, Canada H9B 3H6

brother

Visit us on the World Wide Web
www.brother.com

These machines are approved for use in the country of purchase only. Local Brother companies or their dealers will support only machines purchased in their own countries.



www.brotherearth.com