



HP Scanjet Enterprise 7500/Flow 7500

User Guide

Copyright and license

© 2013 Copyright Hewlett-Packard Development Company, L.P.

Reproduction, adaptation or translation without prior written permission is prohibited, except as allowed under the copyright laws.

The information contained herein is subject to change without notice.

The only warranties for HP products and services are set forth in the express warranty statements accompanying such products and services. Nothing herein should be construed as constituting an additional warranty. HP shall not be liable for technical or editorial errors or omissions contained herein.

Trademark credits

ENERGY STAR is a U.S. registered service mark of the United States Environmental Protection Agency.

Microsoft and Windows are registered trademarks of Microsoft Corporation.

Edition 2, 10/2013

Table of contents

1 Scanner overview	1
Scanner components	1
Scanner front panel	1
USB and power connections	3
Scanner software	3
HP Smart Document Scan Software	3
HP Scanner Tools Utility	5
Power use	5
2 Use the scanner	7
Load originals	7
Use the automatic document feeder (ADF)	7
Document loading tips	7
How to load documents	9
Use the scanner glass	10
Scan documents	11
Tips on scanning	11
Scan from the scanner buttons	12
Scan from HP Smart Document Scan Software	12
Scan from ISIS- or TWAIN-compliant scanning software	12
3 Useful scanner features	13
Work with scan profiles	13
View profiles	13
Create HP Smart Document Scan Software profiles	14
Create scan profiles that use third-party scanning software	15
Import and export HP Smart Document Scan Profiles	15
Scan extra long documents	15
Reduce file size with hardware compression	16
Filter out color from a document (color dropout)	16
Automatically crop scanned image	17
Automatically detect color	17
Misfeed (multipick) detection	18
4 Care and maintenance	19
HP Scanner Tools Utility Maintenance tab	19

Order maintenance and scanning supplies	19
Clean the scanner glass, scanning strip, and automatic document feeder (ADF) duplex background	20
Clean the rollers	21
Replace the rollers	23
Replace the separation pad	26
Replace the front panel	29
5 Troubleshooting	33
Scanner errors	33
Basic troubleshooting tips	34
Scanner installation troubleshooting	35
Check the cables	35
Uninstall and then reinstall the HP Scanjet utilities	35
Scanner initialization or hardware problems	36
Check the USB connection	36
Check that the scanner has power	37
Reset the scanner	37
The scanner has stopped working correctly	38
Scanner operation problems	38
Scanner will not turn on	39
Scanner keeps turning off	39
The LCD is having display issues or scanner buttons are not working as expected	39
Scanner does not scan right away	40
Scanner scans only one side of a two-sided page	40
Scanned pages are missing at the scan destination	40
Scanned image is fuzzy	40
Scanned pages are out of order at the scan destination	40
Optimize scanning and task speeds	41
The scan is completely black or completely white	41
Scanned images are not straight	41
Vertical white stripes appear on the printed page	41
Vertical colored stripes appear on the printed page	41
Scan files are too large	42
Scanner buttons are not working correctly	42
Scanner paper path problems	43
Paper jamming, skewing, misfeeds, or multiple-page feeds	43
Scanning fragile originals	43
Paper does not feed from the scanner	43
Originals are curling up in the scanner output tray.	44
The bottom of the scanned image is cut off	44

The scanned images have streaks or scratches	44
An item loaded in the scanner jams repeatedly	44
Clear jams from the scanner paper path	45
6 Product accessibility and support	47
LCD Reader	47
Control of the scanner buttons	47
7 Specifications and warranty	49
Scanner specifications	49
Document feeder specifications	49
Environmental specifications	50
Regulatory information	50
Energy information	50
Disposal of Waste Equipment by Users in Private Households in the European Union	51
Hewlett-Packard limited warranty statement	51
Index	53

1 Scanner overview

This User Guide covers what you need to know about using your scanner.

- [Scanner components](#)
- [Scanner software](#)
- [Power use](#)

Scanner components

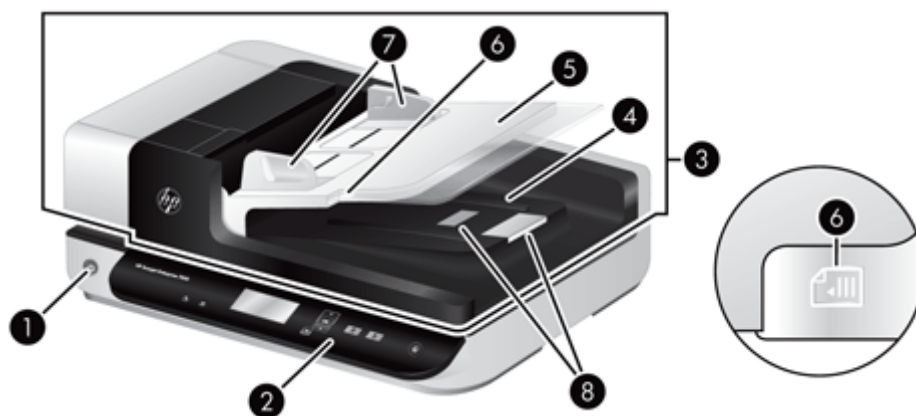







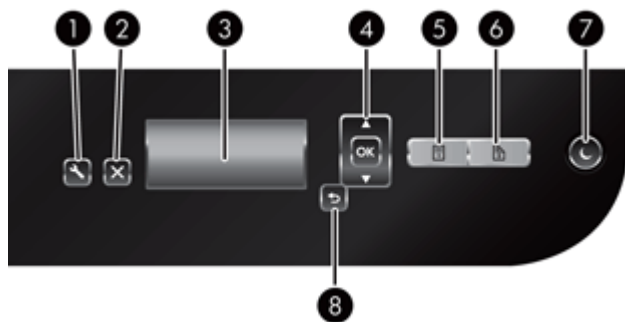

1	Power button
2	Front panel
3	Automatic document feeder (ADF)
4	ADF output tray
5	ADF input tray
6	Document load/detect LED
7	Paper guides
8	Paper stops

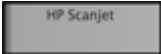
Scanner front panel

Use the buttons on the scanner front panel to start a scan and to configure some scanner settings.



Icon	Button name	Description
1 	Tools	Opens the HP Scanner Tools Utility where you can perform the following tasks: <ul style="list-style-type: none"> • Configure the list of profiles on the scanner front panel • Create scan profiles that use third-party scanning software • Change the scanner power management settings • View information about scanner settings, status, and maintenance
2 	Cancel	Cancels a scan in progress.
3 	LCD	Displays available scan profiles and status and error messages.
4 	OK/Select	Allows you to scroll the list of scan profiles and view their details. <ul style="list-style-type: none"> • Press ▲ and ▼ to scroll through profiles. • Press OK to view scan profile details or return to the list of profiles when viewing scan profile details.
5 	Scan Simplex	Starts a one-sided scan.
6 	Scan Duplex	Starts a two-sided scan.
7 	Sleep	Initiates Sleep Mode. When in Sleep Mode, pressing this button wakes up the scanner.
8 	Back	Returns you to the list of profiles when you are viewing profile details.

USB and power connections

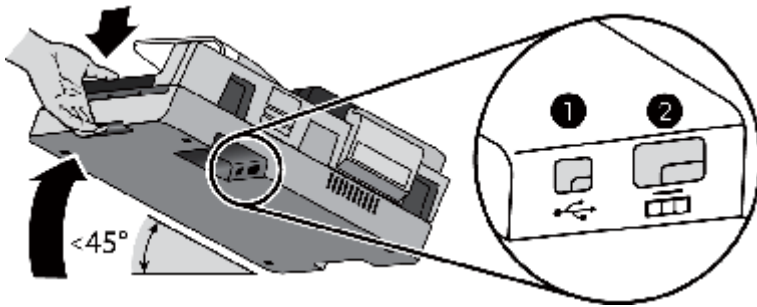

Callout	Description
1	USB input
2	Power supply input

CAUTION: Use care when tilting the unit and do not allow the automatic document feeder (ADF) cover to open accidentally.

Scanner software

The scanner comes with an assortment of scanning and document-management programs, including:

- [HP Smart Document Scan Software](#)
- [HP Scanner Tools Utility](#)

HP Smart Document Scan Software



HP Smart Document Scan Software guides you through the scanning process. To open the software, double-click the **HP Smart Document Scan Software** icon on the desktop. For more information, see the HP Smart Document Scan Software Help.

Main Window

The Main Window is displayed when you open the HP Smart Document Scan software. Use this window to complete the following tasks:

- **Start a scan:** Load the original in the document feeder, select a profile, and then click **Scan**. The scan will be completed using the settings associated with the selected profile.
- **Work with profiles:** Create and modify profiles to specify the scanner settings and the actions to take on your scanned documents.

Scan Progress Window

The Scan Progress Window opens when you start a scan. Use this window to complete the following tasks:

- View thumbnails of the pages as they are scanned
- Scan more pages
- Rescan pages individually
- Edit pages individually to crop, rotate, and deskew the images.
- Reorganize or delete pages
- Complete the scan and process the document

For more information, click **Help** on the HP Smart Document Scan Software menu bar.

HP Scanner Tools Utility

Use the HP Scanner Tools Utility to configure the list of scan profiles on the scanner front panel, to create scan profiles that use third-party scanning software, to change the scanner's power management settings, and to find information about scanner settings, status, and maintenance.



To open the utility, do one of the following:

- Double-click the **HP Scanner Tools Utility** icon on the desktop.
- Press the **Tools** (🔧) button on the scanner front panel.
- Click **Start**, point to **Programs** or **All Programs**, point to **HP**, point to **Scanjet**, point to **7500**, and then click **Scanner Tools Utility**.

For more information, see the HP Scanner Tools Utility Help.

Power use

By default, the scanner will enter Sleep Mode after 15 minutes of inactivity, and will turn off automatically after two hours of inactivity to conserve power. To change the default settings or disable these modes, complete these steps.

1. Press the **Tools** (🔧) button to start the HP Scanner Tools Utility.
2. Click the **Settings** tab, and then select the appropriate Sleep Mode and Auto-Off settings.
 - To specify the period of inactivity after which the scanner goes into Sleep Mode, select **15 minutes** or **Never** from the **Sleep: Put the scanner to sleep after:** drop-down list.
 - To specify the period of inactivity after which the scanner automatically turns off, select the appropriate value from the **Auto-Off: Turn off the scanner after:** drop-down list.

2 Use the scanner

The following topics describe the HP Scanjet 7500/Flow 7500 scanner as well as how to scan originals.

- [Load originals](#)
- [Scan documents](#)

Load originals

You can load originals into your scanner using one of the following methods:

- [Use the automatic document feeder \(ADF\)](#)
- [Use the scanner glass](#)

Use the automatic document feeder (ADF)

For helpful information on loading your documents properly, refer to the following topics.













- [Document loading tips](#)
- [How to load documents](#)

Document loading tips

- The maximum capacity of the document feeder and output tray varies by paper size and weight. For 75 g/m² (20 lb) paper (the standard weight for most printer and photocopier paper), the maximum capacity is 100 sheets. For heavier paper, the maximum capacity is less.
- The automatic document feeder (ADF) supports the following paper types.

	Width	Length	Weight (or thickness)
Standard stock (single page)	68-216 mm (2.7-8.5 in)	148-864 mm (5.8-34 in)	49-120 g/m ² (13-32 lbs)
Standard stock (multiple pages)	68-216 mm (2.7-8.5 in)	148-356 mm (5.8-14 in)	49-120 g/m ² (13-32 lbs)

- In the scanning software, always specify the following items:
 - Set the page size to match the width and length of the paper that you are scanning.
 - Select a profile whose page loading selection matches the edge you are feeding first.
- Scanning the following types of documents with the ADF might result in paper jams or damage to the documents. To scan these documents, use the scanner glass instead of the ADF.

	Wrinkled or creased documents		Curled documents
	Torn documents		Documents with paper clips or staples
	Carbon paper		Coated paper
	Extremely thin, translucent paper		Paper with adhesive notes or flags attached
	Photos		Overhead transparencies
	Papers that are stuck together		Paper with wet substances such as glue or correction fluid

- Smooth out any folds or curls in your documents before placing them into the feeder. If the leading edge of a document is curled or folded, it may cause a paper jam.
- When loading paper that is smaller than 148 mm (5.8 in) in width, place the long edge of the page parallel to the paper guides.
- To scan fragile documents (such as photos or documents on wrinkled or very lightweight paper), place the document face down on the scanner glass.
- Make sure that the hatch on the document feeder is securely latched. To properly close the hatch, press until you hear a click.
- Adjust the paper guides to the width of the documents. Make sure that the paper guides touch the edges of the original. If there is any clearance between the paper guides and the edges of the documents, the scanned image might be skewed.
- When placing a stack of documents into the feeder, gently set the stack in the document feeder. Do not drop the stack into the feeder.

 **TIP:** The document load/detect LED on the clear portion of the document feeder input tray is on when documents are positioned correctly.

- To prevent skewing, always load stacks of documents of the same dimensions. However, if you must load stacks of mixed document sizes, center all documents in the stack by width before inserting them in the document feeder.
- Clean the scanning rollers if the rollers are visibly dirty or after scanning a document that has pencil writing on it.

How to load documents

1. Adjust the paper guides to the width of the documents. Take care not to overtighten the guides, which can restrict paper feeding.



When scanning small originals such as checks, it is especially important that the paper guides fit snugly against the edges of the original.

2. Fan the stack of document pages to ensure that the pages do not stick together. Fan the edge that will be pointing into the feeder in one direction, and then fan that same edge in the opposite direction.



3. Align the edges of the documents by tapping the bottom of the stack against the table top. Rotate the stack 90 degrees and repeat.

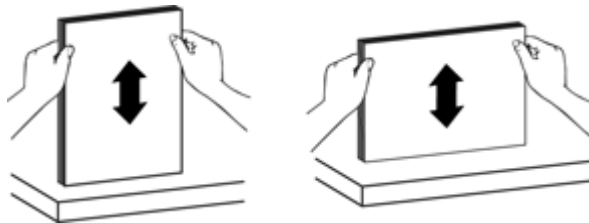

4. Gently set the stack in the document feeder. Load the pages face up with the top of the pages pointing into the feeder.

For best results, do not drop the stack into the feeder and do not tap the top edge of the stack after you have placed it in the document feeder.



 **TIP:** Avoid feeding a document with a leading edge that has been folded or frayed. When you begin scanning, select a profile whose page loading selection matches the edge you are feeding first to ensure that the scan reflects the orientation of the original document.

5. Verify that the paper guides are aligned with the edges of the stack.

Use the scanner glass

Place items that do not meet the specifications for the automatic document feeder (ADF) directly onto the scanner glass.

Minimum size:	No minimum size
Maximum size:	216 x 356 mm (8.5 x 14 in)

 **NOTE:** Not all the length of the scanner glass is in the active imaging area, so make sure to position your originals as indicated by the reference mark on the edge of the scanner glass.

Place the original face down on the scanner glass, as indicated by the reference mark. For landscape pages, place the page face down with the top of the page pointing toward the back of the scanner.



 **TIP:** To scan multiple pictures at the same time, arrange the pictures that you want to scan on the scanner glass with at least 6 mm (0.25 in) of space between items.



Scan documents

The following topics describe how to scan originals using the scanner and the scanner software.

- [Tips on scanning](#)
- [Scan from the scanner buttons](#)
- [Scan from HP Smart Document Scan Software](#)
- [Scan from ISIS- or TWAIN-compliant scanning software](#)

Tips on scanning



- If the scanner LCD does not display any scan profiles, open the HP Scanner Tools Utility to load the profiles onto the scanner.
- To reduce paper jams, use scan settings that specify the actual dimensions of the pages that you are scanning.
- To cancel a scan, press the **Cancel (X)** button.
- If you press **Scan Duplex (H)** and the selected profile is configured to use the automatic document feeder (ADF), the scanner processes both sides of the original regardless of the scan profile setting. If you press **Scan Simplex (I)**, the scanner processes the face up side of the original when scanning from the ADF or the face down side when scanning from the scanner glass.



 **NOTE:** If the selected scan profile is configured to use the scanner glass (rather than the ADF), the scanner processes only one side of the original regardless of the scan button ( or ) you press.



- You can create scan profiles that use third-party scanning software. For more information, see the HP Scanner Tools Utility Help.

Scan from the scanner buttons

To scan using the scanner buttons, follow these steps:

1. Load the originals.
2. Use  and  to select the scan profile you want.

 **TIP:** Pressing **OK** displays the scan profile's file type, color mode, and resolution. To return to the profiles list, press the **Back** () button.

3. Press either **Scan Simplex** () for one-sided scans or **Scan Duplex** () for two-sided scans.

Scan from HP Smart Document Scan Software

You can start a scan from the HP Smart Document Scan Software.

1. Do one of the following:
 - Double-click the **HP Smart Document Scan Software** icon on the computer desktop.



- Click **Start**, point to **Programs** or **All Programs**, point to **HP**, and then click **HP Smart Document Scan Software**.
2. Select a profile, and then click **Scan**.

 **TIP:** A description of the selected profile is displayed below the list.

3. Click **Done** to process the scan and send it to the destination defined in the scan profile.

For more information, see the HP Smart Document Scan Software Help.

Scan from ISIS- or TWAIN-compliant scanning software

You can scan an image or document directly into a software program if the program is ISIS- or TWAIN-compliant. Generally, the program is compliant if it has a menu option such as **Acquire**, **Scan**, **Import New Object**, or **Insert**. If you are unsure whether the program is compliant or what the option is, see the documentation for that program.

1. Start the scanning software, and then select the ISIS or TWAIN data source.
2. Select the settings that are appropriate for the documents that you are scanning.
3. Carry out the appropriate actions to complete the scan.

For more information, see the online help for the scanning software.

3 Useful scanner features

Experienced document management professionals might be interested in the following scan features. These features are available from any document TWAIN or ISIS application that allows you to modify the scan settings in its user interface.

- [Work with scan profiles](#)
- [Scan extra long documents](#)
- [Reduce file size with hardware compression](#)
- [Filter out color from a document \(color dropout\)](#)
- [Automatically crop scanned image](#)
- [Automatically detect color](#)
- [Misfeed \(multipick\) detection](#)

Work with scan profiles

Scan profiles provide a fast, efficient way to select the settings for frequently-performed scanning tasks.

- You can use the HP Smart Document Scan Software to set up and modify profiles. These profiles will populate the scanner LCD profile list.
- You can use the HP Scanner Tools Utility to create profiles associated with ISIS- or TWAIN-compliant third-party applications. These profiles will populate the scanner LCD profile list.
- You can use the TWAIN and ISIS interfaces to create profiles for use with third-party software applications. These profiles do not appear on the scanner LCD profile list.

View profiles

To view the existing HP Smart Document Scan Software profiles, follow these steps:

1. Click **Start**, point to **Programs** or **All Programs**, point to **HP**, point to **HP Smart Document Scan**, and then click **HP Smart Document Scan Software**.
2. View the list of profiles.

To view all existing scan profiles, follow these steps:

1. Turn on the scanner and start the HP Scanner Tools Utility.
2. Click the **Profiles** tab.

Create HP Smart Document Scan Software profiles

To create an HP Smart Document Scan Software profile, follow these steps:

1. Click **Start**, point to **Programs** or **All Programs**, point to **HP**, point to **HP Smart Document Scan**, and then click **HP Smart Document Scan Software**.

2. Click **Create new profile**.

The **Create New Profile** dialog box is displayed.

3. In the **Profile name** box, type the name you want or accept the default name.



TIP: You might want to set up the new profile based on an existing one. To do so, select the **Copy settings from profile** check box, and then select an existing profile from the list.

4. Click **Continue**.

The **Profile Settings** dialog box is displayed.

5. Select the settings for the profile.

For more information, see the HP Smart Document Scan Software Help.

Create scan profiles that use third-party scanning software

If you have scanning software that you want to use with your scanner, you can create profiles that use your software.

To create a third-party scan profile, follow these steps:

1. Turn on the scanner and start the HP Scanner Tools Utility.
2. Click the **Profiles** tab.
3. In the **Other application profiles** area, click **Create**.
4. Complete the fields in the **Create/Edit Other Application** dialog box.
 - **Application:** Enter the complete path and filename of the scanning software you want to use, or click **Browse** to locate and select it.
 - **Name:** Enter a name for this profile as you want it to display in the scanner LCD list. You can enter up to 32 characters (16 for double-byte languages such as Chinese and Korean).
 - **Details:** Enter a description of up to 24 characters (12 for double-byte languages).
5. **Command Line for Simplex Button** and **Command Line for Duplex Button:** If your scanning application supports specific command line parameters for scanning, enter them here.
6. When you are done, click **OK**.

 **TIP:** If you later want to edit or delete the third-party profile you created, click either **Edit** or **Delete** in the **Other application profiles** area on the **Profiles** tab.

Import and export HP Smart Document Scan Profiles

Profiles can be exported into and imported from an XML file so that administrators can set up profiles for a workgroup, users can transfer their profiles from one machine to another, and users can share custom profiles with each other.

Scan extra long documents

By default, the HP Smart Document Scan Software accepts a stack of originals up to 216 mm x 356 mm (8.5 in x 14 in). You can choose to scan single pages up to 216 mm x 864 mm (8.5 in x 34 in).

 **NOTE:** If the scanner is set to scan long pages and a page jams, up to 864 mm (34 in) of document pages can be wrinkled as a result of the jam. Therefore, select scan profiles that specify long pages only when you are scanning pages longer than 356 mm (14 in).

To enable long-page scans in an HP Smart Document Scan Software profile, follow these steps:

1. Open the HP Smart Document Scan Software.
2. Select a scan profile, and then click **Edit profile**.

3. On the **Scan** tab of the **Profile Settings** dialog box, click **Page Size**.
4. Select **Custom** in the **Page size** drop-down list, and then type the actual page dimensions, up to 216 mm x 864 mm (8.5 in x 34 in), in the **Width** and **Height** boxes.

 **NOTE:** Use the ISIS or TWAIN user interface to set the page size when scanning from third-party applications.

 **NOTE:** Some scanning and destination software might not support all of the page sizes that the scanner accepts.

 **NOTE:** HP recommends scanning long pages individually at a resolution of 300 dpi or lower.

Reduce file size with hardware compression

The scanner supports multiple levels of JPEG compression to increase the rate of data transfer from the scanner to the scanning software on the computer. The scanner compresses the data during the scanning process. The scanning software can uncompress the data in order to create scanned images. JPEG compression works on grayscale and color scans.

To enable JPEG compression in an HP Smart Document Scan Software profile, follow these steps:

1. Open the HP Smart Document Scan Software.
2. Select a scan profile, and then click **Edit profile**.
3. On the **Scan** tab of the **Profile Settings** dialog box, click **Hardware Options**.
4. Use the **Data transfer** slider to set the level of compression.
 - Higher quality turns off compression, resulting in slower data transmission.
 - Lower quality turns on compression, resulting in faster data transmission.

 **NOTE:** Use the ISIS or TWAIN user interface to control compression when scanning from third-party software.

Filter out color from a document (color dropout)

You can filter out a color channel (red, green, or blue) or up to three individual colors. For specific colors, the sensitivity setting controls how closely a scanned color must approximate the specified color.

Removing colors from the scan might reduce the scan file size and improve optical character recognition (OCR) results.

To select colors to eliminate from a scan in an HP Smart Document Scan Software profile, follow these steps:

1. Open the HP Smart Document Scan Software.
2. Select a scan profile, and then click **Edit profile**.

3. On the **Scan** tab of the **Profile Settings** dialog box, click **Color Dropout**.
4. Under **Color dropout**, specify the color dropout settings.

Only the color dropout options available for your scanner are selectable.

For information about the color dropout settings, see the online help for the scanning software that you are using.

 **NOTE:** The color channel filter only applies to grayscale scans and to black and white scans. Specific color filters apply to all color modes.

 **NOTE:** Use the ISIS or TWAIN user interface to filter out color when scanning from third-party scanning software.

Automatically crop scanned image

To automatically crop a scan, follow these steps:

1. Open the HP Smart Document Scan Software.
2. Select a scan profile, and then click **Edit profile**.
3. Select your crop options.
 - To automatically crop to the content of the document, click the **Image Processing** tab of the **Profile Edit** dialog box, click **Adjust each scanned page**, select the **Crop to content on page** check box, and then click **Crop settings**.
 - To automatically crop to the dimensions of the document, click the **Scan** tab of the **Profile Edit** dialog box, click **Page Size**, and then select the **Crop to paper** check box.

 **NOTE:** Use the ISIS or TWAIN user interface to set crop options when scanning from third-party scanning software.

 **NOTE:** For information about the auto-crop settings, see the online help for the scanning software that you are using.

Automatically detect color

You can use this feature to reduce the size of the scanned file by only saving pages that contain color as color scans, and saving all other pages as black and white.

To automatically detect color in a scanned image, follow these steps:

1. Open the HP Smart Document Scan Software.
2. Select a scan profile, and then click **Edit profile**.
3. On the **Scan** tab of the **Profile Settings** dialog box, click **Image Options**, and then select **Auto color detect** from the **Mode** drop-down list.

 **NOTE:** For information about the automatic color detection settings, see the online help for the scanning software that you are using.

 **NOTE:** Use the ISIS or TWAIN user interface to automatically detect color when scanning from third-party scanning software.

Misfeed (multipick) detection

The Misfeed multipick detection feature stops the scan process if it senses that multiple pages are fed into the scanner at one time. This feature is enabled by default.

You might want to disable this feature if:

- You are scanning multipart forms (a use that HP does not recommend).
- Documents have labels or sticky notes attached to them.

To change this setting in an HP Smart Document Scan Software profile, follow these steps:

1. Open the HP Smart Document Scan Software.
2. Select a scan profile, and then click **Edit profile**.
3. On the **Scan** tab of the **Profile Settings** dialog box, click **Hardware Options**, and then select or clear the **Misfeed (multipick) detection** check box.



TIP: When Misfeed (multipick) detection is enabled, you can exclude a specific region from detection by selecting a region from the **Exclude region for multipick detection** drop-down list.



NOTE: Use the ISIS or TWAIN user interface to enable misfeed detection when scanning from third-party software.

4 Care and maintenance

This section presents information about how to care for and maintain the scanner. For the latest maintenance information, see www.hp.com/support.

- [HP Scanner Tools Utility Maintenance tab](#)
- [Order maintenance and scanning supplies](#)
- [Clean the scanner glass, scanning strip, and automatic document feeder \(ADF\) duplex background](#)
- [Clean the rollers](#)
- [Replace the rollers](#)
- [Replace the separation pad](#)
- [Replace the front panel](#)

Occasional cleaning of the scanner helps ensure high-quality scans. The amount of care necessary depends upon several factors, including the amount of use and the environment. You should perform routine cleaning as necessary.

The scanner software CD which came with your product includes animations which guide you through the following maintenance tasks. These animations are also available at www.hp.com/support.

- Removing and replacing rollers
- Removing and replacing the separation pad
- Removing and replacing the front panel

HP Scanner Tools Utility Maintenance tab

The **Maintenance** tab of the HP Scanner Tools Utility displays the scanner usage, maintenance history, and settings. You can record scanner maintenance and change the setting for maintenance alerts.

For detailed information, see the HP Scanner Tools Utility Help. To open the Help, press the **Tools** (🔧) button on the scanner front panel, and then click **Help** in the dialog box.

Order maintenance and scanning supplies

You can purchase maintenance parts for your scanner.

1. Visit the HP scanner parts Web site at www.hp.com/buy/parts.
2. Select your language, and then click the arrow.

Clean the scanner glass, scanning strip, and automatic document feeder (ADF) duplex background

The scanner glass, scanning strip, and ADF duplex background should be cleaned periodically or any time a scanned image has streaks.

To clean these components, follow these steps:

1. Press the **Power** (⏻) button to turn off the scanner, and then disconnect the USB cable and power supply from the scanner.
2. Open the scanner lid.
3. Clean the scanner glass and scanning strip with a soft, lint-free cloth that has been sprayed with a mild glass cleaner.



⚠ CAUTION: Use only glass cleaner to clean the scanner glass and scanning strip. Avoid cleaners that contain abrasives, acetone, benzene, and carbon tetrachloride, all of which can damage the scanner glass. Avoid isopropyl alcohol because it can leave streaks on the glass.

Do not spray the glass cleaner directly on the scanner glass or scanning strip. If too much glass cleaner is applied, the cleaner could leak under the scanner glass or scanning strip and damage the scanner.

4. Dry the glass with a dry, soft, lint-free cloth.

5. Close the scanner lid, and then raise the scanner input tray until it is perpendicular to the scanner.



6. Press in on the ADF duplex background tabs to release the ADF duplex background, and then pull forward to remove the ADF duplex background from its housing.

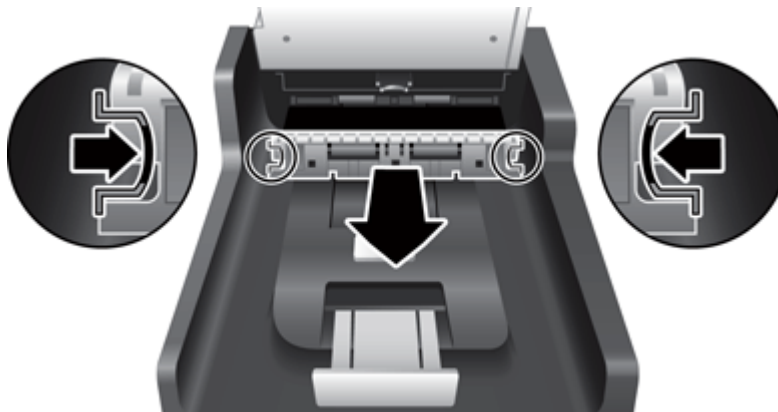

7. Wipe the ADF duplex background with a soft, lint-free cloth that has been moistened with warm water.
8. Dry the ADF duplex background with a dry, soft, lint-free cloth, and then slide the component into its housing until it clicks into place.
9. Lower the scanner input tray into place, and then reconnect the USB cable and power supply to the scanner.

Clean the rollers

Clean the rollers under the following conditions:

- The HP Scanner Tools Utility indicates that cleaning is needed.
- You experience repeated document jams.
- The scanner does not pull pages into the paper path.

- The scanned images are elongated.
- You frequently scan any of the following types of documents: coated paper, chemically treated documents such as carbonless paper, documents with a large amount of calcium carbonate, documents written with pencils, documents on which the toner has not fused.

To clean the rollers, follow these steps:

1. Press the **Power** (⏻) button to turn off the scanner, and then disconnect the USB cable and power supply from the scanner.
2. Open the automatic document feeder (ADF) hatch.

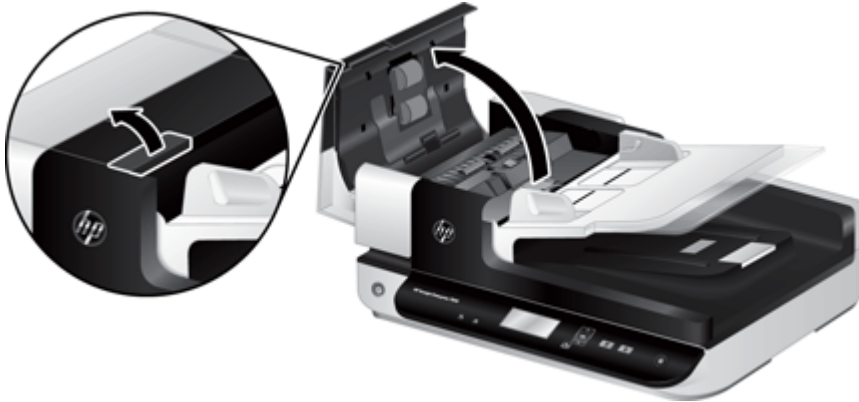

3. Remove any visible lint or dust from each of the feed rollers and the separation pad using compressed air or a clean lint-free cloth moistened with warm water.

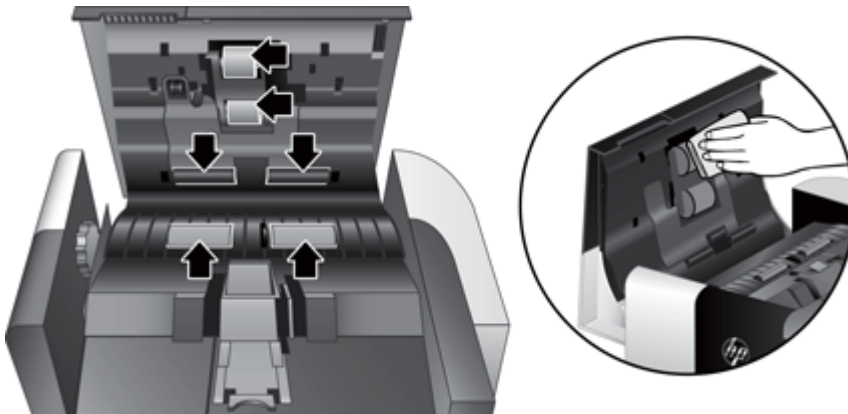

4. Close the ADF hatch, and then reconnect the USB cable and power supply to the scanner.
5. Press the **Power** (⏻) button to turn on the scanner, and then update the scanner maintenance history:
 - a. Press the **Tools** (🔧) button on the scanner front panel to open on the HP Scanner Tools Utility.
 - b. In the **Record Cleaning** section of the **Maintenance** tab, click **Record Cleaning**.
For more information, see the HP Scanner Tools Utility Help.

Replace the rollers

Replace the rollers under the following conditions:

- When the **Maintenance Recommended** dialog box indicates they are due for maintenance.
- If you experience repeated document jams and cleaning the rollers did not help.

 **TIP:** The scanner software CD which came with your product includes an animation which guides you through removing and replacing the rollers. This animation is also available at www.hp.com/support.

The roller replacement kit includes a replacement separation pad. To order the replacement kit, see www.hp.com/buy/parts.

 **NOTE:** The roller replacement kit is a consumable and is not covered under warranty or standard service agreements.

To replace the rollers, follow these steps:

1. Press the **Power** (⏻) button to turn off the scanner, and then disconnect the USB cable and power supply from the scanner.
2. Open the automatic document feeder (ADF) hatch.

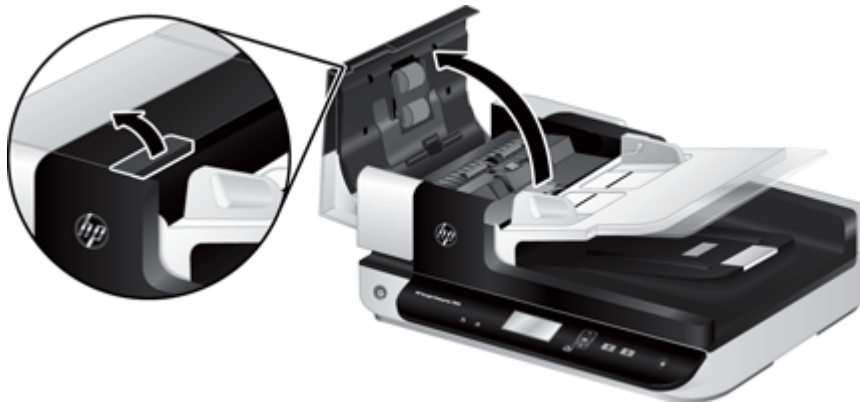

3. Slide your fingertip behind the tab on the roller assembly door, and then pull gently forward and down to open the door.

 **TIP:** Lift the ADF input tray slightly to make it easier to reach the tab.

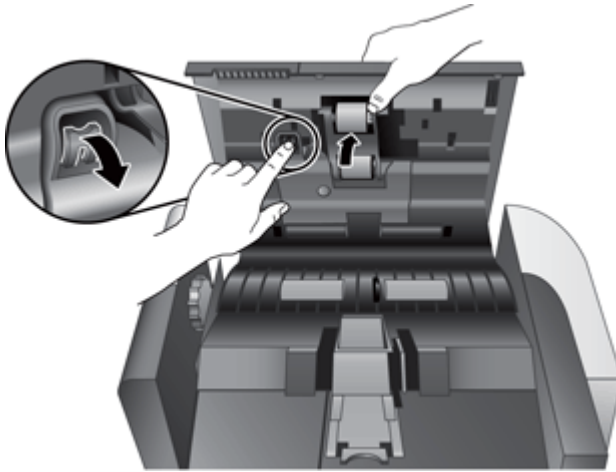

4. Holding the roller assembly door down and out of the way, grasp the roller assembly and slide it to the left to release it from the enclosure.

⚠ CAUTION: Do not touch the rollers with bare fingers, as oils from your fingers could impact performance.

📝 NOTE: You might feel a slight resistance when sliding the roller assembly.

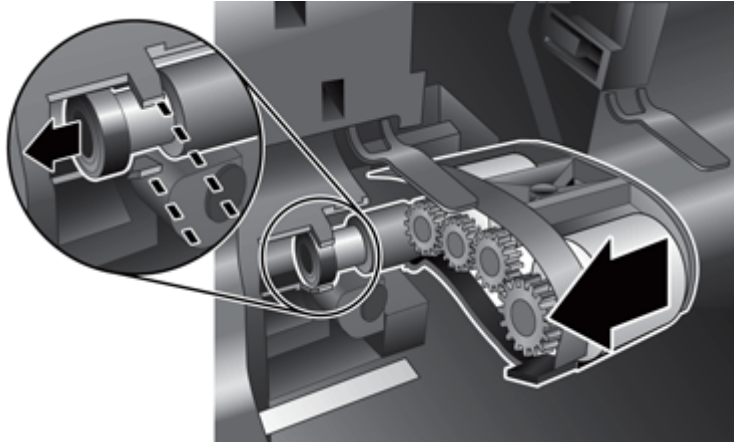

⚠ CAUTION: Take care not to press down on the alignment tabs or against the tab to the right of the roller assembly.

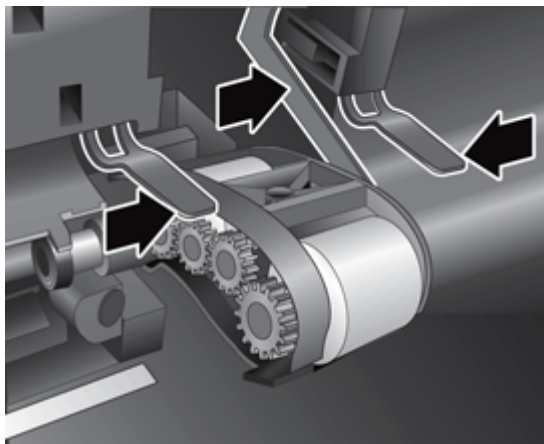

5. Lift the roller assembly out and set it aside.

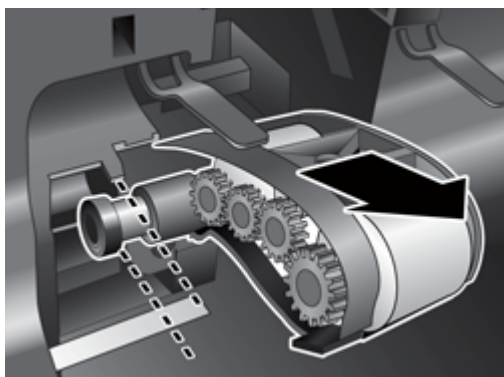

6. Holding the roller assembly door down and out of the way, insert the new roller assembly into the enclosure and slide it to the right until it is seated firmly.

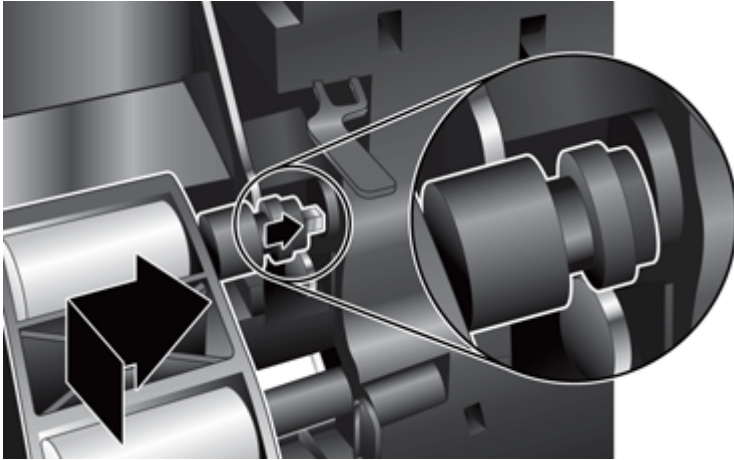

7. Close the roller assembly door, ensuring that the latch seats firmly.

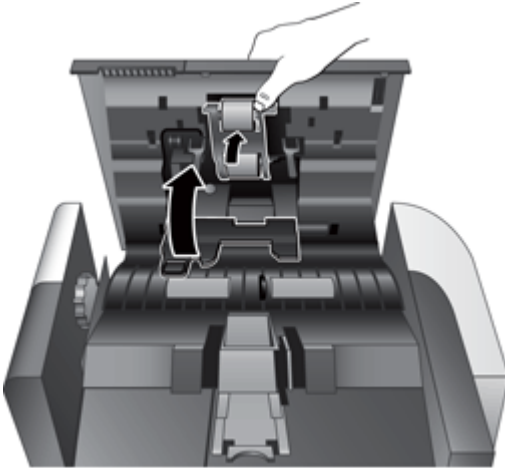

8. Close the ADF hatch, reconnect the USB cable and power supply to the scanner, and then turn on the scanner.
9. Update the scanner maintenance history:
 - a. Press the **Tools** (🔧) button on the scanner front panel to open the HP Scanner Tools Utility.
 - b. In the **Record Replacement** section of the **Maintenance** tab, click **Record Replacement**.For more information, see the HP Scanner Tools Utility Help.



NOTE: HP recommends that you replace the rollers every 100,000 scans.

The HP Scanner Tools Utility can remind you when service is needed, which depends on many conditions and might be sooner than this replacement interval.

Replace the separation pad

The roller replacement kit includes a replacement separation pad. Always replace the separation pad when you replace the rollers. To order the roller replacement kit, see www.hp.com/buy/parts.

 **TIP:** The scanner software CD which came with your product includes an animation which guides you through removing and replacing the separation pad. This animation is also available at www.hp.com/support.

To replace the separation pad, follow these steps:

1. Press the **Power** (⏻) button to turn off the scanner, and then disconnect the USB cable and power supply from the scanner.
2. Open the automatic document feeder (ADF) hatch.

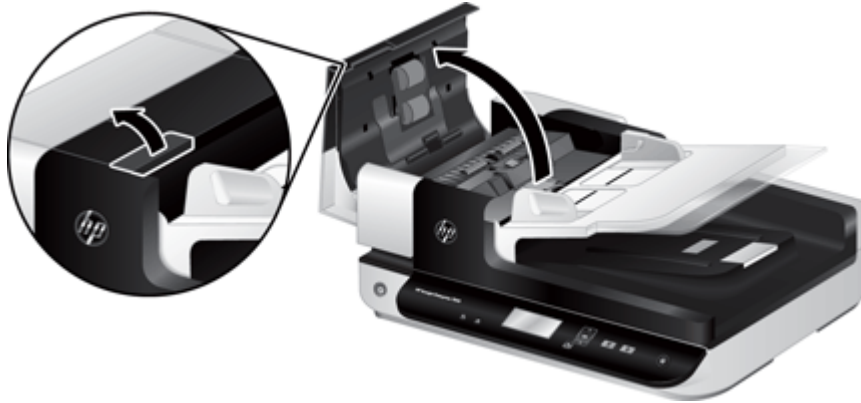

3. Press forward (toward the rear of the ADF) on the separation pad latch to release the separation pad.

 **TIP:** This is easier to do if you raise the ADF input tray slightly.

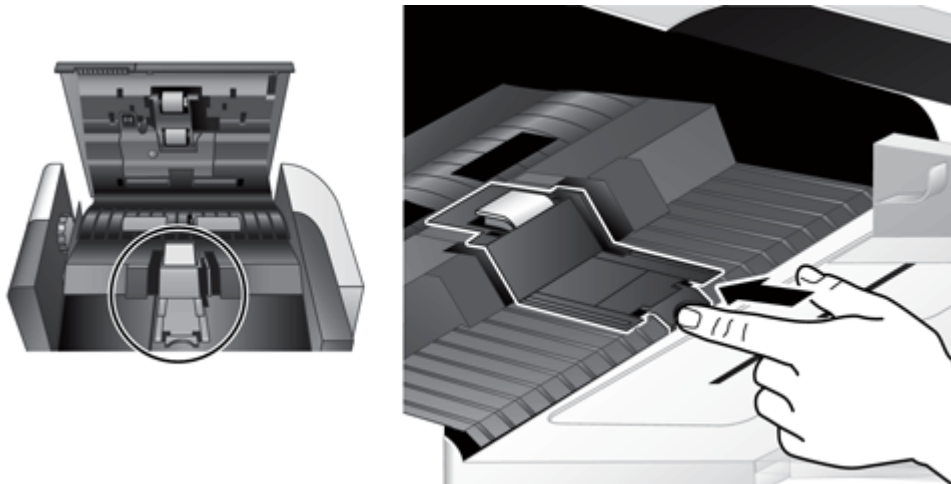

4. Lift up on the separation pad component, release it from its housing, and set it aside.

⚠ CAUTION: Do not touch the pad itself with bare fingers, as oils from your fingers could impact performance.

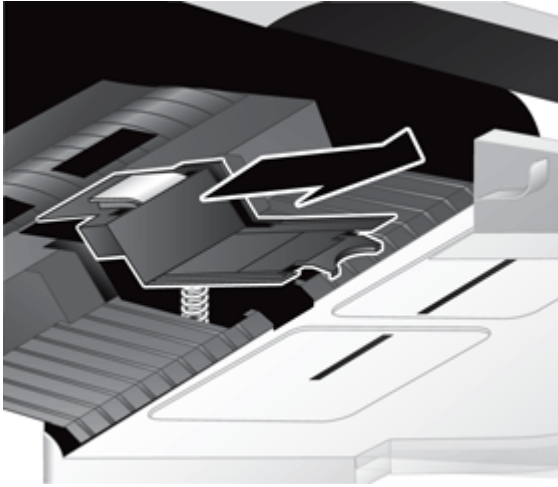

5. Slide the rear edge of the new separation pad component into its housing, ensuring that the spring below the pad is not bent down.

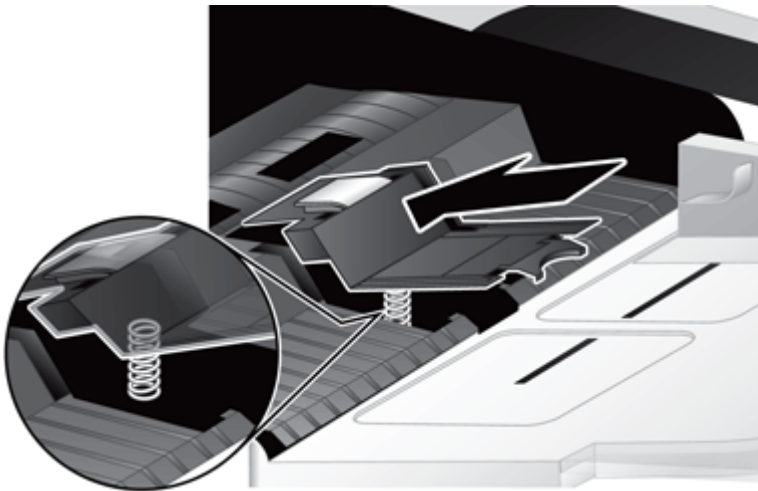

6. Press down on the front portion of the separation pad component until you hear an audible click, indicating that the pad is seated firmly.

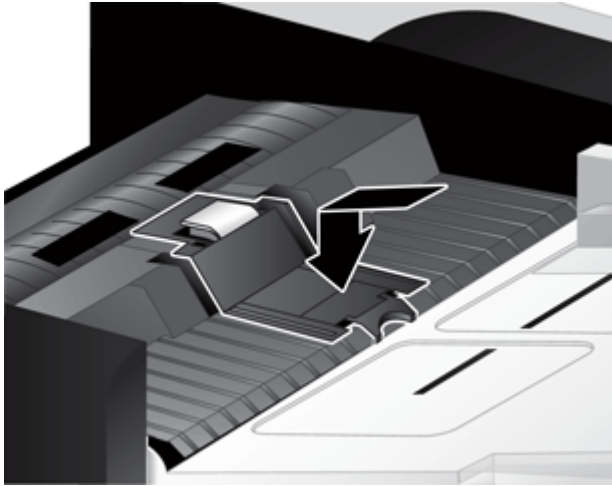

 **TIP:** Taking care not to touch the pad with bare fingers, press down on the pad and then release, ensuring that the pad springs back up. This indicates that the spring below the pad is positioned correctly.

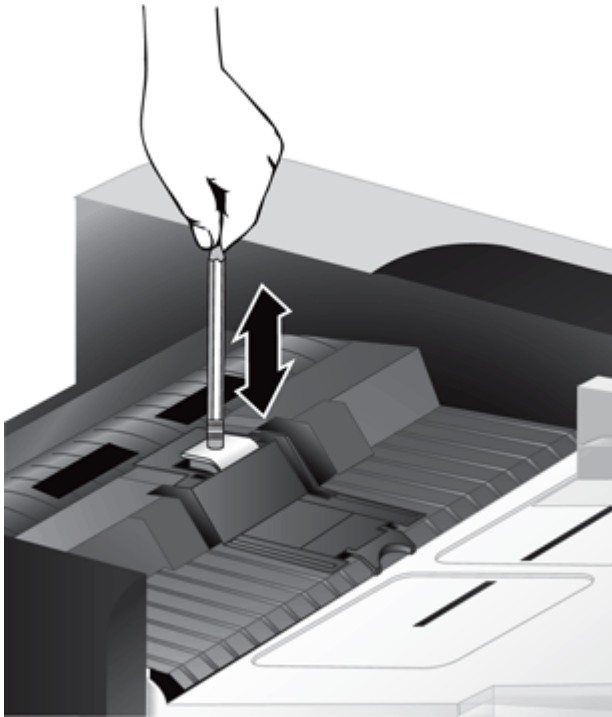

7. Close the ADF hatch, reconnect the USB cable and power supply to the scanner, and then turn on the scanner.

Replace the front panel

 **TIP:** The scanner software CD which came with your product includes an animation which guides you through removing and replacing the front panel. This animation is also available at www.hp.com/support.

To replace the front panel, follow these steps:

1. Press the **Power** (⏻) button to turn off the scanner, and then disconnect the USB cable and power supply from the scanner.
2. Raise the scanner lid.
3. Loosen the front panel cover.
 - a. Locate the access hole on the underside of the front panel, and press the bottom end of a pen upward into the hole.
 - b. While pressing the pen upward, use your fingers to gently pry at the tab location shown, lifting the front panel gently as you release the tab.

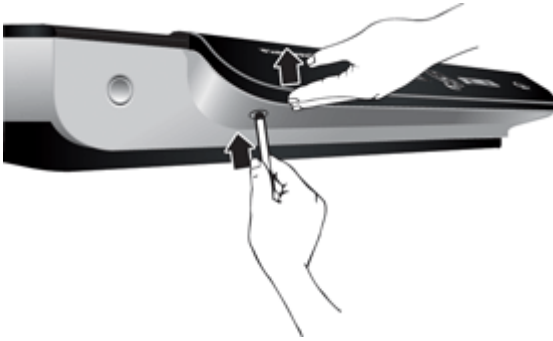

4. Continue to pry at the remaining tab locations, lifting the front panel gently as you release each tab.

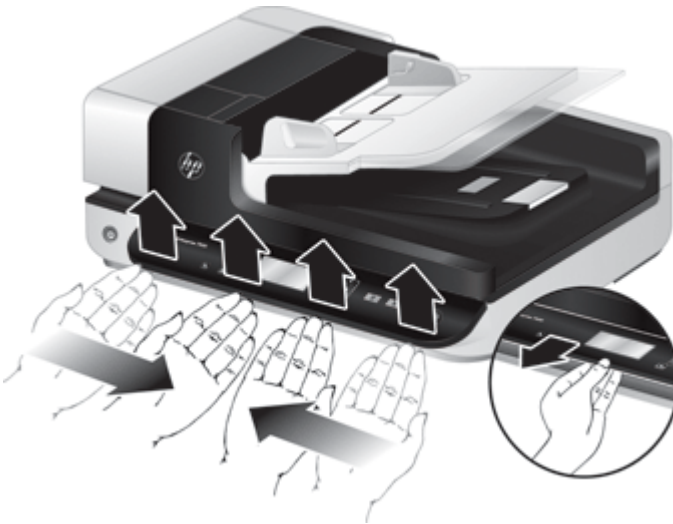

5. Invert the front panel, hold it firmly with one hand, disconnect the 6-pin connector, and set the front panel aside.

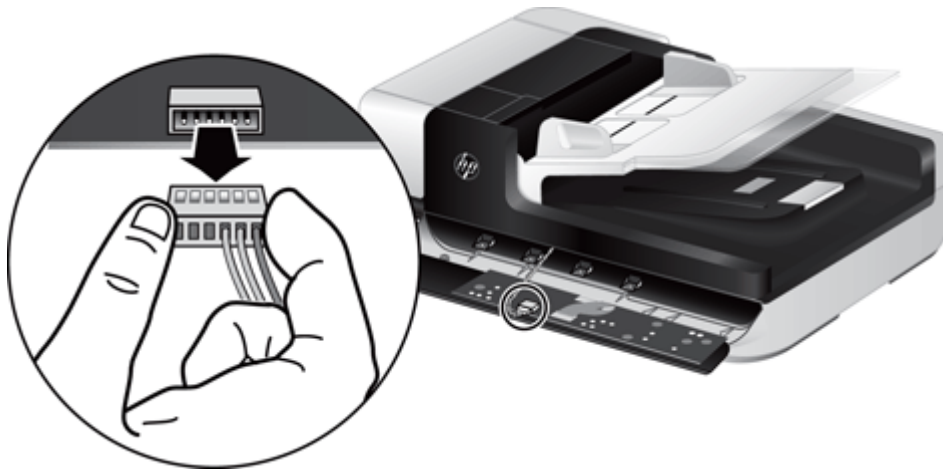

6. Connect the new front panel, taking care to align the notches on the 6-pin connector with the 6-pin receptacle on the front panel.

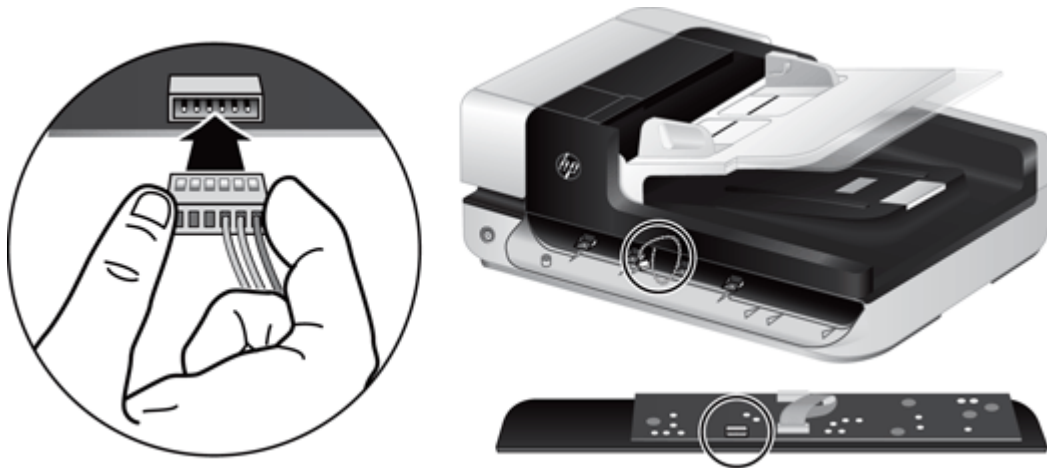

7. Invert the front panel so that it is LCD side up, and position the front panel horizontally to the front panel bezel so the four tabs on the front panel align with the tab slots on the scanner.



8. Gently push the front panel against the bezel (ensuring that the entire front panel is aligned properly), rotate down, and then press down on the front panel to seat it in place.

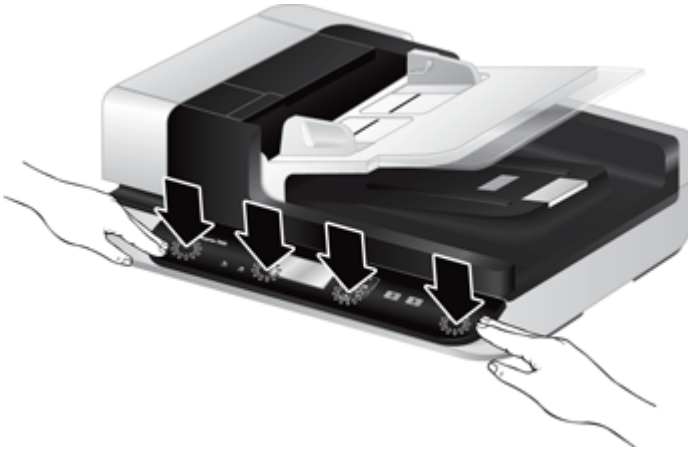

9. Close the scanner lid, reconnect the USB and power cable, and then turn on the scanner.

5 Troubleshooting

This section contains solutions for common problems with the scanner.

- [Scanner errors](#)
- [Basic troubleshooting tips](#)
- [Scanner installation troubleshooting](#)
- [Scanner initialization or hardware problems](#)
- [Scanner operation problems](#)
- [Scanner buttons are not working correctly](#)
- [Scanner paper path problems](#)

For additional troubleshooting, see the Help for the HP scanning program that you are using.

Scanner errors

For help responding to an error, see the appropriate topics below.

Error	Description
USB Error	<ol style="list-style-type: none">1. Check the USB connection between the scanner and the computer.2. Use the Windows Device Manager tool to verify that the computer recognizes the scanner.<ul style="list-style-type: none">◦ Windows XP/XP, 64 bit: The Windows Device Manager tool is available on the Hardware tab of the Systems tool in the Control Panel.◦ Vista/Vista, 64 bit, Windows 7: If you have the categorized Control Panel view, select Control Panel, select Hardware and Sound, and then select Device Manager. If you have the Classic view, select Control Panel, then select Device Manager.3. If the computer does not recognize the scanner, uninstall and then reinstall the scanner software.4. If the problem persists, see www.hp.com/support.
Paper Jam	A document feeder paper jam has been detected. Open the hatch and clear the jam.
Hatch Open	The hatch on the document feeder is open or not securely latched. Please close the hatch by pressing until you hear a click, and then rescan.
Motor Failure	Press the Power (⏻) button to turn off the scanner, wait 30 seconds, and then turn on the scanner. If the message is still displayed, see www.hp.com/support .

Error	Description
Paper Error	<p>The document feeder cannot pick up the paper or the paper is jammed. Follow these steps to resolve the error:</p> <ol style="list-style-type: none"> 1. Remove the paper from the document feeder. 2. Sort through the stack to make sure the sheets are not stuck together. 3. Make sure the paper meets the size and weight specifications, as specified in the scanner User Guide. 4. Verify that the roller assembly and separation pad are installed correctly. 5. Replace the stack of originals and try again.
Hardware Error	<p>A hardware failure occurred. Press the Power (⏻) button to turn off the scanner, wait 30 seconds, and then turn on the scanner. If the message is still displayed, see www.hp.com/support.</p>

Basic troubleshooting tips

Simple issues such as smudges on the scanner glass or loose cables can cause your scanner to produce fuzzy scans, operate in an unexpected manner, or fail to operate. Always check the following items when you encounter scanning problems.

- If scans are fuzzy, check to see if the scanning strip to the left of the scanner glass is dirty or smudged. If so, clean the scanning strip.

If you are scanning a document that will be analyzed using Optical Character Recognition (OCR), make sure that the original document is clear enough to be analyzed.
- Make sure that the USB and power cables are firmly seated in their respective connectors on the back of the scanner, and that the power cord is plugged into a working electrical outlet.
- Ensure that the scanner is receiving power.
 - Check that the green LED on the power supply case is on.
 - If the green LED is not on, ensure that power is available to the power outlet or surge protector that the power supply is plugged into.
 - If power is available to the power outlet or surge protector but the green LED is still not on, the power supply might be defective. Contact www.hp.com/support for assistance.
- If you have connected the scanner to the computer through a USB hub or through a USB port on the front of the computer, disconnect the scanner and then reconnect it to a USB port on the back of the computer.
- Make sure that the scanner buttons are enabled.
- Turn off the scanner, wait 30 seconds, and then turn on the scanner.
- Make sure the automatic document feeder (ADF) hatch is closed.
- Restart the computer.

If you continue to have problems, it is possible that your HP scanning software, firmware, or associated drivers are out of date or have become corrupted. See www.hp.com/support to locate software, firmware, and driver updates for your scanner.

Scanner installation troubleshooting

- [Check the cables](#)
- [Uninstall and then reinstall the HP Scanjet utilities](#)

Check the cables

Cable type	Action
Power cable	<p>The power cable is connected between the scanner and a power outlet.</p> <ul style="list-style-type: none">• Ensure that the power cable is securely connected between the scanner and a live electrical outlet or surge protector.• If the power cable is connected to a surge protector, ensure that the surge protector is plugged into an outlet and turned on.• Press the Power (⏻) button to turn off the scanner, and then turn off the computer. After 30 seconds, turn on the scanner and then turn on the computer, in that order.
USB cable	<p>The USB cable is connected between the scanner and the computer.</p> <ul style="list-style-type: none">• Use the cable that was included with the scanner. Another USB cable might not be compatible with the scanner.• Ensure that the USB cable is securely connected between the scanner and the computer.• If the USB cable is connected to a USB port on the front of the computer, move it to a USB port on the back of the computer. <p>For additional USB troubleshooting information, see www.hp.com/support, select your country/region, and then use the search tool to find USB troubleshooting topics.</p>

Uninstall and then reinstall the HP Scanjet utilities

If checking the scanner cable connections did not solve the problem, the problem might have occurred because of an incomplete installation. Try uninstalling and then reinstalling the HP Scanjet utilities.

1. Press the **Power** (⏻) button to turn off the scanner, and then disconnect the USB cable and power cable from the scanner.
2. Use the **Add/Remove** tool (in Windows Vista and Windows 7, the **Programs and Features** tool) from the **Control Panel** to uninstall the following items:
 - ISIS driver
 - TWAIN driver
 - **HP Scanjet 7500 Utilities**

3. Restart the computer.
4. Use the HP Scanning Software CD that came with the scanner to reinstall the HP Scanjet Drivers and Tools.
5. Reconnect the USB cable and power cable to the scanner, and then press the **Power** (⏻) button to turn on the scanner.

Scanner initialization or hardware problems

- [Check the USB connection](#)
- [Check that the scanner has power](#)
- [Reset the scanner](#)
- [The scanner has stopped working correctly](#)

Check the USB connection

Check the physical connection to the scanner.

- Use the cable that was included with the scanner. Another USB cable might not be compatible with the scanner.
- Ensure that the USB cable is securely connected between the scanner and the computer. The trident icon on the USB cable faces up when the cable is properly connected to the scanner.

If the problem persists after verifying the above items, try the following:

1. Do one of the following tasks depending on how the scanner is connected to the computer:
 - If the USB cable is connected to a USB hub or a docking station for a laptop, disconnect the USB cable from the USB hub or the docking station, and then connect the USB cable to a USB port on the back of the computer.
 - If the USB cable is directly connected to the computer, plug it into a different USB port on the back of the computer.
 - Remove all other USB devices from the computer except for the keyboard and the mouse.
2. Press the **Power** (⏻) button to turn off the scanner, wait 30 seconds, and then turn on the scanner.
3. Restart the computer.
4. After the computer has restarted, try using the scanner.
 - If the scanner works, reconnect any additional USB devices one at a time; try the scanner after connecting each additional device. Disconnect any USB devices that prevent the scanner from working.
 - If the scanner does not work, uninstall and then reinstall the HP Scanjet drivers and utilities.

Check that the scanner has power

The power cable is connected between the scanner and a power outlet.

- Ensure that the power cable is securely connected between the scanner and a live electrical outlet.
- If the power cable is connected to a surge protector, ensure that the surge protector is plugged into an outlet and turned on.
- Ensure that the scanner is receiving power.
 - Check that the green LED on the power supply case is on.
 - If the green LED is not on, ensure that power is available to the power outlet or surge protector that the power supply is plugged into.
 - If power is available to the power outlet or surge protector but the green LED is still not on, the power supply might be defective. Contact www.hp.com/support for assistance.

If the problem persists after verifying the above items, follow these steps:

1. Press the **Power** (⏻) button to turn off the scanner, and then disconnect the power supply from the scanner.
2. Wait 30 seconds.
3. Reconnect the power supply, and then turn on the scanner.

Reset the scanner

If you receive an error message similar to **Scanner initialization failed** or **Scanner not found** when trying to use the scanner, you should reset the scanner.

To reset the scanner, follow these steps:

1. Close the HP Smart Document Scan Software and HP Scanner Tools Utility, if they are open.
2. Press the **Power** (⏻) button to turn off the scanner, and then disconnect the power supply from the scanner.
3. Wait 30 seconds.
4. Reconnect the power supply, and then turn on the scanner.

The scanner has stopped working correctly

If the scanner stops scanning, follow these steps. After each step, start a scan to see if the scanner is working. If the problem persists, proceed with the next step.

1. A cable might be loose. Ensure that both the USB cable and power supply are properly connected.

Use the cable that was included with the scanner. Another USB cable might not be compatible with the scanner.
2. Ensure that the scanner is receiving power.
 - a. Check that the green LED on the power supply case is on.
 - b. If the green LED is not on, ensure that power is available to the power outlet or surge protector that the power supply is plugged into.
 - c. If power is available to the power outlet or surge protector but the green LED is still not on, the power supply might be defective. Contact www.hp.com/support for assistance.
3. Unplug the power cable from the power source, wait 30 seconds, and then plug it back in.
4. Restart your computer.
5. Use the **Add/Remove** tool (in Windows Vista, the **Programs and Features** tool) from the **Control Panel** to uninstall the following applications:
 - ISIS/TWAIN software
 - **HP Scanjet Enterprise 7500 Utilities**
6. Reinstall using the HP Scanning Software CD that came with your scanner.
7. Reconnect the USB cable and power cable to the scanner, and then press the **Power** (⏻) button to turn on the scanner.

Scanner operation problems

- [Scanner will not turn on](#)
- [Scanner keeps turning off](#)
- [The LCD is having display issues or scanner buttons are not working as expected](#)
- [Scanner does not scan right away](#)
- [Scanner scans only one side of a two-sided page](#)
- [Scanned pages are missing at the scan destination](#)
- [Scanned image is fuzzy](#)
- [Scanned pages are out of order at the scan destination](#)
- [Optimize scanning and task speeds](#)
- [The scan is completely black or completely white](#)
- [Scanned images are not straight](#)

- [Vertical white stripes appear on the printed page](#)
- [Vertical colored stripes appear on the printed page](#)
- [Scan files are too large](#)

Scanner will not turn on

If the scanner will not turn on when you press the front panel scanner buttons, check the following:

- The scanner may be turned off. Press the **Power** (⏻) button to turn on the scanner.
- The scanner may have been unplugged. Check to see that the power supply has not become disconnected from the scanner or unplugged from the power source.
- The power supply might not be working.
 - Check that the green LED on the power supply case is on.
 - If the green LED is not on, ensure that power is available to the power outlet or surge protector that the power supply is plugged into.
 - If power is available to the power outlet or surge protector but the green LED is still not on, the power supply might be defective. Contact www.hp.com/support for assistance.

Scanner keeps turning off

By default, the scanner will enter Sleep Mode after 15 minutes of inactivity, and will turn off automatically after two hours of inactivity to conserve power.

To change the defaults, complete these steps:

1. Press the **Tools** (🔧) button to start the HP Scanner Tools Utility.
2. Click the **Settings** tab, and then select the appropriate Sleep Mode and Auto-Off settings.
 - To specify the period of inactivity after which the scanner goes into Sleep Mode, select **15 minutes** or **Never** from the **Sleep: Put the scanner to sleep after:** drop-down list.
 - To specify the period of inactivity after which the scanner automatically turns off, select the appropriate value from the **Auto-Off: Turn off the scanner after:** drop-down list.

The LCD is having display issues or scanner buttons are not working as expected

The following symptoms indicate a problem with the scanner front panel.

- **LCD issues:** The display is blank, or part of the display content is missing.
- **Button issues:** Buttons are unresponsive, or the wrong action occurs when you press a button (for example, you get a single-sided scan when you press the **Scan Duplex** (📄) button).
- **LED issues:** LEDs are not working, or are staying in the wrong state.

If the scanner exhibits any of these problems, contact HP support at www.hp.com/support.

Scanner does not scan right away

Make sure the automatic document feeder (ADF) hatch is closed, and that the scanner is turned on.

Scanner scans only one side of a two-sided page

- When scanning using the scanner buttons, press the **Scan Duplex** (Ⓐ) button.
- When using a scan profile for a third-party application, verify that the application supports duplex scanning.

Scanned pages are missing at the scan destination

When scanning, pages that stick together are scanned as one item. The hidden pages are not scanned.

The misfeed (multipick) detection feature stops the scan if multiple pages are fed into the scanner at one time. To enable misfeed (multipick) detection in an HP Smart Document Scan Software profile, follow these steps:

1. Open the HP Smart Document Scan Software.
2. Select a scan profile, and then click **Edit**.
3. On the **Scan** tab of the **Profile Settings** dialog box, select **Hardware Options**.
4. Select the **Misfeed (multipick) detection** check box.

Scanned image is fuzzy

Verify that the document original is not fuzzy.

Use the Kofax Virtual ReScan Software which shipped with your scanner to process the scanned data. Such software cleans up the image and compresses the data.

Check for any obstructions in the scanner paper path and make sure the paper width guides are positioned appropriately. Try another scan.

Clean the scanning strip to the left of the scanner glass.

Check the JPEG compression setting. If scanner compression is high, scanned data might be lost by the compression.

Scanned pages are out of order at the scan destination

Verify that the page order of the original document is correct before placing it face-up into the document feeder.

Make sure that there are no staples, paper clips, or any other attached material (such as adhesive notes) that may cause the pages to feed incorrectly.

Verify that pages are not stuck together.

Optimize scanning and task speeds

Several settings influence the total time for a scanning job. When you want to optimize scanning performance, consider the following information.

- To optimize performance, make sure your computer meets the recommended system requirements. To view minimum and recommended system requirements, see www.hp.com, select your country/region, search on your scanner model, and then search on **datasheet**.
- In the scanning software, choose the layout setting that matches the orientation of the originals in the document feeder.
- To optimize data transfer from the scanner to the scanning software on the computer, enable scanner hardware (JPEG) compression. Typically, the use of scanner compression reduces the time to complete all color scans and grayscale scans with resolution above 300 dpi. Scanner compression affects the rate of data transfer only and can be used with all output formats.



NOTE: You cannot use scanner compression with black and white originals.

- Saving a scanned image to a searchable format (for example, searchable PDF) takes more time than saving to an image format because the scanned image is analyzed using Optical Character Recognition (OCR). Turn on OCR only when you need a searchable document.



NOTE: For the best OCR results, scanner compression should be set to the minimum compression level or disabled.

- Scanning at a higher resolution than necessary increases scanning time and creates a larger file with no additional benefit. If you are scanning at a high resolution, set the resolution to a lower level to increase scanning speed.

The scan is completely black or completely white

The item might not be placed correctly in the document feeder. Make sure that the item you are trying to scan is placed face up.

Scanned images are not straight

Verify that the document feeder guides are centered on the scanner and set to an appropriate width for the original being scanned. Make sure the paper guides touch the edges of the original.

Vertical white stripes appear on the printed page

The destination printer might be out of toner or ink. Scan a different original to the same printer to see if the issue lies with the printer.

If the second scan has the same problem, try scanning to a different printer.

Vertical colored stripes appear on the printed page

Dust can build up on the scanning strip and cause artifacts in scanned images. Clean the scanning strip (which is to the left of the scanner glass) with a soft, lint-free cloth that has been sprayed with a mild glass cleaner.

Scan files are too large

If the saved scan files are very large, try the following:

- Verify the scan resolution setting:
 - 200 dpi is sufficient for storing documents as images.
 - For most fonts, 300 dpi is sufficient for using optical character recognition (OCR) to create editable text.
 - For Asian fonts and small fonts, 400 dpi is the recommended resolution.

Scanning at a higher resolution than necessary creates a larger file with no additional benefit.

- Color scans create larger files than do black and white scans.
- If you are scanning a large number of pages at one time, consider scanning fewer pages at a time to create more, smaller files.
- Use the Kofax Virtual ReScan Software which shipped with your scanner to process the scanned data. Such software cleans up the image and compresses the data, which can result in a smaller file.

Scanner buttons are not working correctly

After each step, press a button to see if it is working correctly. If the problem persists, proceed with the next step.

1. A cable might be loose. Ensure that the USB cable and the power supply are securely connected.
2. The HP Scanner Tools Utility might have been used to disable the buttons. If so, use the HP Scanner Tools Utility to re-enable the buttons.
3. Turn off the scanner, wait 30 seconds, and then turn the scanner back on.
4. Restart your computer.
5. If the problem persists, the buttons might be disabled outside of the HP Scanner Tools Utility. Try the following procedure:
 - a. Open **Control Panel**, select **Scanners and Cameras** (in Windows 7, select **Hardware and Sound**, and then select **Devices and Printers**), and then select your scanner model from the list.
 - b. Display the scanner properties:
 - **Windows XP and Vista:** Right-click your scanner model, and then click **Properties**.
 - **Windows 7:** Click **Scan Properties**, and then click the **Events** tab.
 - c. Examine the buttons setting for your scanner, and ensure that the **Take No Action** option is not selected.
6. If the problem still persists, there may be a problem with the front panel. Contact HP Support at www.hp.com/support.

Scanner paper path problems

- [Paper jamming, skewing, misfeeds, or multiple-page feeds](#)
- [Scanning fragile originals](#)
- [Paper does not feed from the scanner](#)
- [Originals are curling up in the scanner output tray.](#)
- [The bottom of the scanned image is cut off](#)
- [The scanned images have streaks or scratches](#)
- [An item loaded in the scanner jams repeatedly](#)
- [Clear jams from the scanner paper path](#)

Paper jamming, skewing, misfeeds, or multiple-page feeds

- Check that all rollers are in place and that the roller doors and automatic document feeder (ADF) hatch are closed.
- If the pages look skewed as they feed into the scanner paper path, check the resulting scanned images in the software to ensure that they are not skewed.
- The pages might not be placed correctly. Straighten the pages and adjust the paper guides to center the stack.
- The paper guides must be touching the sides of the paper stack to work properly. Please ensure that the paper stack is straight and the guides are against the paper stack.
- The document feeder or output tray might contain more than the maximum number of pages. Load fewer pages in the document feeder, and remove pages from the output tray.
- Clean the scanner paper path to help reduce misfeeds. If misfeeds still occur, clean the rollers. If misfeeds still occur, replace the rollers.

Scanning fragile originals

To safely scan fragile originals (photographs or documents on wrinkled or very lightweight paper) place originals on the scanner glass. Do not use the automatic document feeder (ADF).

Paper does not feed from the scanner

Reload the pages into the document feeder, ensuring that they make contact with the rollers.

The automatic document feeder (ADF) hatch might not be securely latched. Open the ADF hatch and then close it by pressing firmly.

A problem with the scanner hardware might exist. Follow this procedure to test the scanner:

1. Ensure that the power supply is securely connected between the scanner and a live electrical outlet or surge protector. Check that the green LED on the power supply case is on to verify that the power supply is functional.
2. If the power supply is connected to a surge protector, ensure that the surge protector is plugged into an outlet and turned on.
3. Disconnect the power supply from the scanner and turn off the computer. After 30 seconds, reconnect the power supply to the scanner and then turn on the computer, in that order.
4. Try to rescan.

Originals are curling up in the scanner output tray.

Under dry conditions, lightweight originals such as those printed on carbonless copy paper may curl in the output tray. To minimize curl, flatten curled edges on the originals before placing them in the document feeder. If you cannot flatten curled edges, make sure the curled edges are facing down when you place the originals in the document feeder.

The bottom of the scanned image is cut off

By default, the scanning software can scan media that is up to 356 mm (14 in) long. For longer pages, the end of the document is not included in the scanned image.

Verify that you have specified an appropriate page size in the scanning software.

The scanned images have streaks or scratches

After each step, try another scan to see if the streaks or scratches are still apparent. If so, then try the next step. For information on cleaning the scanner, see the **Care and maintenance** section.

- Check that the originals are clean and unwrinkled.
- Clean the scanning strip, which is to the left of the scanner glass.
- Clean the rollers manually.

An item loaded in the scanner jams repeatedly

- The item might not meet the guidelines for acceptable originals.
- The item might have something on it, such as staples or self-adhesive notes on the original that must be removed.
- Make sure the paper guides touch the edges of the original.

Clear jams from the scanner paper path

To clear a paper jam:

1. Open the automatic document feeder (ADF) hatch.

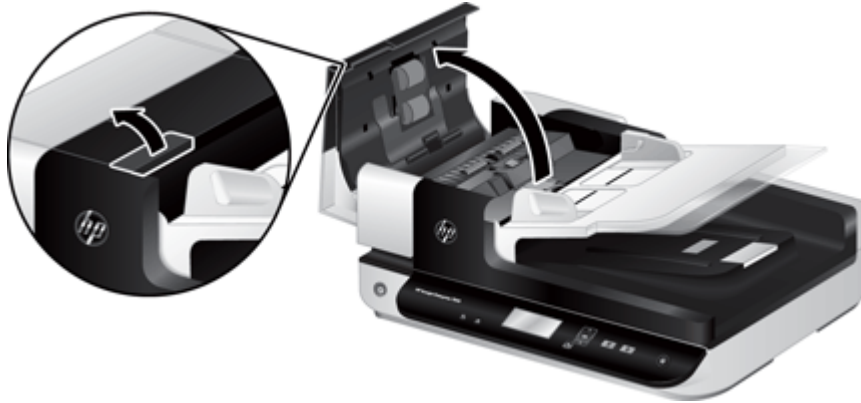

2. Remove the originals or any obstructions from the paper path.

 **TIP:** Use the green thumb wheel on the left side of the open hatch to manually advance originals through the paper path.

3. Remove the ADF duplex background, remove any debris, and then slide the component back into its housing until it clicks into place.

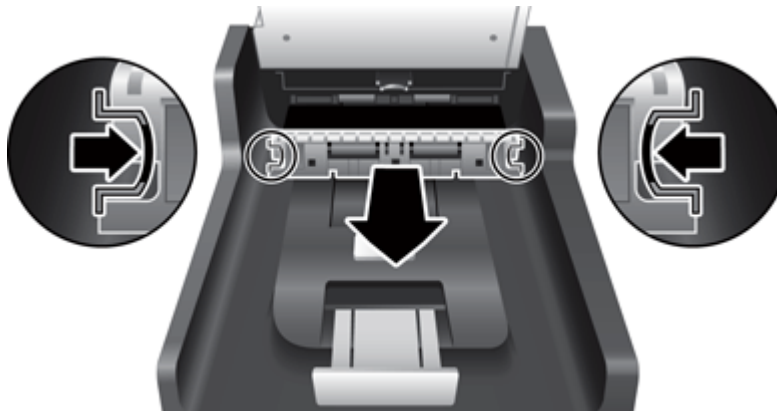

4. Close the ADF hatch until it snaps into place.
5. Reload the unscanned originals in the document feeder.
6. Resume scanning.

6 Product accessibility and support

Accessibility options on this scanner include an LCD Reader and the ability to enable and disable scanner buttons.

- [LCD Reader](#)
- [Control of the scanner buttons](#)

LCD Reader

The LCD Reader is software that outputs the status of the LCD on the scanner front panel to the computer monitor as the LCD changes. The LCD Reader enables accessibility software tools to express what is being shown on the scanner front panel.

To use the LCD Reader, follow these steps:

1. On your hard drive, navigate to C:\Program Files\Common Files\Hewlett-Packard\Scanjet\, and then to the **7500** directory.
2. To open the program, double-click **hplcd.exe**.

 **NOTE:** The LCD Reader is not able to display the LCD text when there is a USB connection error or the scanner is off.

Control of the scanner buttons

To prevent buttons from being pushed accidentally, you can disable the buttons on the scanner front panel.

When the buttons are disabled, you always start scans and copies from the computer using scanning software. You can still press the **Cancel (X)** button on the scanner front panel to stop a scan.

To turn off the scanner buttons, follow these steps:

1. Open the HP Scanner Tools Utility.
2. On the **Profiles** tab, select the **Disable front panel buttons** check box.

To turn on the scanner buttons, clear the **Disable front panel buttons** check box.

 **NOTE:** You must have administrative privileges on the computer to change the setting of this check box.

7 Specifications and warranty

This section contains regulatory information and product specifications for your scanner.

- [Scanner specifications](#)
- [Document feeder specifications](#)
- [Environmental specifications](#)
- [Regulatory information](#)
- [Energy information](#)
- [Disposal of Waste Equipment by Users in Private Households in the European Union](#)
- [Hewlett-Packard limited warranty statement](#)

Scanner specifications

Name	Description
Scanner type	Flatbed with automatic document feeder (ADF)
Size	Width: 570 mm (20.35 in), Depth: 434.6 mm (17.1 in), Height: 206.6 mm (8.14 in)
Weight	10.6 kg (23.37 lbs)
Scanning element	Charge-coupled device (CCD)
Interface	USB 2.0 high speed (compatible with USB 1.1)
Optical resolution	600 x 600 dpi hardware
AC power	<ul style="list-style-type: none">• AC input for power supply: 100V–240V~, 50/60Hz, 1300mA• DC output for power supply: 32 Vdc, 1560mA, 50W
Power consumption	For power consumption information, see the regulatory_supplement.pdf file on the HP Scanning Software CD.
System requirements	To view minimum and recommended system requirements, go to www.hp.com , select your country/region, search on your scanner model, and then search on datasheet .

Document feeder specifications

Name	Description
Paper tray capacity	100 sheets of 75g/m ² (20 lb)
Minimum paper size	68 x 148 mm (2.7 x 5.8 in)
Maximum paper size	216 x 864 mm (8.5 x 34 in)

Name	Description
Minimum paper weight	49 g/m ² (13 lb)
Maximum paper weight	120 g/m ² (32 lb)

Environmental specifications

Name	Description
Temperature	Operating the scanner: 10° to 35° C (50° to 95° F)
	Storage: -40° to 65° C (-40° to 149° F)
Relative humidity	Operating the scanner: 10% to 80% noncondensing 10° to 35° C (50° to 95° F)
	Storage: up to 90% at 0° to 65° C (32° to 149° F)

 **NOTE:** In the presence of high electromagnetic fields, it is possible the output from the HP scanner may be slightly distorted.

 **NOTE:** HP is committed to providing our customers with information about the chemical substances in our products as needed to comply with legal requirements such as REACH (Regulation EC No 1907/2006 of the European Parliament and the Council). A chemical information report for this product can be found at www.hp.com/go/reach.

Regulatory information

Regulatory Model Identification Number: For regulatory identification purposes your product is assigned a Regulatory Model Number. The Regulatory Model Number for your product is FCLSD-1004. This regulatory number should not be confused with the marketing name (HP Scanjet Enterprise 7500/Flow 7500) or product number (L2725A/L2725B). Additional regulatory information about your scanner can be found on the regulatory_supplement.pdf file on the HP Scanning Software CD.

Energy information

Hewlett-Packard printing and imaging equipment marked with the ENERGY STAR® logo is qualified to the U.S. Environmental Protection Agency's ENERGY STAR specifications for imaging equipment. The following mark will appear on ENERGY STAR qualified imaging products:



Additional ENERGY STAR qualified imaging product model information is listed at: <http://www.hp.com/go/energystar>

Disposal of Waste Equipment by Users in Private Households in the European Union



This symbol on the product or on its packaging indicates that this product must not be disposed of with your other household waste. Instead, it is your responsibility to dispose of your waste equipment by handing it over to a designated collection point for the recycling of waste electrical and electronic equipment. The separate collection and recycling of your waste equipment at the time of disposal will help to conserve natural resources and ensure that it is recycled in a manner that protects human health and the environment. For more information about where you can drop off your waste equipment for recycling, please contact your local city office, your household waste disposal service or the shop where you purchased the product.

Hewlett-Packard limited warranty statement

HP Scanjet Enterprise 7500/Flow 7500 scanner

Model	Asia/Pacific	Americas	Europe/Middle East/Africa
7500/Flow 7500	1 year	1 year	1 year

1. HP warrants to you, the end-user customer, that HP hardware, accessories, and supplies will be free from defects in materials and workmanship after the date of purchase, for the period specified above. If HP receives notice of such defects during the warranty period, HP will, at its option, either replace or repair products which prove to be defective. Replacement products may be either new or equivalent in performance to new.
2. HP warrants to you that HP software will not fail to execute its programming instructions after the date of purchase, for the period specified above, due to defects in material and workmanship when properly installed and used. If HP receives notice of such defects during the warranty period, HP will replace software which does not execute its programming instructions due to such defects.
3. HP does not warrant that the operation of HP products will be uninterrupted or error free. If HP is unable, within a reasonable time, to repair or replace any product to a condition as warranted, you will be entitled to a refund of the purchase price upon prompt return of the product.
4. HP products may contain remanufactured parts equivalent to new in performance or may have been subject to incidental use.
5. This warranty does not apply to defects resulting from (a) improper or inadequate maintenance or calibration, (b) software, interfacing, parts, or supplies not supplied by HP, (c) unauthorized modification or misuse, (d) operation outside of the published environmental specifications for the product, or (e) improper site preparation or maintenance.
6. TO THE EXTENT ALLOWED BY LOCAL LAW, THE ABOVE WARRANTIES ARE EXCLUSIVE AND NO OTHER WARRANTY OR CONDITION, WHETHER WRITTEN OR ORAL, IS EXPRESSED OR IMPLIED, AND HP SPECIFICALLY DISCLAIMS ANY IMPLIED WARRANTIES OR

CONDITIONS OF MERCHANTABILITY, SATISFACTORY QUALITY, AND FITNESS FOR A PARTICULAR PURPOSE. Some countries/regions, states, or provinces do not allow limitations on the duration of an implied warranty, so the above limitation or exclusion might not apply to you. This warranty gives you specific legal rights, and you might also have other rights that vary from country/region to country/region, state to state, or province to province.

7. HP's limited warranty is valid in any country/region or locality where HP has a support presence for this product and where HP has marketed this product. The level of warranty service you receive may vary according to local standards. HP will not alter the form, fit, or function of the product to make it operate in a country/region in which it was never intended to function for legal or regulatory reasons.

8. TO THE EXTENT ALLOWED BY LOCAL LAW, THE REMEDIES IN THIS WARRANTY STATEMENT ARE YOUR SOLE AND EXCLUSIVE REMEDIES. EXCEPT AS INDICATED ABOVE, IN NO EVENT WILL HP OR ITS SUPPLIERS BE LIABLE FOR LOSS OF DATA OR FOR DIRECT, SPECIAL, INCIDENTAL, CONSEQUENTIAL (INCLUDING LOST PROFIT OR DATA), OR OTHER DAMAGE, WHETHER BASED IN CONTRACT, TORT, OR OTHERWISE. Some countries/regions, states, or provinces do not allow the exclusion or limitation of incidental or consequential damages, so the above limitation or exclusion may not apply to you.

9. THE WARRANTY TERMS CONTAINED IN THIS STATEMENT, EXCEPT TO THE EXTENT LAWFULLY PERMITTED, DO NOT EXCLUDE, RESTRICT, OR MODIFY AND ARE IN ADDITION TO THE MANDATORY STATUTORY RIGHTS APPLICABLE TO THE SALE OF THIS PRODUCT TO YOU.

Index

A

- accessibility 47
- ADF
 - clean duplex background 20
 - load paper 7
- applications
 - scan from 12
- Auto color detect 17
- automatically crop scanned image 17

B

- Back button 2
- black scans
 - troubleshoot 41
- blurry images 40
- buttons
 - power 1
 - scanner front panel 1

C

- cables
 - troubleshoot 35
- Cancel button 2
- clean
 - ADF 20
 - rollers 21
 - scanner glass 20
 - scanning strip 20
- Color dropout 16
- colored stripes
 - troubleshoot 41
- crooked images 41
- crop scanned image 17
- cut-off images
 - troubleshoot 44

D

- disable scanner buttons 47
- display problems 39
- document feeder
 - load paper 9
 - tips on loading 7

E

- environmental specifications 50
- export profiles 15

F

- features
 - auto color detect 17
 - automatically crop scanned image 17
 - color dropout 16
 - long-page support 15
 - Misfeed (multipick) detection 18
 - scan profiles 13
 - scanner JPEG compression 16
- feed rollers
 - replace 23
- feeding problems 43
- fragile items, scanning 43
- front panel
 - replace 29
- fuzzy images 40

G

- glass, clean 20

H

- hardware compression 16
- HP Scanner Tools Utility
 - Maintenance tab 19
 - uses for 5
- HP Smart Document Scan Software
 - about 3
 - scan from 12
- humidity specifications 50

I

- import profiles 15
- install software
 - troubleshoot 35

J

- jams
 - troubleshoot 44

L

- LCD problems 39
- LCD Reader 47
- lines
 - troubleshoot 41
- long-page support 15

M

- maintenance
 - clean rollers 21
 - HP Scanner Tools Utility
 - Maintenance tab 19
- manage power settings 5, 39
- media
 - jams 44
 - misfeeds 43
 - not feeding 43
 - troubleshoot 43
- misfeeds
 - troubleshoot 43
- multipick detection 18
- multiple-page feeds 43

O

- OK/select button 2
- operating environment
 - specifications 50
- order
 - roller replacement kit 23
 - supplies 19

P

- pages missing, troubleshoot 40
- pages out of order 40
- paper
 - jams 44
 - misfeeds 43
 - not feeding 43
 - troubleshoot 43
- paper-path
 - feeding problems 43

- parts
 - order 23
- power management 5, 39
- power supply
 - troubleshoot cable 35
- problems with LCD 39
- product support 47
- profiles
 - import and export 15
- programs
 - scan from 12
- R**
- reduce file size 16
- replace
 - front panel 29
 - rollers 23
 - separation pad 26
- reset scanner 37
- rollers
 - clean 21
 - replace 23
- S**
- scan
 - feeding problems 43
 - files too large 42
 - fragile items 43
 - from HP Smart Document Scan Software 12
 - from other programs 12
 - paper originals 9
- scan profiles 13
- scanner
 - front panel 1
 - power use 5
 - reset 37
 - specifications 49
- scanner glass
 - load original 10
- scanner hardware compression 16
- scanning strip, clean 20
- screen reader 47
- separation pad
 - replace 26
- skewed images 41
- software
 - troubleshoot installation 35
 - uninstall and reinstall 35, 38
- specifications
 - document feeder 49
 - environmental 50
 - scanner 49
- speed
 - troubleshoot 40
- speed, troubleshoot 41
- storage specifications 50
- streaks
 - troubleshoot 44
- stripes
 - troubleshoot 41
- supplies
 - order 19
- support 47
- T**
- temperature specifications 50
- troubleshoot
 - basic tips 34
 - black scans 41
 - cables 35
 - check power 37
 - colored lines 41
 - crooked images 41
 - cut-off images 44
 - feeding problems 43
 - fragile items 43
 - fuzzy images 40
 - installation 35
 - jams 44
 - large scan files 42
 - misfeeds 43
 - page order 40
 - pages missing 40
 - paper not feeding 43
 - power 39
 - reset scanner 37
 - scanning fragile items 43
 - speed 40, 41
 - stops working 38
 - streaks 44
 - two-sided scans 40
 - uninstall and reinstall software 35, 38
 - white lines 41
 - white scans 41
- troubleshooting
 - buttons 39
- display 39
- LCD 39
- turn on scanner
 - troubleshoot 39
- TWAIN-compliant programs
 - scan from 12
- two-sided scans
 - troubleshoot 40
- U**
- uninstall and reinstall software 35, 38
- USB cable
 - troubleshoot 35
- V**
- vertical colored stripes
 - troubleshoot 41
- vertical white stripes
 - troubleshoot 41
- W**
- Web sites
 - order supplies 19
 - replacement parts 23
- white scans
 - troubleshoot 41
- white stripes
 - troubleshoot 41
- Z**
- zonal multipick detection 18

