

User Manual



**Centurion Tower
PSCE1000/2000/3000
Online UPS
Uninterruptible Power Supply System**



NetGuard[®]

UPS Monitoring Software

IMPORTANT

Download the latest NetGuard Monitoring Software:

www.powershield.com.au/index.php/downloads

Default password is: administrator

Introduction

Thank you for choosing PowerShield.

PowerShield Centurion UPS series are designed to provide the highest level of protection against disturbances found on electrical power supply lines. It is suitable for most applications including IT, security, telephone, broadcasting, medical*¹ etc.

The Centurion UPS series are designed to provide the most comprehensive protection for your valuable electronic equipment, hardware, software and data from harmful disturbances found on AC power lines including blackouts, power sags, power surges, under voltage, over voltage, line noise, frequency variation, switching transients and harmonic distortions. The Centurions true online double conversion topology will continuously protect your equipment by internally isolating your equipment from the utility power ensuring that all your equipment always receives clean, uninterrupted and stable power.

Very Important !! : WARRANTY REGISTRATION

In order to validate product warranty, it is essential that you register your UPS on line.

Please Visit PowerShield on line product warranty web page

www.powershield.com.au/product-registration.php

This user manual contains instructions relating to safety, installation, operation, maintenance and warranty of this product.

Please keep this manual in a safe place for future references.

Handling Safety

 Do not lift heavy loads without assistance.



<18 kg



18–32 kg



32–55 kg



>55 kg

This equipment is intended for installation in a controlled temperature indoor area free from conductive contaminants.

*1: PowerShield does not recommend to use any of its products in life support application and /or in direct patients care.

Table of Contents

1. Important Safety Warning	3
1-1. Transportation	3
1-2. Preparation	3
1-3. Installation	3
1-4. Operation	4
1-5. Maintenance, service and faults	4
2. Installation and setup	5
2-1. Rear panel view	5
2-2. Setup the UPS	7
3. Operations	10
3-1. Button operation	10
3-2. LCD Panel	11
3-3. Audible Alarm	12
3-4. LCD display wordings index	12
3-5. UPS Setting	13
3-6. Operating Mode Description	16
3-7. Faults Reference Code	16
3-8. Warning indicator	17
4. Troubleshooting	18
5. Service	20
6. Storage and Maintenance	21
7. Contact PowerShield	21
8. Product Specification	22

1. Important Safety Warning

Please comply with all warnings and operating instructions in this manual. Save this manual properly and read carefully the following instructions before installing the unit. Do not operate this unit before reading through all safety information and operating instructions carefully

1-1. Transportation

- Please transport the UPS system only in the original package to protect against shock and impact.

1-2. Preparation

- Condensation may occur if the UPS system is moved directly from cold to warm environment. The UPS system must be absolutely dry before being installed. Please allow at least two hours for the UPS system to acclimate to the environment.
- Do not install the UPS system near water or in moist environments.
- Do not install the UPS system where it would be exposed to direct sunlight or near heater.
- Do not block ventilation holes in the UPS housing.

1-3. Installation

- Do not connect appliances or devices which would overload the UPS system (e.g. laser printers) to the UPS output sockets.
- Place cables in such a way that no one can step on or trip over them.
- Do not connect domestic appliances such as hair dryers to UPS output sockets.
- The UPS can be operated by any individuals with no previous experience.
- Connect the UPS system only to an earthed shockproof outlet which must be easily accessible and close to the UPS system.
- Please use only VDE-tested, CE-marked mains cable (e.g. the mains cable of your computer) to connect the UPS system to the building wiring outlet (shockproof outlet).
- Please use only VDE-tested, CE-marked power cables to connect the loads to the UPS system.
- Pluggable equipment includes a protective earth conductor that carries the leakage current from the load devices (computer equipment). Total leakage current must not exceed 3.5mA.

1-4. Operation

- Do not disconnect the mains cable on the UPS system or the building wiring outlet (shockproof socket outlet) during operations since this would cancel the protective earthing of the UPS system and of all connected loads.
- The UPS system features its own, internal current source (batteries). The UPS output sockets or output terminals block may be electrically live even if the UPS system is not connected to the building wiring outlet.
- In order to fully disconnect the UPS system, first press the OFF/Enter button to disconnect the mains.
- Prevent no fluids or other foreign objects from inside of the UPS system.

1-5. Maintenance, service and faults

- The UPS system operates with hazardous voltages. Repairs may be carried out only by qualified maintenance personnel.
- **Caution** - risk of electric shock. Even after the unit is disconnected from the mains (building wiring outlet), components inside the UPS system are still connected to the battery and electrically live and dangerous.
- Before carrying out any kind of service and/or maintenance, disconnect the batteries and verify that no current is present and no hazardous voltage exists in the terminals of high capability capacitor such as BUS-capacitors.
- Only persons are adequately familiar with batteries and with the required precautionary measures may replace batteries and supervise operations. Unauthorized persons must be kept well away from the batteries.
- **Caution** - risk of electric shock. The battery circuit is not isolated from the input voltage. Hazardous voltages may occur between the battery terminals and the ground. Before touching, please verify that no voltage is present!
- Batteries may cause electric shock and have a high short-circuit current. Please take the precautionary measures specified below and any other measures necessary when working with batteries:
 - remove wristwatches, rings and other metal objects
 - use only tools with insulated grips and handles.
- When changing batteries, install the same number and same type of batteries.
- Do not attempt to dispose of batteries by burning them. This could cause battery explosion.
- Do not open or destroy batteries. Escaping electrolyte can cause injury to the skin and eyes. It is toxic.
- Please replace the fuse only with the same type and amperage in order to avoid fire hazards.
- Do not dismantle the UPS system.

2. Installation and setup

NOTE: Before installation, please inspect the unit. Be sure that nothing inside the package is damaged. Please keep the original package in a safe place for future use.

NOTE: There are two different types of online UPS: standard and long-run models. Please refer to the following model table.

NOTE : Long Runtime UPS systems do not contain batteries in the UPS system. Battery bank needs to be purchased when Long Runtime model is used.

Model Number	Type	Model Number	Type
PSCE1000/PSCER1000	Standard Runtime	PSCE1000L/PSCER1000L	Long Runtime
PSCE1500/PSCER1500		PSCE1500L/PSCER1500L	
PSCE2000/PSCER2000		PSCE2000L/PSCER2000L	
PSCE3000/PSCER3000		PSCE3000L/PSCER3000L	

2-1. Rear panel view

PSCE1000(L) / PSCE1500(L) TOWER

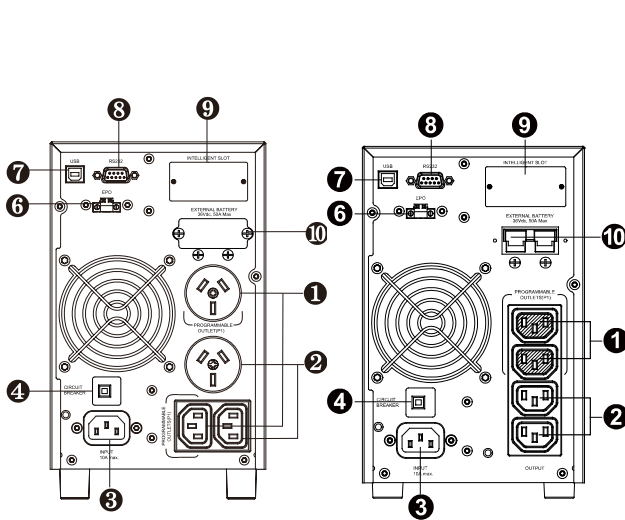

PSCE2000(L) TOWER

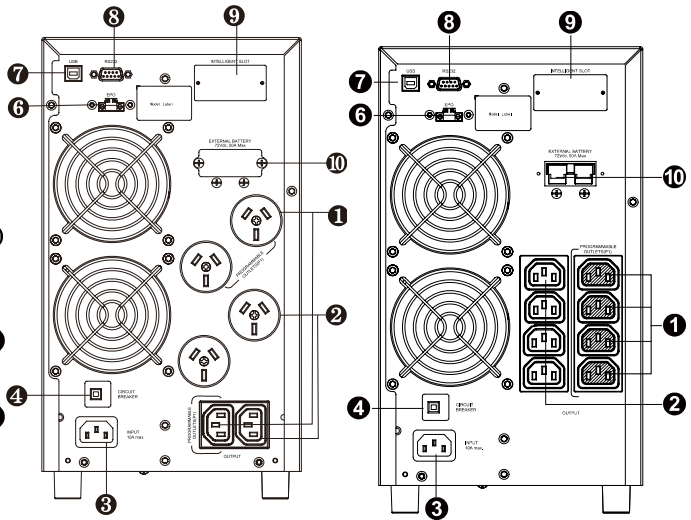

PSCE3000(L) TOWER

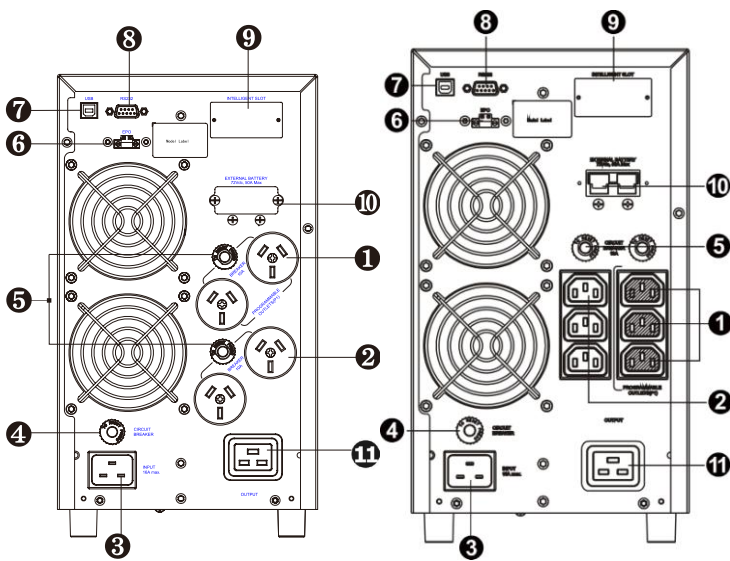

PSCER1000(L)/PSCER1500(L) RACK

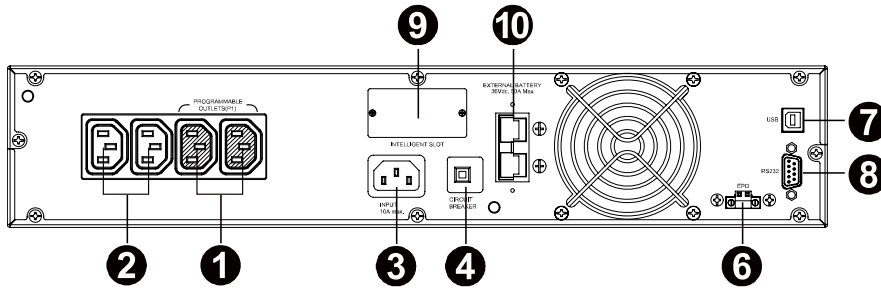

PSCER2000(L) RACK

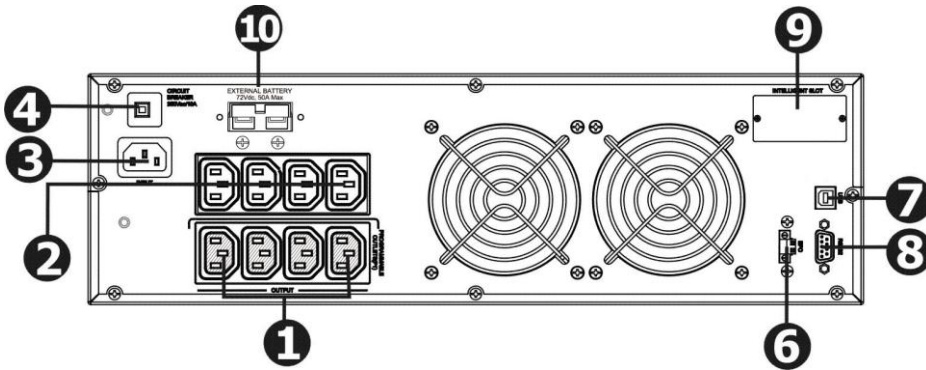

PSCER3000(L) RACK

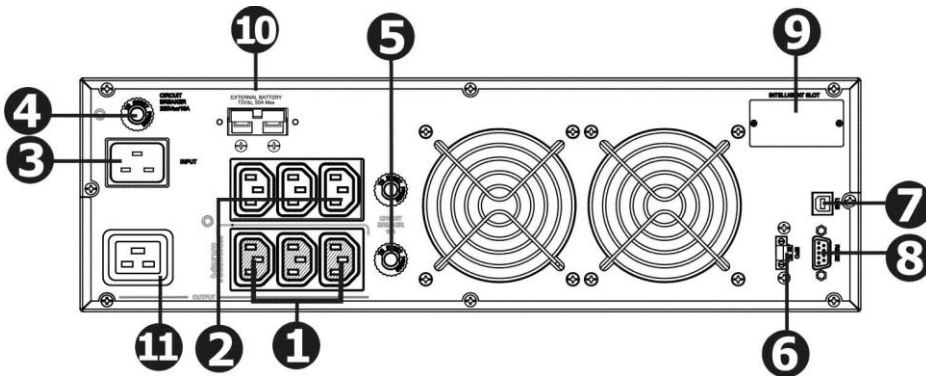

1. Programmable outlets (**WHITE COLOUR OUTLETS**): connect to non-critical loads.
2. General outlets (**BLACK COLOUR OUTLETS**): connect to mission-critical loads.
3. AC input inlet
4. Input circuit breaker
5. Output circuit breaker
6. Emergency power off function connector (EPO)
7. USB communication port
8. RS-232 communication port
9. SNMP /AS400 intelligent slot
10. External battery connection
11. 15A outlet

2-2. Setup the UPS

Step 1: UPS input connection

Plug the UPS input cord into a two-pole, three-wire, grounded receptacle only. Avoid using extension cords.

- Centurion series come with Australian power cord in the package.
For 1000/2000VA : 10A Australian input plug to IEC socket
For 3000VA : 15A Australian input plug to IEC socket

Step 2: UPS output connection

- There are two kinds of outlets on this model: **programmable outlets (Marked in White colour)** and **general outlets(Marked in black colour)**. Please connect non-critical devices to the **programmable outlets** and critical devices to the **general outlets**. During power failure, you may extend the backup time to critical devices by setting shorter backup time for non-critical devices.

Step 3: External Battery Bank connection

- There are external battery banks available on each models for gaining more battery backup time. Please check following instruction for connecting external battery bank to the unit.
- Please provide enough space between UPS and external battery bank for ventilation. Also, do not stack battery banks. Stacking results in a tipping hazard.

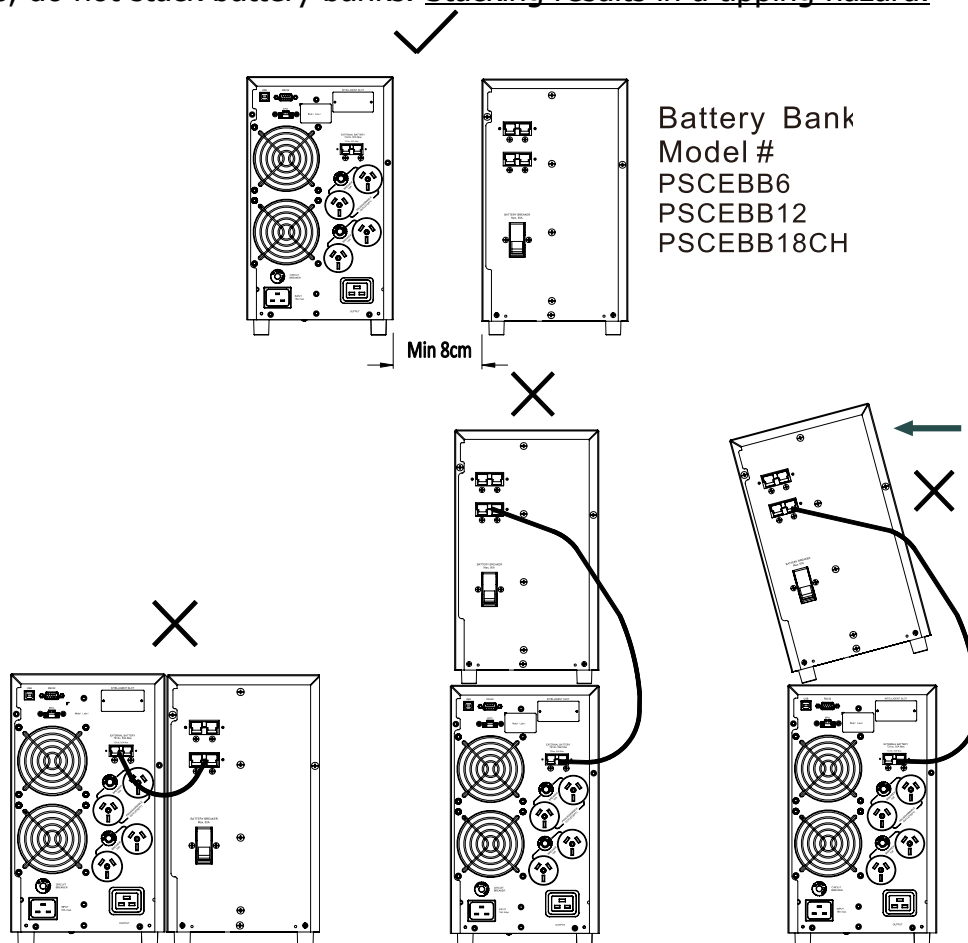

1. Remove DC connector cover from the rear panel of the unit and from the battery bank input connector.

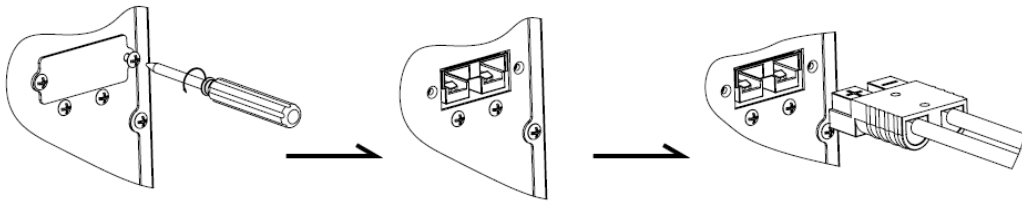

2. Connect DC cable from the DC connector of UPS rear panel to the input DC connector of Battery bank. Turn on battery circuit breaker of Battery banks.

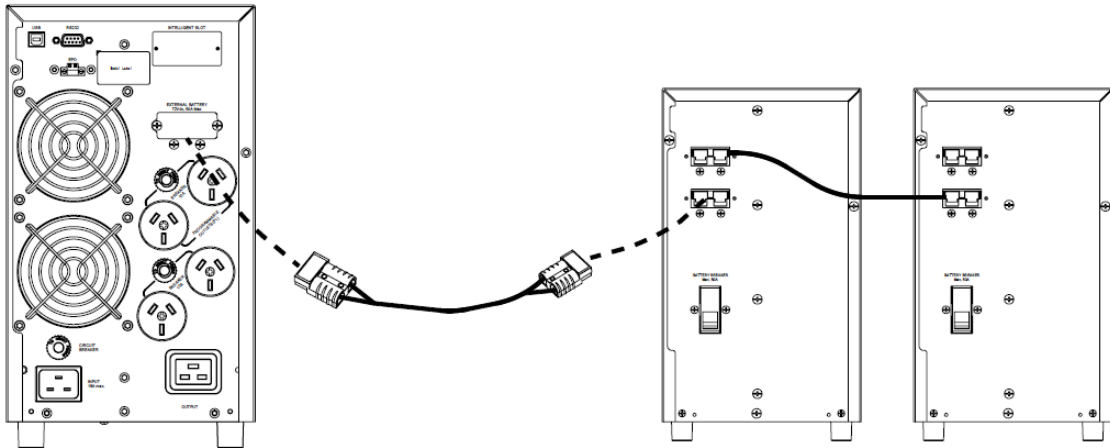

NB : Battery banks can be used with both types of UPS's. Although standard battery banks can be used with Long run UPS's usually these would have a customised larger battery bank. Standard battery banks are used more commonly with standard UPS's to increase backup times

For installation of PSCEBB18CH. Please refer detail installation manual included in the package of its product.

Step 4: Communication connection

Communication port:

USB port



RS-232 port

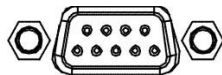

Intelligent slot



To allow for unattended UPS shutdown/start-up and status monitoring, connect the communication cable one end to the USB/RS-232 port and the other to the communication port of your PC. With the monitoring software installed, you can schedule UPS shutdown/start-up and monitor UPS status through PC.

The UPS is equipped with intelligent slot perfect for SNMP or AS400 card. When installing SNMP or AS400 card in the UPS, it will provide advanced communication and monitoring options.

Note : *USB port and RS-232 port cannot work at the same time.*

Note : *AS400 and SMNP card cannot work at the same time.*

Step 5: Disable and enable EPO (Emergency Power Off) function

Keep the pin 1 and pin 2 closed for UPS normal operation. To activate EPO(Emergency Power Off) function, cut the wire between pin 1 and pin 2.

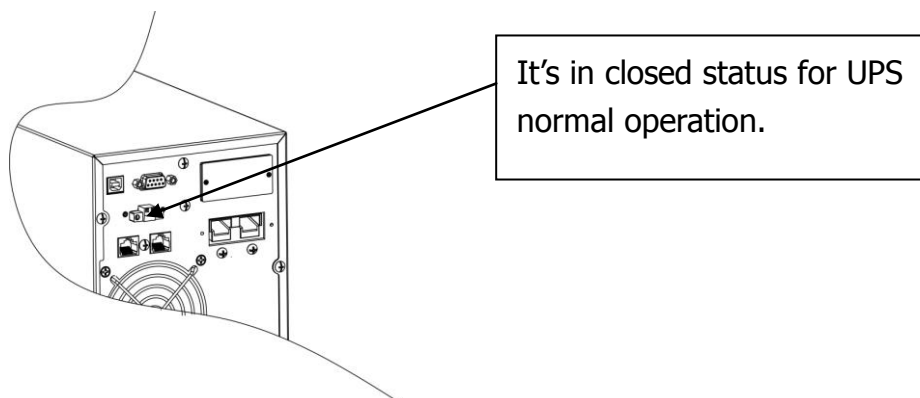

Step 6: Turn on the UPS

Press the ON/Mute button on the front panel for two seconds to power on the UPS.

Note: The battery charges fully during the first five hours of normal operation. Do not expect full battery run capability during this initial charge period.

Unit will perform "Self test " for 15 seconds and go to On line mode.

Note : Cold Start operation. When the UPS is off and there is no mains power, use cold start feature to apply power to the connected equipment from the UPS's battery. Cold start is not a normal condition.

To cold start the unit, push and hold the ON/mute button until you will hear a long beep. During the long beep, release the button and the unit will cold start.

Note : Unit is on battery mode therefore, the run time is limited.

Step 7: Install software

For optimal computer system protection, install NetGuard monitoring software to fully configure UPS shutdown that is included in the package.

In order to install the software, insert provided NetGuard CD into CD-ROM to install the monitoring software.

Please follow steps below to download and install monitoring software from the internet:

1. Go to the website <http://www.powershield.com.au>
2. Click PowerShield NetGuard software icon and then choose your required OS to download the software.
3. Follow the on-screen instructions to install the software.
4. When your computer restarts, the monitoring software will appear as an orange plug icon located in the system tray, near the clock.

3. Operations







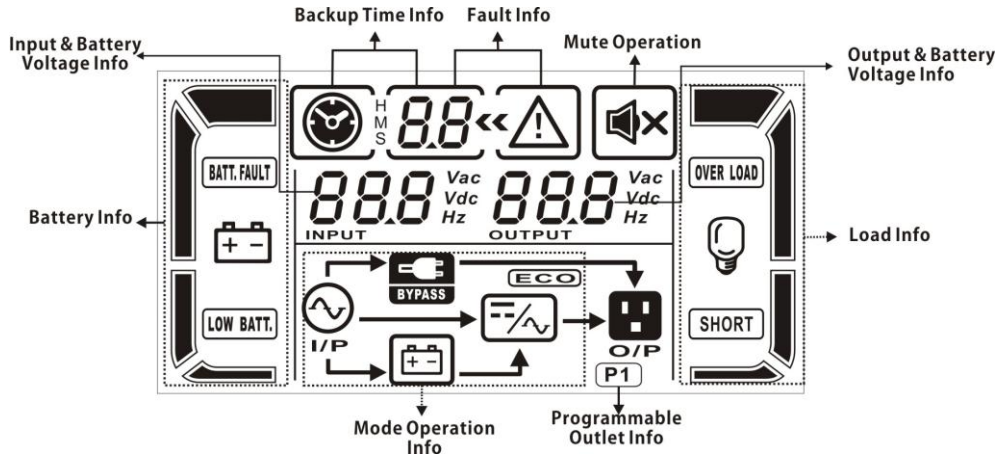

3-1. Button operation

Button	Function
ON/Mute Button	<ul style="list-style-type: none">➤ Turn on the UPS: Press and hold ON/Mute button for at least 2 seconds to turn on the UPS.➤ Mute the alarm: After the UPS is turned on in battery mode, press and hold this button for at least 5 seconds to disable or enable the alarm system. But it's not applied to the situations when warnings or errors occur.➤ Up key: Press this button to display previous selection in UPS setting mode.➤ Switch to UPS self-test mode: Press ON/Mute buttons for 5 seconds to enter UPS self-testing while in AC mode, ECO mode, or converter mode.
OFF/Enter Button	<ul style="list-style-type: none">➤ Turn off the UPS: Press and hold this button at least 2 seconds to turn off the UPS in battery mode. UPS will be in standby mode under power normal or transfer to Bypass mode if the Bypass enable setting by pressing this button.➤ Confirm selection key: Press this button to confirm selection in UPS setting mode.
Select Button	<ul style="list-style-type: none">➤ Switch LCD message: Press this button to change the LCD message for input voltage, input frequency, battery voltage, output voltage and output frequency. It will return back to default display when pausing for 10 seconds.➤ Setting mode: Press and hold this button for 5 seconds to enter UPS setting mode when UPS is off.➤ Down key: Press this button to display next selection in UPS setting mode.
ON/Mute + Select Button	<ul style="list-style-type: none">➤ Switch to bypass mode: When the main power is normal, press ON/Mute and Select buttons simultaneously for 5 seconds. Then UPS will enter to bypass mode. This action will be ineffective when the input voltage is out of acceptable range.

3-2. LCD Panel

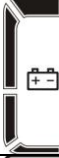

Display	Function
Backup time information	
	Indicates the backup time in pie chart.
	Indicates the backup time in numbers. H: hours, M: minute, S: second
Fault information	
	Indicates that the warning and fault occurs.
	Indicates the warning and fault codes, and the codes are listed in details in 3-5 section.
Mute operation	
	Indicates that the UPS alarm is disabled.
Output & Battery voltage information	
	Indicates the output voltage, frequency or battery voltage. Vac: output voltage, Vdc: battery voltage, Hz: frequency
Load information	
	Indicates the load level by 0-25%, 26-50%, 51-75%, and 76-100%.
	Indicates overload.
	Indicates the load or the UPS output is short circuit.
Programmable outlets information	
	Indicates that programmable management outlets are working.
Mode operation information	
	Indicates the UPS connects to the mains.
	Indicates the battery is working.

	Indicates the bypass circuit is working.
	Indicates the ECO mode is enabled.
	Indicates the Inverter circuit is working.
	Indicates the output is working.
Battery information	
	Indicates the Battery level by 0-25%, 26-50%, 51-75%, and 76-100%.
	Indicates the battery is fault.
	Indicates low battery level and low battery voltage.
Input & Battery voltage information	
	Indicates the input voltage or frequency or battery voltage. Vac: Input voltage, Vdc: battery voltage, Hz: input frequency

3-3. Audible Alarm

Battery Mode	Beep every 4 seconds
Low Battery	Beep every second
Overload	Beep twice every second
Fault	Continuously Beeping
Bypass Mode	Beep every 10 seconds

3-4. LCD display wordings index

Abbreviation	Display content	Meaning
ENA	<i>ENR</i>	Enable
DIS	<i>dI S</i>	Disable
ESC	<i>ESC</i>	Escape
HLS	<i>HLS</i>	High loss
LLS	<i>LLS</i>	Low loss
BAT	<i>bAt</i>	Battery
CF	<i>CF</i>	Converter
EP	<i>EP</i>	EPO
FA	<i>FR</i>	Fan
TP	<i>tP</i>	Temperature
CH	<i>CH</i>	Charger

3-5. UPS Setting

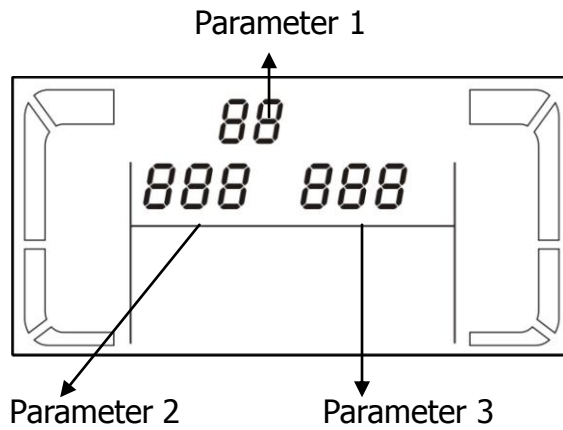

There are three parameters to set up the UPS.

Parameter 1: It's for program alternatives. There are 9 programs to set up. Refer to below table.

Parameter 2 and parameter 3 are the setting options or values for each program.

● **01: Output voltage setting**

Interface	Setting
	<p>Parameter 3: Output voltage For 208/220/230/240 VAC models, you may choose the following output voltage: 208: presents output voltage is 208Vac 220: presents output voltage is 220Vac 230: presents output voltage is 230Vac 240: presents output voltage is 240Vac</p>

● **02: Frequency Converter enable/disable**

Interface	Setting
	<p>Parameter 2 & 3: Enable or disable converter mode. You may choose the following two options: CF ENA: converter mode enable CF DIS: converter mode disable</p>

● **03: Output frequency setting**

Interface	Setting
	<p>Parameter 2 & 3: Output frequency setting. You may set the initial frequency on battery mode: BAT 50: presents output frequency is 50Hz BAT 60: presents output frequency is 60Hz If converter mode is enabled, you may choose the following output frequency: CF 50: presents output frequency is 50Hz CF 60: presents output frequency is 60Hz</p>

● **04: ECO enable/disable**

Interface	Setting
	<p>Parameter 3: Enable or disable ECO function. You may choose the following two options: ENA: ECO mode enable DIS: ECO mode disable</p>

● **05: ECO voltage range setting**

Interface	Setting
	<p>Parameter 2 & 3: Set the acceptable high voltage point and low voltage point for ECO mode by pressing Down key or Up key.</p> <p>HLS: High loss voltage in ECO mode in parameter 2. For 208/220/230/240 VAC models, the setting range in parameter 3 is from +7V to +24V of the nominal voltage.</p> <p>LLS: Low loss voltage in ECO mode in parameter 2. For 208/220/230/240 VAC models, the setting range in parameter 3 is from -7V to -24V of the nominal voltage.</p>

●

● **06: Bypass enable/disable when UPS is off**

Interface	Setting
	<p>Parameter 3: Enable or disable Bypass function. You may choose the following two options:</p> <p>ENA: Bypass enable</p> <p>DIS: Bypass disable</p>

● **07: Bypass voltage range setting**

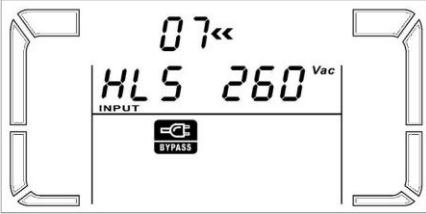
Interface	Setting
	<p>Parameter 2 & 3: Set the acceptable high voltage point and acceptable low voltage point for Bypass mode by pressing the Down key or Up key.</p> <p>HLS: Bypass high voltage point For 208/220/230/240 VAC models: 230-264: setting the high voltage point in parameter 3 from 230Vac to 264Vac.</p> <p>LLS: Bypass low voltage point For 208/220/230/240 VAC models: 170-220: setting the low voltage point in parameter 3 from 170Vac to 220Vac</p>

● **08: Programmable outlets enable/disable**

Interface	Setting
	<p>Parameter 3: Enable or disable programmable outlets.</p> <p>ENA: Programmable outlets enable</p> <p>DIS: Programmable outlets disable</p>

● **09: Programmable outlets setting**

Interface	Setting
	<p>Parameter 3: Set up backup time limits for programmable outlets.</p> <p>0-999: setting the backup time limits in minutes from 0-999 for programmable outlets which connect to non-critical devices on battery mode.</p>

● **10: Autonomy limitation setting**

Interface	Setting
	<p>Parameter 3: Set up backup time on battery mode for general outlets.</p> <p>0-999: setting the backup time in minutes from 0-999 for general outlets on battery mode.</p> <p>0: When setting as "0", the backup time will be only 10 seconds.</p> <p>999: When setting as "999", the backup time setting will be disabled. (Default)</p>

● **00: Exit setting**

















3-6. Operating Mode Description

Operating mode	Description	LCD display
Online mode	When the input voltage is within acceptable range, UPS will provide pure and stable AC power to output. The UPS will also charge the battery at online mode.	
ECO mode	Energy saving mode: When the input voltage is within voltage regulation range, UPS will bypass voltage to output for energy saving.	
Frequency Converter mode	When input frequency is within 40 Hz to 70 Hz, the UPS can be set at a constant output frequency, 50 Hz or 60 Hz. The UPS will still charge battery under this mode.	
Battery mode	When the input voltage is beyond the acceptable range or power failure and alarm is sounding every 4 second, UPS will backup power from battery.	
Bypass mode	When input voltage is within acceptable range but UPS is overload, UPS will enter bypass mode or bypass mode can be set by front panel. Alarm is sounding every 10 second.	
Standby mode	UPS is powered off and no output supply power, but still can charge batteries.	

3-7. Faults Reference Code











Fault event	Fault code	Icon	Fault event	Fault code	Icon
Bus start fail	01	x	Inverter voltage Low	13	X
Bus over	02	x	Inverter output short	14	SHORT
Bus under	03	x	Battery voltage too high	27	BATT. FAULT
Bus unbalance	04	x	Battery voltage too low	28	BATT. FAULT
Inverter soft start fail	11	x	Over temperature	41	X
Inverter voltage high	12	x	Over load	43	OVER LOAD

3-8. Warning indicator

Warning	Icon (flashing)	Alarm
Low Battery	 	Sounding every second
Overload	 	Sounding twice every second
Battery is not connected	 	Sounding every second
Over Charge	 	Sounding every second
Site wiring fault	 	Sounding every second
EPO enable	<i>EP</i> 	Sounding every second
Fan Failure	<i>FR</i> 	Sounding every second
Over temperature	<i>TP</i> 	Sounding every second
Charger failure	<i>CH</i> 	Sounding every second
Out of bypass voltage range	 	Sounding every second

4. Troubleshooting

If the UPS system does not operate correctly, please solve the problem by using the table below.

Symptom	Possible cause	Remedy
No indication and alarm even though the mains is normal.	The AC input power is not connected well.	Check if input power cord firmly connected to the mains.
	The AC input is connected to the UPS output.	Plug AC input power cord to AC input correctly.
The icon  and the warning code <i>EP</i> flashing on LCD display and alarm is sounding every second.	EPO function is activated.	Set the circuit in closed position to disable EPO function.
The icon  and  flashing on LCD display and alarm is sounding every second.	Line and neutral conductors of UPS input are reversed.	Rotate mains power socket by 180° and then connect to UPS system.
The icon  and  flashing on LCD display and alarm is sounding every second.	The external or internal battery is incorrectly connected.	Check if all batteries are connected well.
Fault code is shown as 27 and the icon  is lighting on LCD display and alarm is continuously sounding.	Battery voltage is too high or the charger is fault.	Contact PowerShield.
Fault code is shown as 28 and the icon  is lighting on LCD display and alarm is continuously sounding.	Battery voltage is too low or the charger is fault.	Contact PowerShield.
The icon  and  is flashing on LCD display and alarm is sounding twice every second.	UPS is overload	Remove excess loads from UPS output.
	UPS is overloaded. Devices connected to the UPS are fed directly by the electrical network via the Bypass.	Remove excess loads from UPS output.
	After repetitive overloads, the UPS is locked in the Bypass mode. Connected devices are fed directly by the mains.	Remove excess loads from UPS output first. Then shut down the UPS and restart it.
Fault code is shown as 43 and The icon  is lighting on LCD display and alarm is continuously sounding.	The UPS shut down automatically because of overload at the UPS output.	Remove excess loads from UPS output and restart it.
Fault code is shown as 14 and the icon  is lighting on LCD	The UPS shut down automatically because	Check output wiring and if connected devices are in

display and alarm is continuously sounding.	short circuit occurs on the UPS output.	short circuit status.
Fault code is shown as 1, 2, 3, 4, 11, 12, 13 and 41 on LCD display and alarm is continuously sounding.	A UPS internal fault has occurred. There are two possible results: 1. The load is still supplied, but directly from AC power via bypass. 2. The load is no longer supplied by power.	Contact PowerShield
Battery backup time is shorter than nominal value	Batteries are not fully charged	Charge the batteries for at least 5 hours and then check capacity. If the problem still persists, consult your dealer.
	Batteries defect	Contact your dealer to replace the battery.
The icon  and the warning code <i>FR</i> flashing on LCD display and alarm is sounding every second.	Fan is locked or not working	Check fans and notify dealer!!

5. Service

WARRANTY CONDITION:

The standard warranty is TWO (2) years from the date of purchase. The standard PowerShield procedure is to replace the original unit with a factory refurbished unit. PowerShield will ship the replacement unit once the defective unit has been received by the service department, or cross ship upon the receipt of a valid credit card number. The customer pays for shipping the defective unit to PowerShield. PowerShield pays ground freight transportation costs to ship the replacement to the customer within Australian capital cities metro areas only.

WARRANTY SERVICE PROCESS :

1. Review the problems discussed in the troubleshoot section of this manual to eliminate common problems.
2. Verify that no input/output circuit breaker are tripped. A tripped circuit breaker is the most common problem.
3. If the problem still persists, please call 1300-305-393 for technical support or fill in the form in PowerShield web page for on line technical support.
Following details are needed for warranty claims.
 - Model number
 - Serial number
 - The date of purchase
4. Be prepare to troubleshoot the problem over the phone with PowerShield technical support.
5. If technical support found that the product is defective, then the technical support will issue a Return Material Authorization Number (RMA #)
6. If the unit is under warranty, repair is free. If not there is a repair charge.
7. Pack the unit in its original packaging. Pack properly to avoid damage during transit.
Damage sustained in transit is not covered under warranty.
8. Mark the RMA # on the outside of the package.
9. Return the defective unit by insured, prepaid carrier to the address given to you by Technical support.

6. Storage and Maintenance

6-1. Operation

Centurion series contains no user-serviceable parts. If the battery service life (3~5 years at 25°C ambient temperature) has been exceeded, the batteries must be replaced.

Please contact your dealer or visit PowerShield web site.

www.powershield.com.au/support.php



Be sure to deliver the spent battery to a recycling facility or ship it to your dealer in the replacement battery packing material.

6-2. Storage

Before storing, charge the UPS 5 hours. Store the UPS covered and upright in a cool, dry location. During storage, recharge the battery in accordance with the following table:

Storage Temperature	Recharge Frequency	Charging Duration
-25°C - 40°C	Every 3 months	1-2 hours
40°C - 45°C	Every 2 months	1-2 hours

7. Contacting PowerShield

Refer to the information provided at PowerShield internet site:

www.powershield.com.au

Or

Phone 1300 305 393

8. Specifications

CAPACITY*		1000 VA / 800 W	1500 VA / 1200 W	2000 VA / 1600 W	3000 VA / 2400 W				
INPUT									
Voltage Range	Low Line Transfer	160VAC/140VAC/120VAC/110VAC±5% or 80VAC/70VAC/60VAC/50 VAC±5% (based on load percentage 100% - 80 % / 80 % - 70 % / 70 - 60 % / 60 % - 0)							
	Low Line Comeback	175 VAC ± 5 % or 85 VAC ± 5 %							
	High Line Transfer	300 VAC ± 5 % or 150 VAC ± 5 %							
	High Line Comeback	290 VAC ± 5 % or 145 VAC ± 5 %							
Frequency Range		40Hz ~ 70 Hz							
Phase		Single phase with ground							
Power Factor		≥ 0.99 @ 220-230 VAC (input voltage)							
OUTPUT									
Output voltage		Nominal 240Vac Programmable to 208/220/230Vac							
AC Voltage Regulation (Batt. Mode)		± 3%							
Frequency Range (Synchronized Range)		47 ~ 53 Hz or 57 ~ 63 Hz							
Frequency Range (Batt. Mode)		50 Hz ± 0.25 Hz or 60Hz ± 0.3 Hz							
Overload		100%~110%: audible warning 110%-130%: UPS shuts down in 30 seconds at battery mode or transfers to bypass mode when the utility is normal. >130%: UPS shuts down immediately at battery mode or transfer to bypass mode when the utility is normal.							
Current Crest Ratio		3:1							
Harmonic Distortion		≤ 3 % THD (Linear Load) ≤ 6 % THD (Non-linear Load)		≤ 4 % THD (Linear Load) ≤ 7 % THD (Non-linear Load)					
Transfer Time	AC Mode to Batt. Mode	Zero							
	Inverter to Bypass	4 ms (Typical)							
Waveform (Batt. Mode)		Pure Sinewave							
EFFICIENCY									
AC Mode		~ 85%		~ 88%					
Battery Mode		~ 83%							
BATTERY									
Standard Model	Battery Type	12 V / 9 AH	12 V / 9 AH	12 V / 9 AH	12 V / 9 AH				
	Numbers	3	3	6	6				
	Recharge Time	4 hours recover to 90% capacity (Typical)							
	Charging Current	1.0 A(max.)							
	Charging Voltage	41.0 VDC ± 1%		82.1 VDC ±1%					
Long-run Model	Battery Type & Numbers	Depending on the capacity of external batteries							
	Charging Current	8.0 A(max.)							
	Charging Voltage	41.0 VDC ± 1%		82.1 VDC ±1%					
PHYSICAL									
Tower Case	Dimension, D X W X H	397 X 145 X 220 (mm)			421 X 190 X 318 (mm)				
	Net Weight (kgs)	13	7	14	7	26	13	28	13
Rack Case	Dimension, D X W X H	420x438x88[2U] (mm)			580x438x133[3U] (mm)				
	Net Weight (kgs)	16	10	17	10	29	17	31	17
ENVIRONMENT									
Operation Humidity		20-90 % RH @ 0- 40°C (non-condensing)							
Noise Level		Less than 45dBA @ 1 Meter							
MANAGEMENT									
RS-232 or USB		Supports Windows® 2000/2003/XP/Vista/2008, Linux, Unix and MAC							
Optional SNMP		Power management from SNMP manager and web browser							

* Derate capacity to 60% of capacity in Frequency converter mode and to 80% when the output voltage is adjusted to 208VAC.

**Product specifications are subject to change without further notice.

