



Aeon Series

EDGE FREE® Fixed Frame Projection Screen

User's Guide

Applies to all available screen materials: CineGrey 3D EDGE FREE® and CineWhite EDGE FREE®







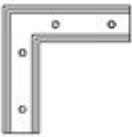

Product Description:

The **Aeon Series** is a fixed frame projection screen that uses Elite's EDGE FREE® technology. The EDGE FREE® design resembles a giant size flat panel TV display. The **Aeon** includes a velvet tape as an installation option to further enhance the frame appearance and absorb projector overshoot. An **optional LED edge backlighting kit** is available for added visual appearance. For more information on the LED kit please visit:

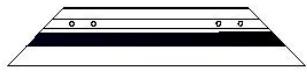
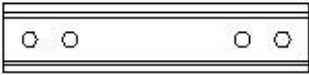
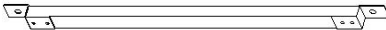
<http://www.elitescreens.com/index.php/products/accessories-others/2085-led-kit>

Hardware and Parts List

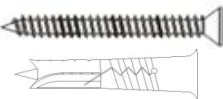
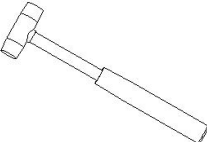
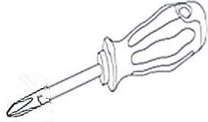
Please make sure all parts listed below are included before installation.

<p>A. Elbow joint x 4 pcs</p> 	<p>B. Top/Bottom horizontal frame x 4 pcs</p> 	<p>C. Left/Right vertical frame x 2 pcs</p> 
<p>D. Center joints x 2 pcs</p> 	<p>E. Center support bar x 1-2 pc</p> 	<p>F. Wall brackets x2-3 pcs</p> 
<p>G. M6 screw x 2-4 pcs</p> 	<p>H. M5x15 screw x 24 pcs</p> 	<p>I. M6x12 screw x 2-4pcs</p> 
<p>J. M5x50 screws and anchor x 6 pcs</p> 	<p>K. Rubber hammer x 1 pc</p> 	<p>L. Screwdriver x1 pc</p> 
<p>M. Velvet tape</p> 		

Frame Assembly

Note: Refer to the section “Splicer Installation” if joining two or more frames.

1. Insert the center joint into one of the 1/2 horizontal frames and fasten it with the two *M5x15 screws* (H).
2. Insert the other 1/2 horizontal frame piece to the center joint and fasten also using two *M5x15 screws*.
3. Repeat steps 1 and 2 for assembling the second horizontal frame.

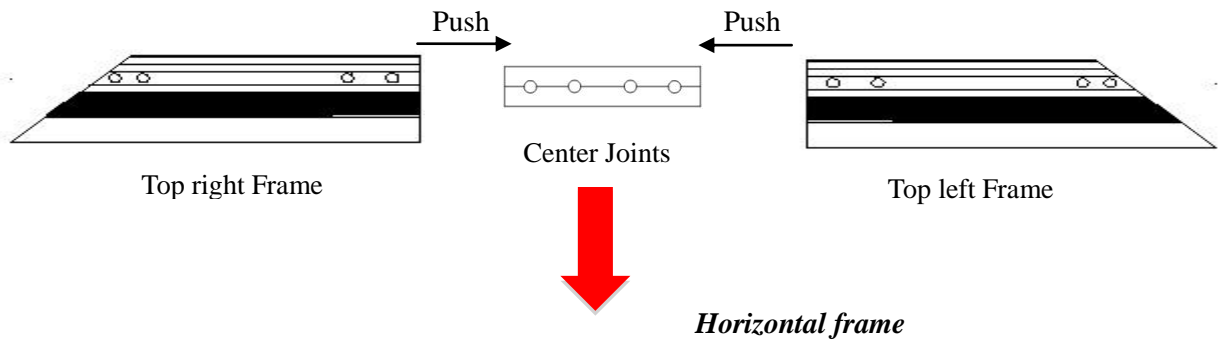

4. Insert and slide in one *M6 screws* (G) through the channel located on the back each *horizontal frame*.

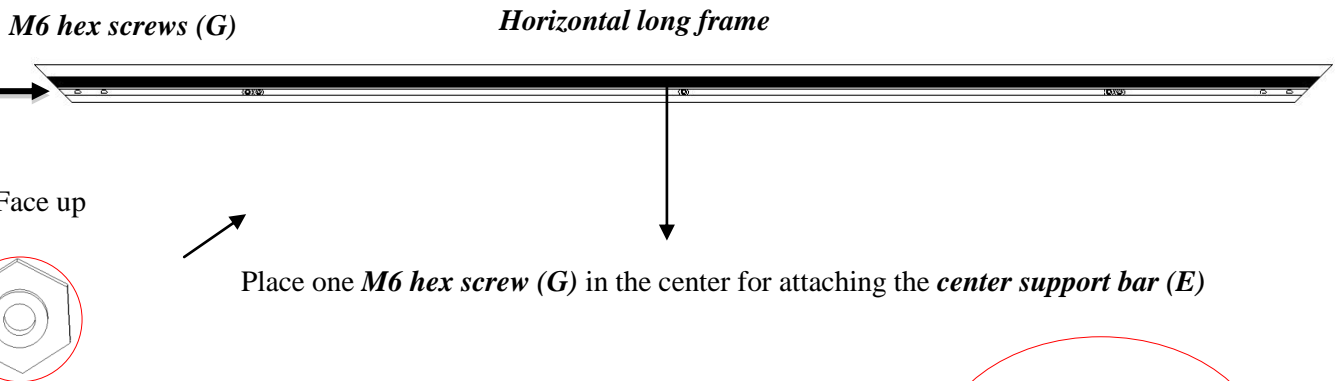

5. Insert the *elbow joint* (A) into each end of the *horizontal frames* (B) shown below.

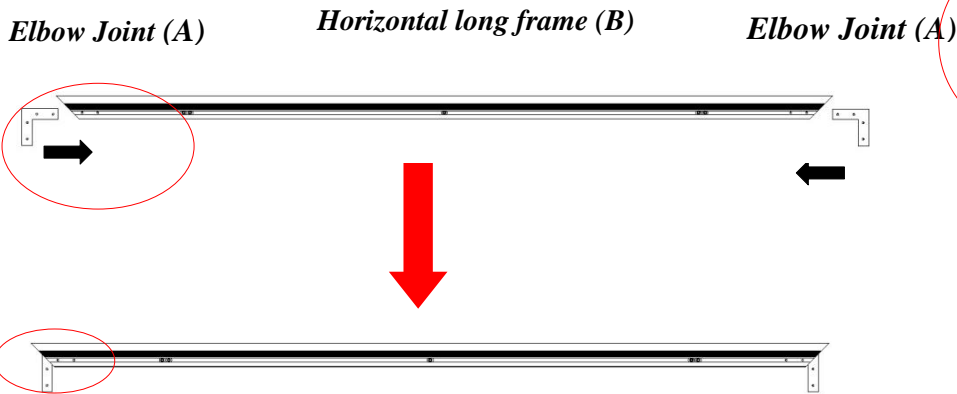
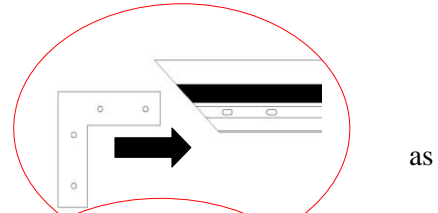

6. Insert the two *vertical short frames (C)* into the *elbow joint (A)*.

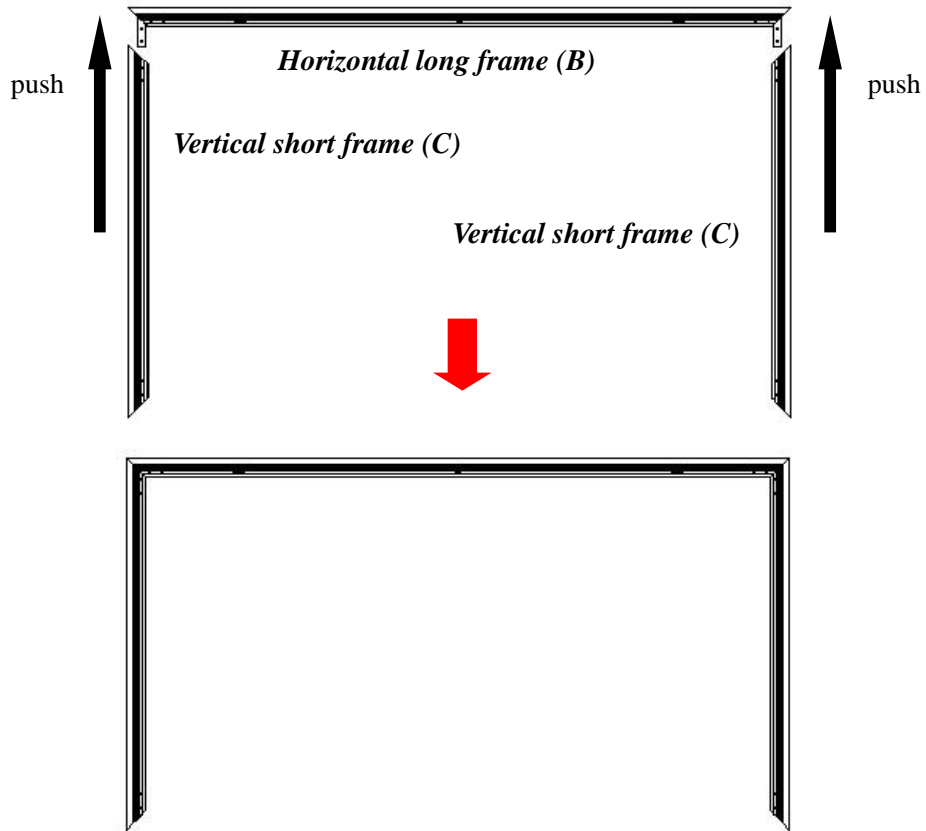

7. Join the remaining *horizontal long frame (B)* with the frame built in the previous steps as shown below.

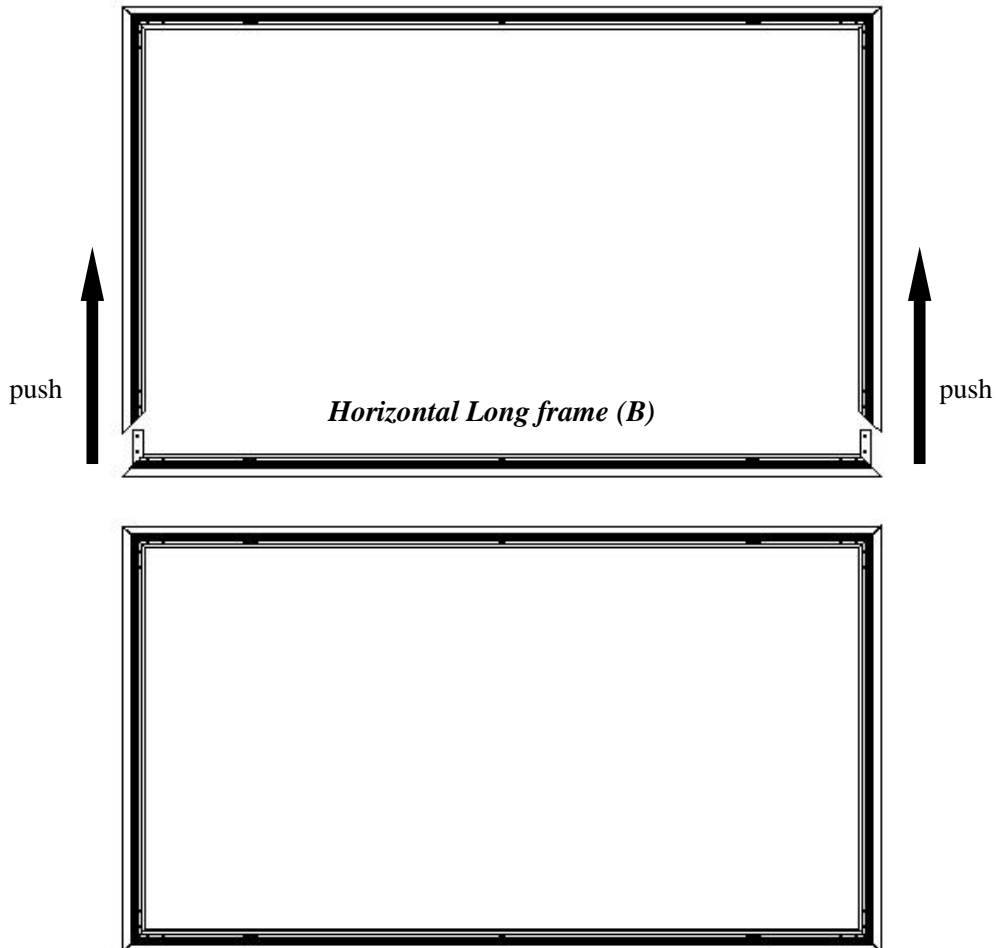

8. Make sure all four corners are properly in place to form a perfect rectangle. Then fasten the four angles with the **M5x15 Screws (H)**.

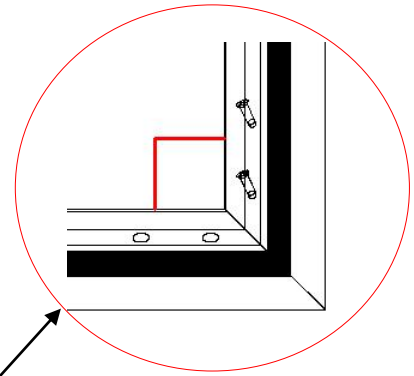
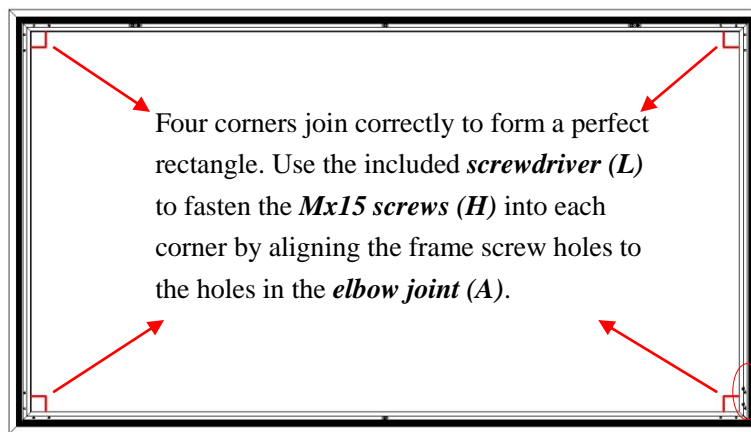

Screen Material Installation

1. Lay the **screen material** completely flat with the front facing down on a clean surface in a horizontal position. The back side of the screen material should be placed upwards.

Note: The back side of the material has the velcro borders all around the edges.

2. Carefully and gently place the assembled frame on top the screen material as shown below. Make sure to not allow the angle edge of the frame to come in direct contact with the screen material to avoid puncturing it.

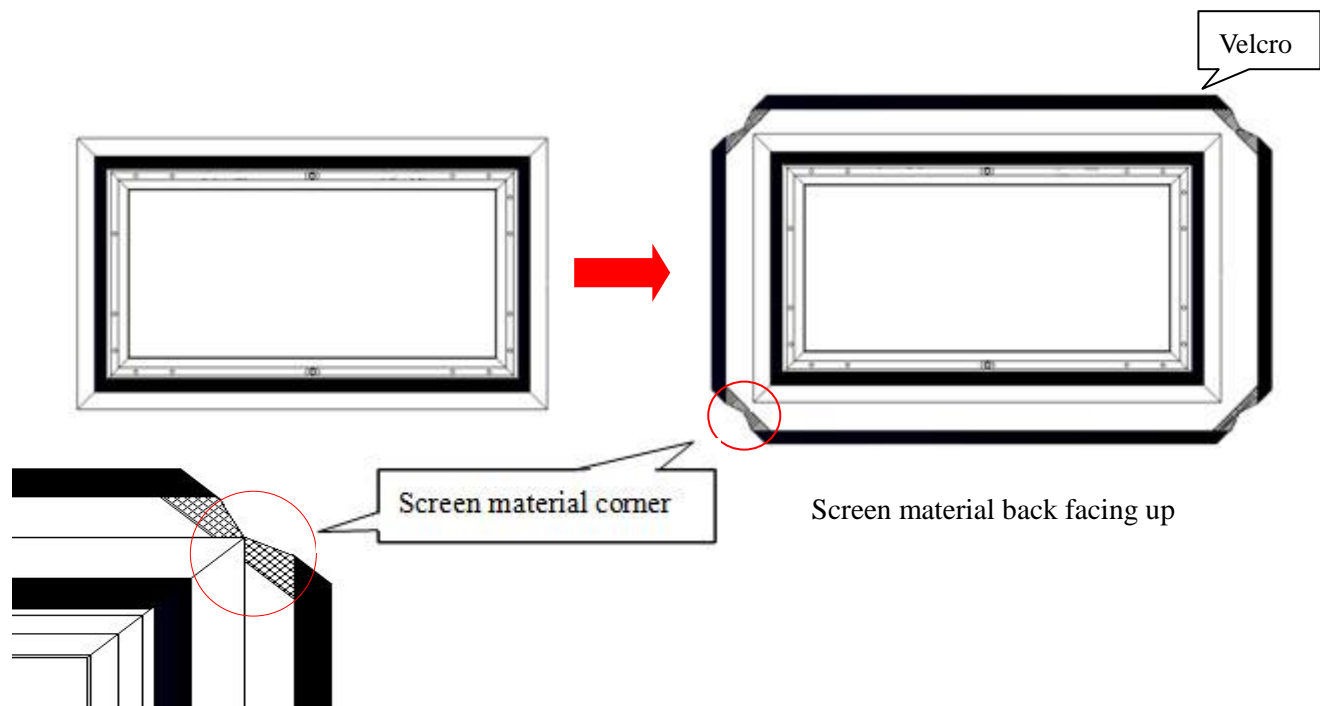

3. After all of the corners of the frame have been properly aligned, attach the material to the frame in the following order **A→B→C→D** (see instructions below for details).

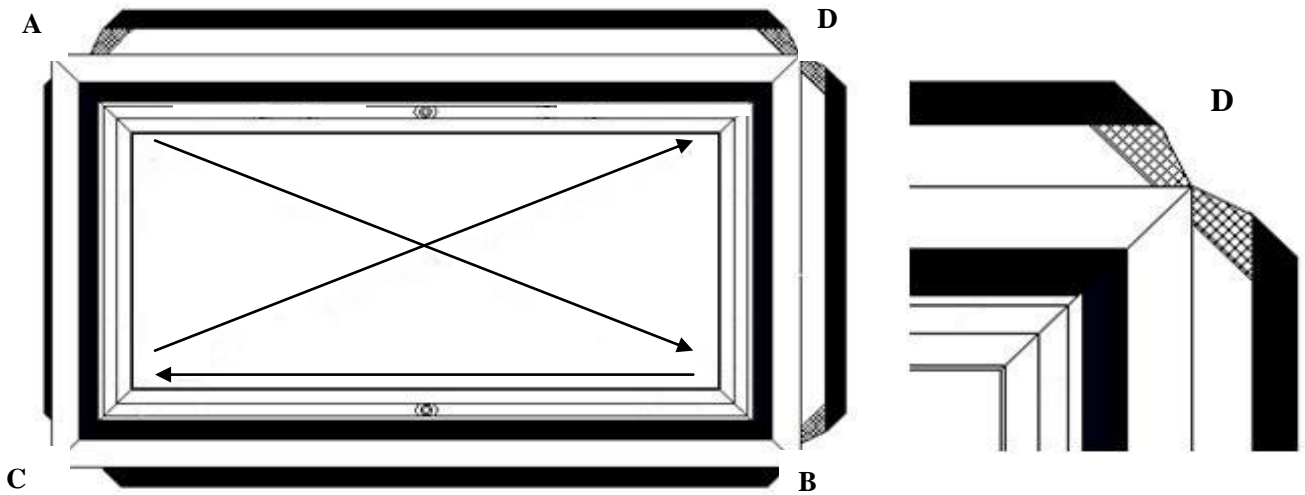

Attach the screen material to the corners as shown below.

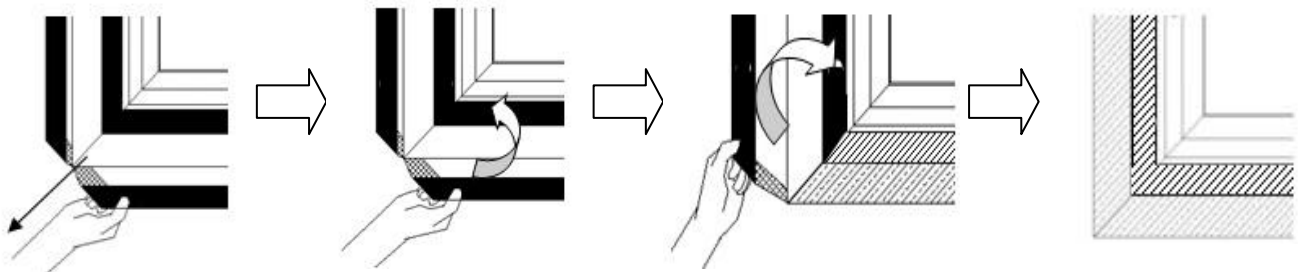

1) Stretch the screen material in the direction of the arrowhead.

2) Fold over and attach material to the velcro strip of the frame.

3) Fold over second side and attach to frame

4) Repeat until all four sides are done in the order A, B, C, D

4. After all four corners have been attached, please check whether the frame corners are wrapped by the screen material. If not, please loosen the velcro connection and repeat the above steps so the frame is not exposed.

Note:

Represents the screen material

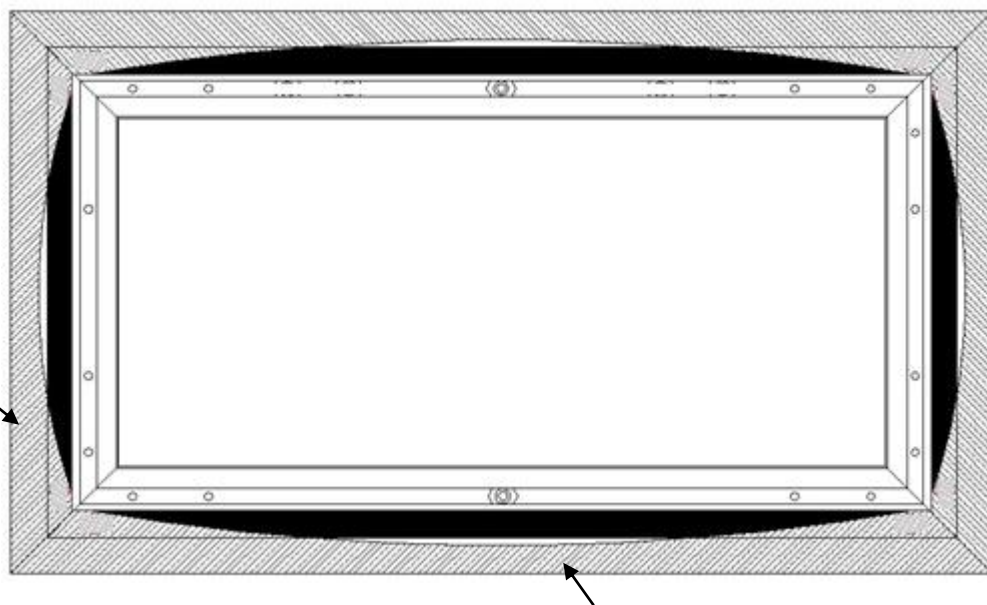
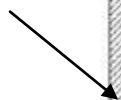

Note: The black shaded part represents the velcro on the frame. That Velcro end will ultimately attach with the other velcro end on the screen material.

5. Proceed to attach the rest of the material to the frame as described in the illustrations below.

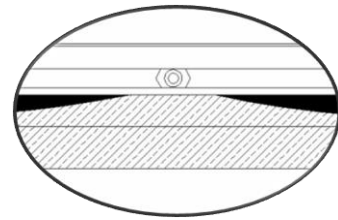
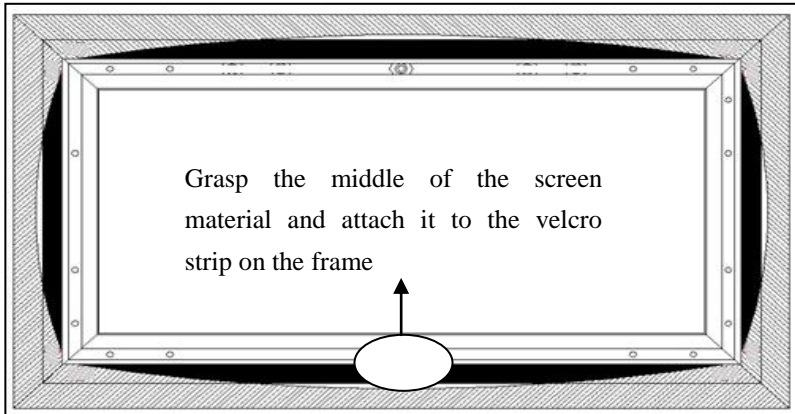

Lay the Velcro end on the screen material over the Velcro end of the frame and keep it within the edge.



Proceed in the following sequence below ①→②

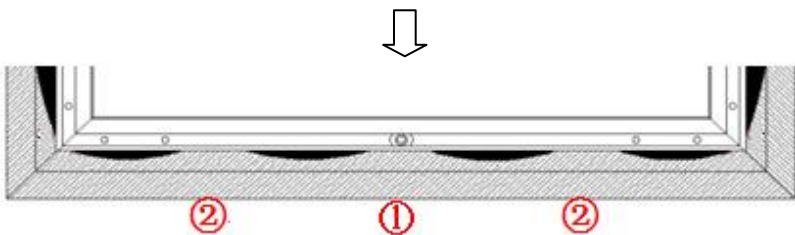

The key is to attach within the middle sections of 1 and 2. Then continue attaching the remaining unattached areas.

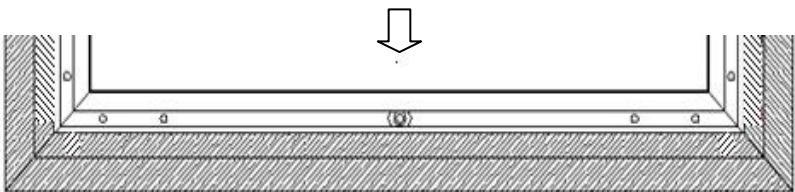

Repeat the same steps on remaining three sides in the sequence A, B, C, D as show below.

A

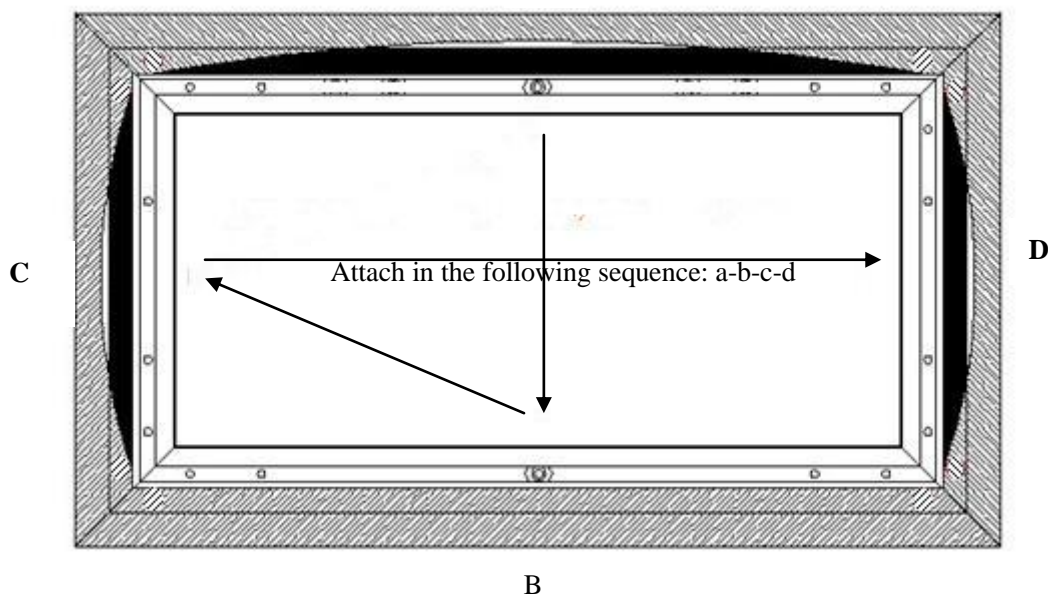

Screen Material Removal

Follow the steps to properly remove the screen material from the frame. This procedure will ensure prolonging the life of the screen material.

1. Detach the velcro from the frame.
2. Gently pull back the material to release the material from the velcro connections on the corners

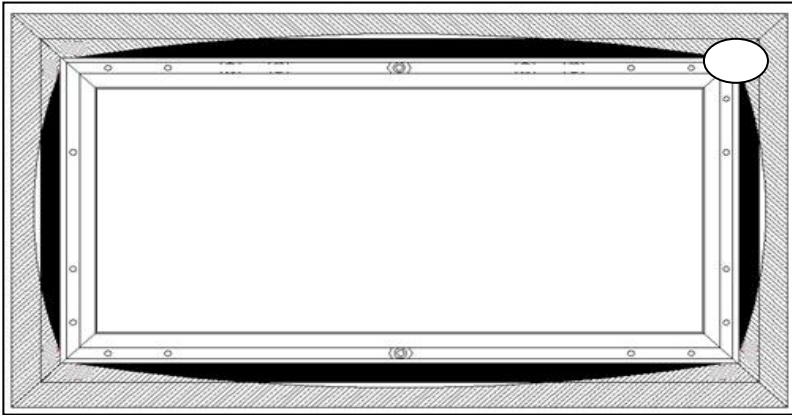

Pull back the screen material from the velcro connection along the edges of the frame to detach it.

Support bar installation

1. Position the *center support bar (E)* in the middle of the frame and align the hole on each end of the support bar with the *M6 hex screws (G)* on the top and bottom frames. Then fasten with the *M6x12 screws (I)*.

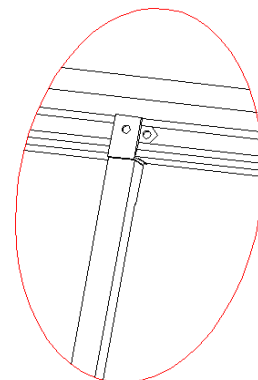
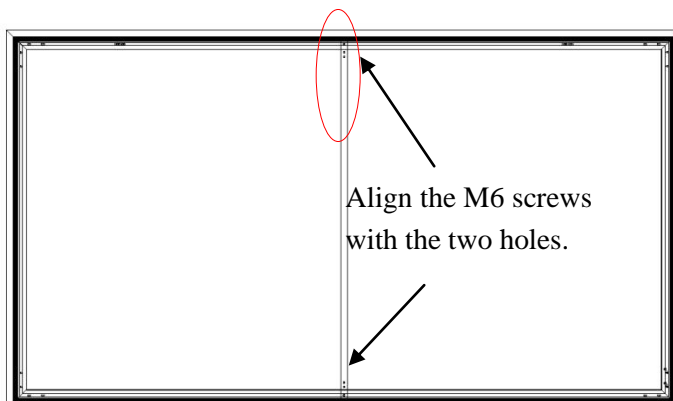
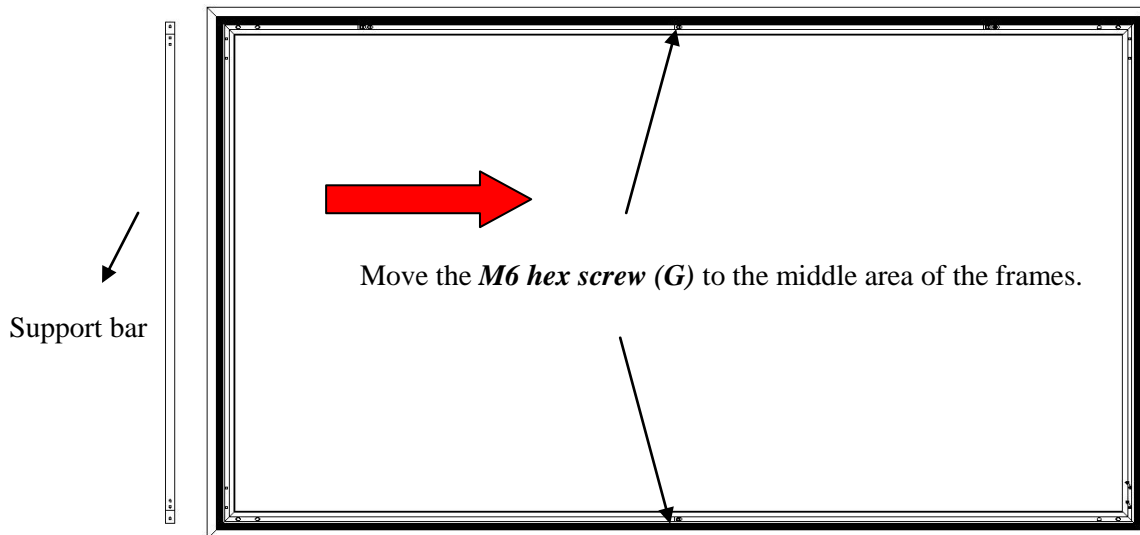

Notice to Installer:

These instructions only apply if you have the *CineGrey 3D ALR* material. Please use the following installation instructions to obtain superior optical performance from the Angular Reflective ALR (Ambient Light Rejecting) Screen.

Projector Ceiling Installation: Make sure the projector (*light in*) is angled ($\Theta 1$) to reflect ($\Theta 2$) at the mirror-opposite angle (*light out*) to align with the viewer's eye level.

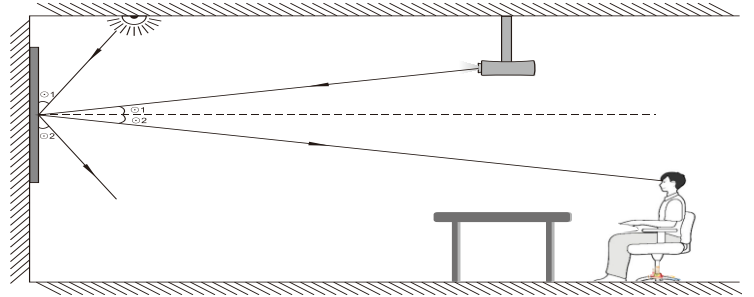

Projector Table Top: Make sure the projector (*light in*) is angled ($\Theta 1$) to reflect ($\Theta 2$) at the mirror-opposite angle (*light out*) to align with the viewer's eye level.

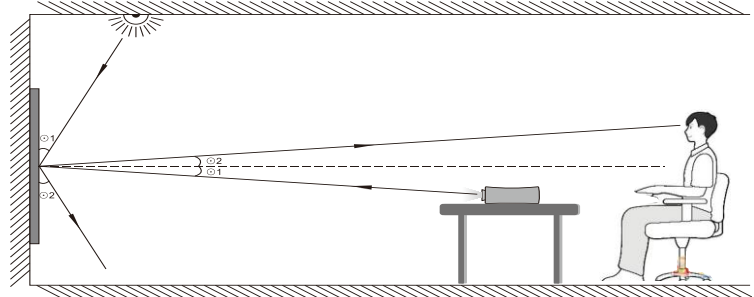

Images are not up to scale and are for illustrations purposes only.

Note: Improper installation will result in light loss and produce a dark image. This is due to the projector's light reflecting in the wrong direction.

Velvet Tape Trim Installation

Attention: Installing the velvet trim will reduce the viewing size of your screen. See below illustrations for a comparison of the viewing size of the before and after edge trim installation using the 100" & 120" 16:9 diagonal models.

100" comparison:

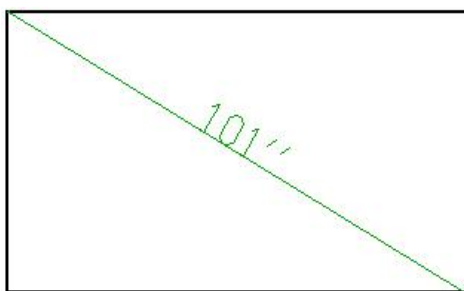

Before installing the trim strip

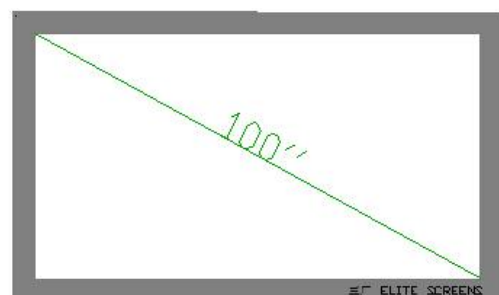

After installing the trim strip

120" comparison:

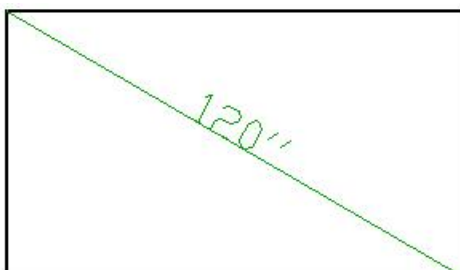

Before installing the trim strip

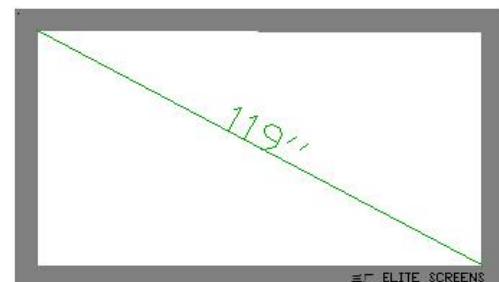

After installing the trim strip

- 1) Lay the assembled frame on its back on a clean surface.

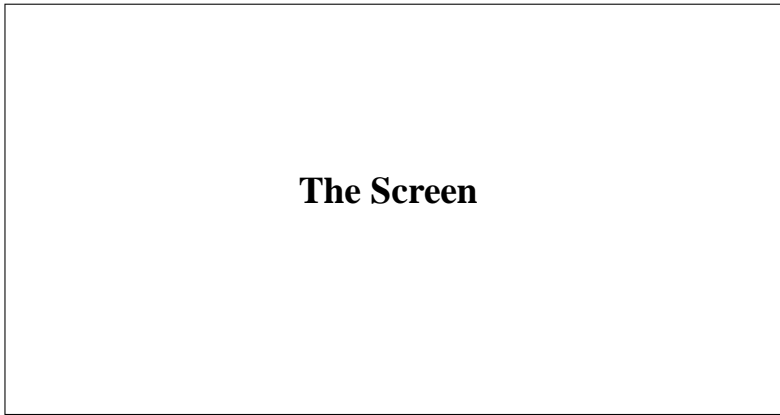

- 2) Measure 10 mm (0.40") from the edge of the frame to the inside of the material.

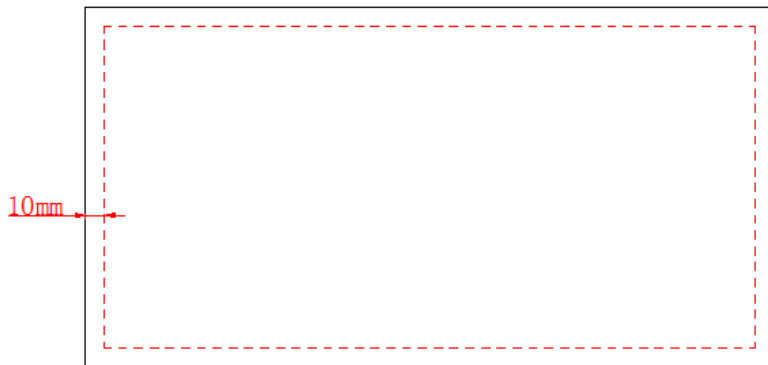
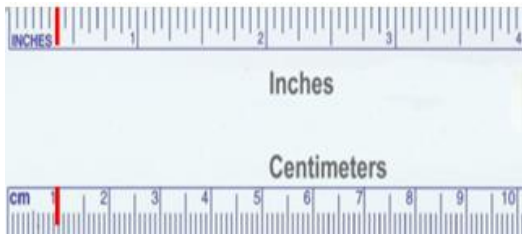

- 3) Make a light mark with a pencil approximately every 8-10 inches apart. This will help guide the way to making a straight line for the velveteen strip.

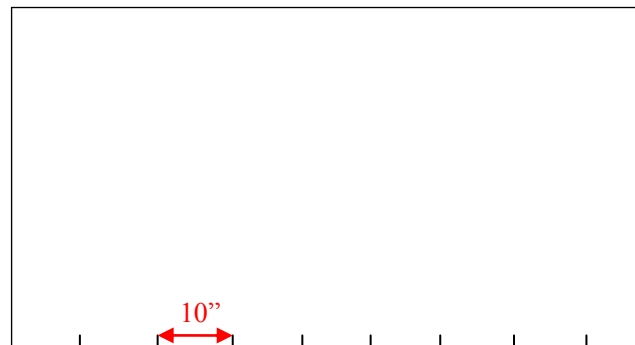

- 4) Repeat steps 2 and 3 on the remaining sides

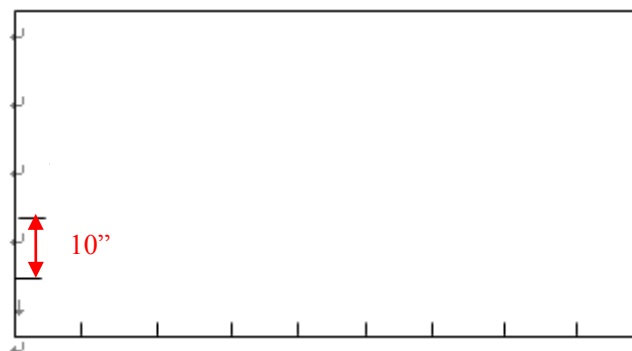

5) Peel off the backing on the velvet strip and align the top edge at the 10 mm mark.

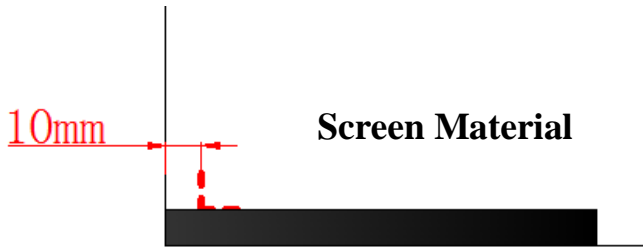

6) Continue peeling off the backing until the other side has been reached. Make sure that the velvet strip is kept straight the entire way.

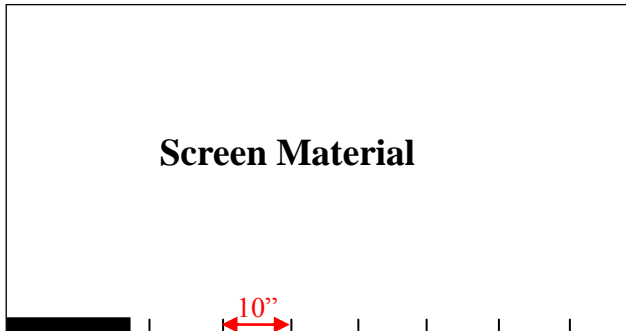

7) Fold back the excess unused velveteen.

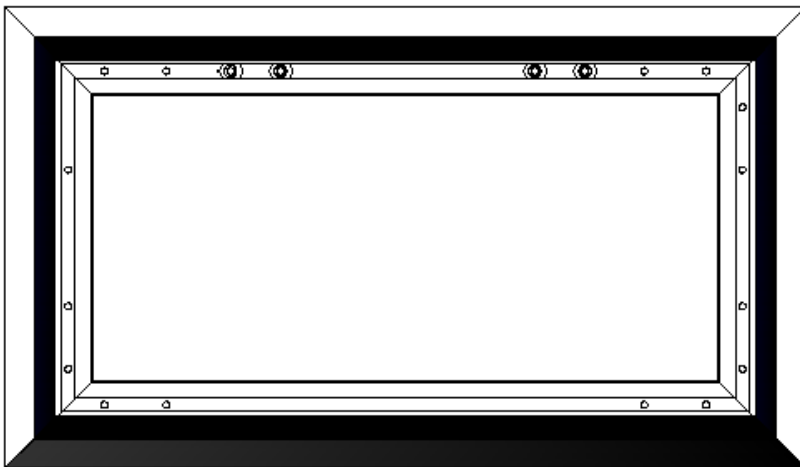

8) Repeat steps 5-7 to complete the velveteen strip installation.



Installation

Locate your desired installation location with a stud finder (recommended) and mark the drill-hole area of where the screen is to be installed.

1. Drill a hole with the proper bit size according to the wood screws included.
2. Line up the wall brackets with the drilled holes on the installation location and screw them in using a Phillips screwdriver.
3. Position the frame screen onto the **wall brackets (F)** as shown in **below**.
4. The design of the wall brackets allows the frame to slide over them through its sides. This is an important feature of the installation design as it allows your screen to be properly centered.

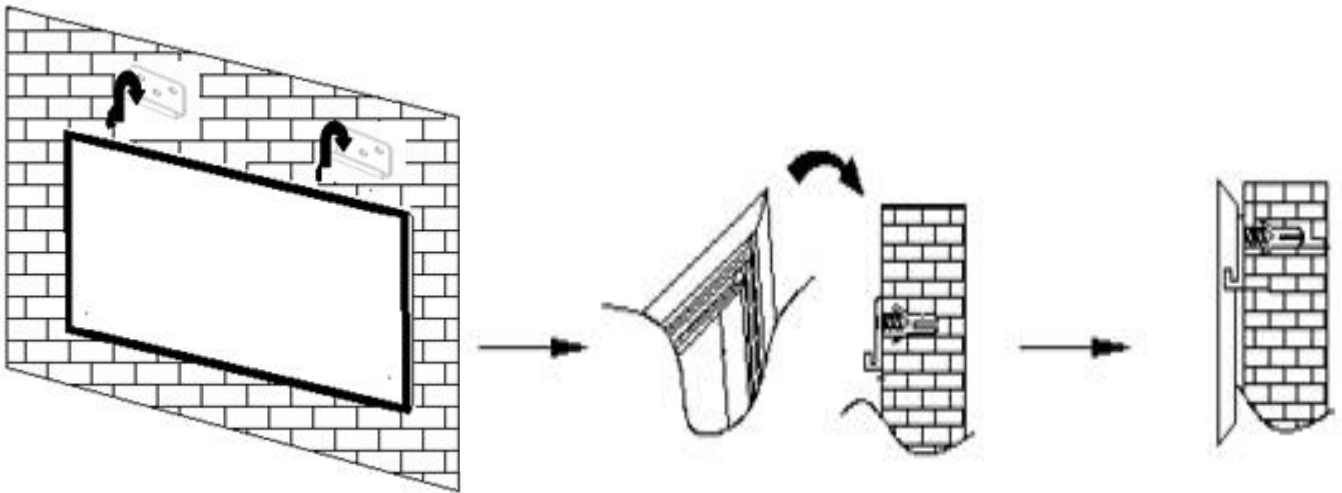

Splicer Installation (sold separately)

If you want to joint two frameworks, please insert twelve **M6 screws** into each vertical short frame each before completely assembling the frame. See figure below for example.

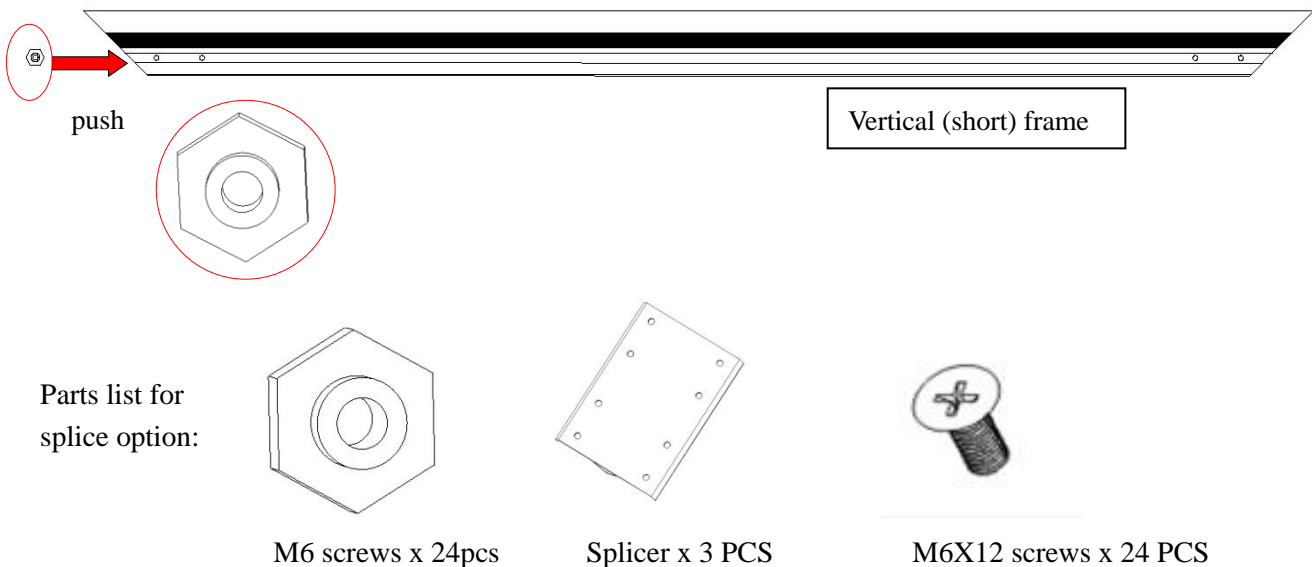

1. Layout the frame:

The two frameworks should be parallel and aligned as shown below.

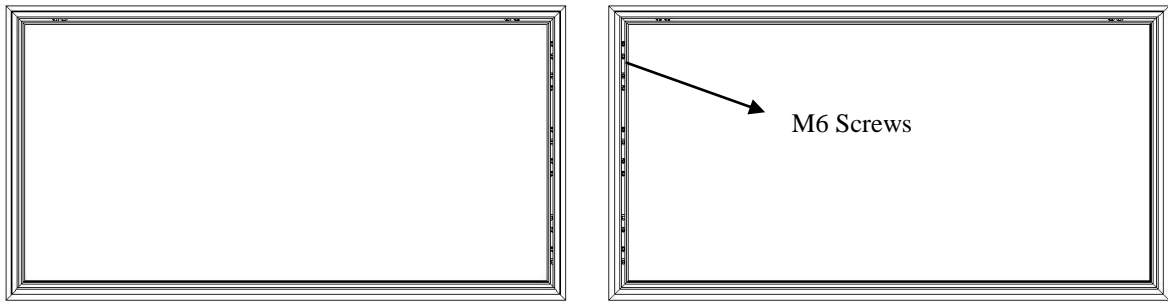

2. Align the position of the M6 screws with the splicer.

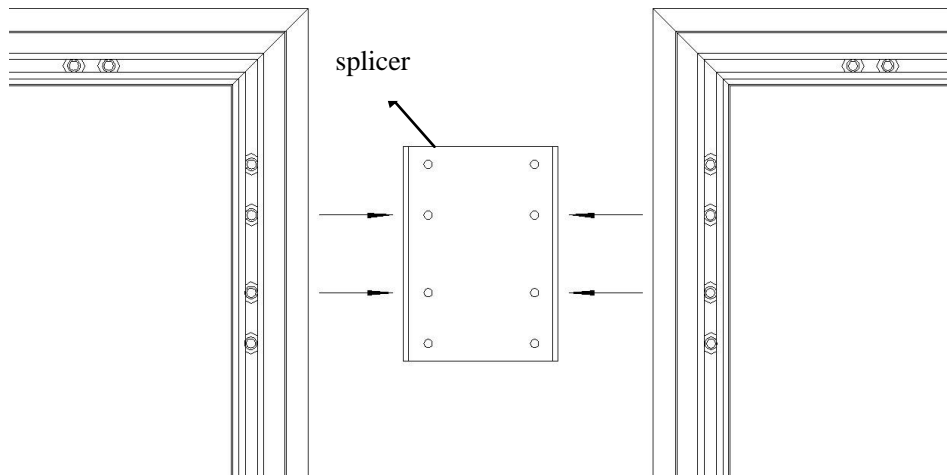

3. Join the frames together with the splicer, and tighten the frame and splicer with **M6X12 screws** as shown in the figure below:

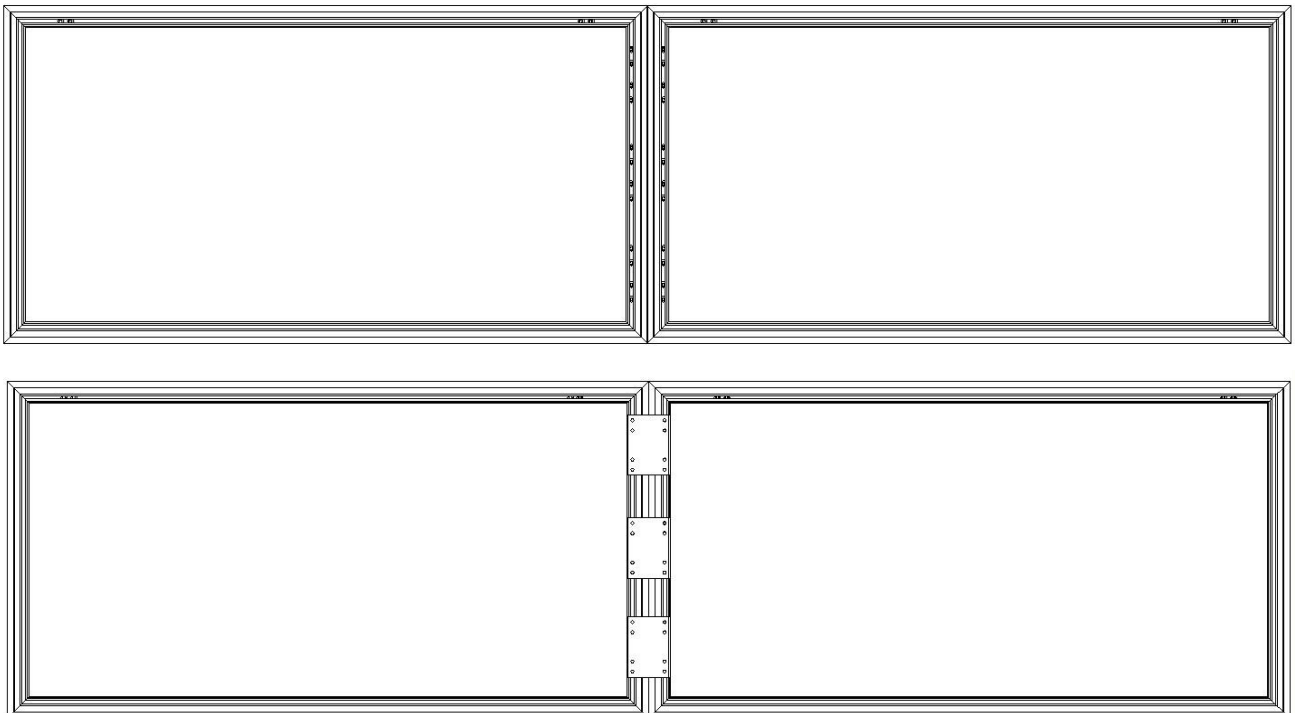

For a local Elite Screens contact or Technical Support, please visit

www.elitescreens.com