

## DataTraveler® 2000

Find the language and latest documentation for DT2000 here.

### DT2000 Installation Guide

-  ..... For instructions in English
-  ..... Para instrucciones en Español
-  ..... Für Anleitungen in Deutsch
-  ..... Pour des instructions en Français
-  ..... Per le istruzioni in Italiano
-  ..... Por as instruções em Português
-  ..... Instrukcje w języku Polskim
-  ..... Для инструкции на русском
-  ..... Türkçe talimatlar için
-  ..... Japanese
-  ..... Thai
-  ..... Vietnamese

Simplified Chinese ..... 中文说明

Traditional Chinese .... 中文說明

## DataTraveler® 2000 - User Manual



**Remember to save your PIN in a safe place. If you lose or forget your PIN, there is no way to access the data stored on the Kingston DataTraveler®.**

**If you are having difficulty, please refer to this complete user guide loaded on your DT2000, also available at Kingston's website: [kingston.com/support](http://kingston.com/support)**

DataTraveler® 2000 incorporates DataLock® Technology licensed from ClevX, LLC.

©2016 Kingston Technology Europe Co LLP and Kingston Digital Europe Co LLP, Kingston Court, Brooklands Close, Sunbury-on-Thames, Middlesex, TW16 7EP, England. Tel: +44 (0) 1932 738888 Fax: +44 (0) 1932 785469. All rights reserved. All trademarks and registered trademarks are the property of their respective owners.



## Table of Contents

System Requirements .....	3
Introduction.....	4
1. DT2000 layout .....	5
2. LED indicators and their actions.....	5
3. How to use the DT2000 for the first time.....	6
4. How to change the User PIN.....	6
5. How to enable Options .....	7
6. How to enable Read-Only Mode .....	8
7. How to enable Read/Write Mode .....	8
8. How to set the Timeout Lock Mode.....	9
9. How to disable the Timeout Lock Mode .....	9
10. How to determine the DT2000 version number.....	10
11. Brute force hacking detection.....	10
12. How to reset the DT2000 .....	11
13. How to configure the DT2000 with Windows OS .....	12
14. How to configure the DT2000 with Mac OS .....	15



---

## About This Guide

This user guide is for Kingston's DataTraveler® 2000 (referred to simply as DT2000 from this point forward).

## System Requirements

---

### PC Platform

### Supported PC Operating Systems

- Windows 10
  - Windows 8/8.1
  - Windows 7
  - Windows Vista® SP2
- 

### Mac Platform

### Supported Operating Systems

- Mac OS X 10.8.x - 10.11x
- 

### Linux Platform

### Supported Operating Systems

- Linux v2.6 kernel+
- 

### Other Platforms

### Supported Operating System

- Chrome OS™, Android\*
- 

\*Compatible devices only. Check with the manufacture of your device to see if it supports USB Flash drives.



## Introduction



**Note:** The DT2000 rechargeable battery is not fully charged out of the box. We recommend that you charge the battery prior to first use. To charge, plug the DT2000 in to a powered USB port for 60 minutes to fully charge the battery.

Thank you for purchasing the DataTraveler<sup>®</sup> 2000, an ultra-secure and easy-to-use hardware-encrypted USB 3.0 PIN-activated flash drive.



The DT2000 uses military-grade XTS-AES 256-bit hardware encryption, which encrypts all data stored on the drive in real time. The DT2000 requires no software and is OS and host independent.

The DT2000 incorporates a rechargeable battery that allows you to enter a 7-15 digit PIN (Personal Identification Number) using the on-board keypad before connecting the drive to a USB port.

Should the drive be lost or stolen, you can rest assured that all data held on the DT2000 is safe and cannot be accessed by any unauthorised person.

The DT2000 unlocks using the on-board keypad and is not unlocked by a host computer. It is not vulnerable to software/hardware-based key loggers or brute force attacks.









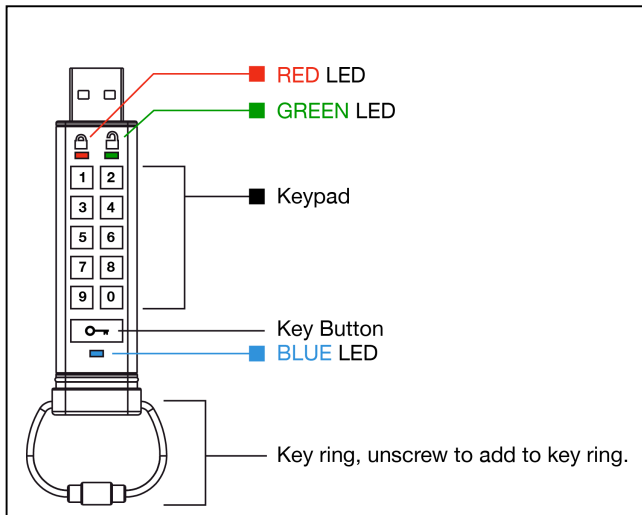









**Caution:** The DT2000 is shipped with a default PIN of User PIN of  1-1-2-2-3-3-4-4  and, although it can be used straight out of the box with the default PIN, for security reasons we **highly recommend that you create a new User PIN immediately** by following the instructions under section 4 'How to change User PIN'.

If you forget your PIN, all data will be inaccessible.

## 1. DT2000 layout







## 2. LED indicators and their actions

LED	LED State	Description	LED State	Description	Description
	<b>Red</b> Black fade out 	Locking down/incorrect PIN entry		<b>Red and Green</b> blinking alternately 	Factory reset
	<b>Red</b> blinking 	Locked and awaiting factory default PIN or defined PIN entry			
	<b>Green</b> solid 	DT2000 is unlocked		<b>Green and Blue</b> blinking together 	User option mode
	<b>Green</b> blinking 	When connected to a USB port, if <b>Green</b> LED blinks every 2 seconds this indicates the DT2000 has been set as 'Read Only'			
	<b>Blue</b> solid 	Connected to a USB port			
	<b>Blue</b> blinking 	Data exchange with host/changing User PIN			

### 3. How to use the DT2000 for the first time

The DT2000 is shipped with a default PIN of 11223344 and although it can be used straight out of the box with the default PIN, for security reasons we highly recommend that you create a new User PIN immediately by following the instructions under section 4 'How to change the User PIN'.

Follow the 3 simple steps in the table below to unlock the DT2000 with the default PIN.

Instructions (first time use)	LED	LED State
1. Press KEY button once 		<b>Red, Green &amp; Blue</b> LEDs will flash together once and then the <b>Red</b> LED will continue to blink
2. Within 10 seconds, enter the User PIN (default - 11223344) to unlock the DT2000		<b>Red</b> LED will continue to blink
3. Press KEY button once 		<b>Red</b> solid LED changes to <b>Green</b> solid LED indicating successful default User PIN entry



**Note:** Once the DT2000 has been successfully unlocked, the **Green** LED will remain on and in a solid state for 30 seconds only, during which time the DT2000 needs to be connected to a USB port. It can be locked down immediately by pressing and holding down the KEY button  for 3 seconds, or waiting for the 30 seconds to expire or by clicking the 'Safely Remove Hardware and Eject Media' icon within your operating system.

### 4. How to change the User PIN

PIN requirements:

- Must be between 7-15 digits in length
- Must not contain only repetitive numbers, e.g. (3-3-3-3-3-3)
- Must not contain only consecutive numbers, e.g. (1-2-3-4-5-6-7), (7-8-9-0-1-2-3-4), (7-6-5-4-3-2-1)















**Password tip:** You can create a memorable word, name, phrase or any other alphanumeric PIN combination simply by pressing the key with the corresponding letters on it.

Examples of these types of alphanumeric PINs are:

- For "**password**", you would press the following keys:  
7 (pqrs) 2 (abc) 7 (pqrs) 7 (pqrs) 9 (wxyz) 6 (mno) 7 (pqrs) 3 (def)
- For "**kingston**", you would press:  
5 (jkl) 4 (ghi) 6 (mno) 4 (ghi) 7 (pqrs) 8 (tuv) 6 (mno) 6 (mno)

This method enables you to create long PINs that are easy to remember.

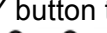
Instructions	LED	LED State
--------------	-----	-----------

1. Press KEY button once 		<b>Red, Green &amp; Blue</b> LEDs will flash together once and then the <b>Red</b> LED will continue to blink
2. Within 10 seconds, start to enter the User PIN (default - 11223344) to unlock the DT2000		<b>Red</b> LED will continue to blink
3. Press KEY button once 		<b>Red</b> solid LED changes to <b>Green</b> solid LED indicating successful default User PIN entry
4. Press the KEY button twice (double-click)  		<b>Blue</b> LED blinks
5. Within 10 seconds, begin to enter the new User PIN		<b>Blue</b> LED continues to blink
6. Press the KEY button twice (double-click)  		<b>Green</b> LED blinks
7. Within 10 seconds, begin to re-enter the new User PIN		<b>Green</b> LED continues to blink
8. Press the KEY button twice (double-click)  		<b>Red</b> solid LED changes to <b>Green</b> solid LED, indicating that the User PIN change was successful









**Note:** If you make a mistake while defining a new User PIN or do not complete the procedure, the drive will retain the old PIN.

## 5. How to enable Options

Options Mode allows you to perform different functions, such as enabling or disabling the DT2000 as 'Read-Only', setting a 'Timeout' automatic lock and determining the version of the device.

The table below illustrates how to access the Options mode, sections 6 - 9 describe how to perform the various functions.

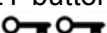
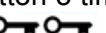
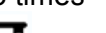





The table below illustrates how to access the Options mode, sections 6 - 9 describe how to perform the various functions.

Instructions	LED	LED State
1. Press KEY button once 		<b>Red, Green &amp; Blue</b> LEDs will flash together once and then the <b>Red</b> LED will continue to blink
2. Within 10 seconds, enter the User PIN (default - 11223344) to unlock the DT2000		<b>Red</b> LED will continue to blink
3. Press KEY button once 		<b>Red</b> solid LED changes to <b>Green</b> solid LED indicating successful User PIN entry
4. Press the KEY button 3 times (triple-click)   		<b>Green</b> and <b>Blue</b> LEDs blink together – awaiting new instructions in OPTIONS Mode.



## 6. How to enable Read-Only Mode

The DT2000 has a read-only mode that restricts write access to the drive. This is enabled by performing the following steps.

Instructions	LED	LED Status
1. Unlock DT2000 with the User PIN		<b>Red</b> solid LED changes to <b>Green</b> solid LED indicating successful User PIN entry
2. Enable Options by pressing the KEY button 3 times (triple-click) 		<b>Green</b> and <b>Blue</b> LEDs blink together – awaiting new instructions in OPTIONS Mode.
3. Within 10 seconds, begin to press number 7 ( <b>pqrs</b> ) followed by the number 6 ( <b>mno</b> ) button (76)		<b>Green</b> and <b>Blue</b> LEDs continue to blink together
4. Press KEY button once 		<b>Blue</b> LED quickly fades out to a solid <b>Green</b> - when DT2000 is inserted into a USB port, the <b>Green</b> LED blinks every two seconds indicating the drive is in Read-Only Mode





Once activated, access is limited to read-only until write protect is disabled.

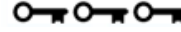

**Note:** We have applied a naming convention to make it easy for you to remember the keystrokes for each optional setting. In the table, above we have used numbers that represent the 'first letters' of the optional feature name. For example, **Read-Only** = 7 (**pqrs**) 6 (**mno**).

## 7. How to enable Read/Write Mode

Restricted write protect (read-only) access can be turned off with access restored to read/write. This is enabled by performing the following steps.

Instructions	LED	LED Status
1. Unlock DT2000 with the User PIN		<b>Red</b> solid LED changes to <b>Green</b> solid LED indicating successful User PIN entry
2. Enable Options by pressing the KEY button 3 times (triple-click) 		<b>Green</b> and <b>Blue</b> LEDs blink together – awaiting new instructions in OPTIONS Mode.
3. Within 10 seconds, enter the number 7 ( <b>pqrs</b> ) followed by the number 9 ( <b>wxyz</b> ) button (79)		<b>Green</b> and <b>Blue</b> LEDs continue to blink together
4. Press KEY button once 		<b>Blue</b> LED quickly fades out to a solid <b>Green</b> - when DT2000 is inserted into a USB port, the <b>Green</b> LED blinks every two seconds indicating the drive is in Read/Write Mode









Once activated, access is restored to the default read/write state.

## 8. How to set the Timeout Lock Mode

To protect against unauthorised access when the DT2000 is connected to a host and unattended, the DT2000 can be set to lock automatically after a pre-set amount of time.









In its default state, the DT2000 Timeout Lock feature is turned off. The Timeout Lock feature can be set to activate (lock) anywhere between 1 and 99 minutes.

To set the Timeout Lock, follow steps in the table below.







Instructions	LED	LED Status
1. Unlock the DT2000 with the User PIN		<b>Red</b> solid LED changes to <b>Green</b> solid LED indicating successful User PIN entry
2. Enable Options by pressing the KEY 3 button times (triple-click) 		<b>Green</b> and <b>Blue</b> LEDs blink together – awaiting new instructions in OPTIONS Mode
3. Within 10 seconds, enter the number <b>8</b> ( <b>tuv</b> ) followed by the number <b>5</b> ( <b>jkl</b> ) button - ( <b>85</b> )		<b>Green</b> and <b>Blue</b> LEDs continue to blink together
4. Press KEY button once 		Blinking <b>Green</b> LED
5. Within 10 seconds, enter the length of User Timeout in 2 digits: 00 = 0 minutes (default) 01 = 1 minute 99 = 99 minutes, etc.		<b>Green</b> LED continues to blink
6. Press the KEY button once 		<b>Green</b> solid LED - Timeout Lock has been enabled

## 9. How to disable the Timeout Lock Mode

To disable the Timeout Lock, follow steps in the table below.

Instructions	LED	LED Status
1. Unlock the DT2000 with the User PIN		<b>Red</b> solid LED changes to <b>Green</b> solid LED indicating successful User PIN entry
2. Enable Options by pressing the KEY 3 times (triple-click) 		<b>Green</b> and <b>Blue</b> LEDs blink together – awaiting new instructions in OPTIONS Mode
3. Within 10 seconds, enter the number <b>8</b> ( <b>tuv</b> ) followed by the number <b>5</b> ( <b>jkl</b> ) button - ( <b>85</b> )		<b>Green</b> and <b>Blue</b> LEDs continue to blink together
4. Press KEY button once 		Blinking <b>Green</b> LED
5. Within 10 seconds, enter the number <b>0</b> button twice (double-click) ( <b>zero zero</b> ) - ( <b>00</b> )		<b>Green</b> LED continues to blink
6. Press the KEY button once 		<b>Green</b> solid LED - Timeout Lock has been disabled

## 10. How to determine the DT2000 version number

Instructions	LED	LED Status
1. Unlock the DT2000 with the User PIN		<b>Red</b> solid LED changes to <b>Green</b> solid LED indicating successful User PIN entry
2. Enable Options by pressing the KEY button 3 times (triple-click) 		<b>Green</b> and <b>Blue</b> LEDs blink together – awaiting new instructions in OPTIONS Mode
3. Within 10 seconds, enter the number <b>8</b> (tuv) followed by the number <b>6</b> (mno) button - ( <b>86</b> )		<b>Green</b> and <b>Blue</b> LEDs continue to blink together
4. Press KEY button once 		<b>Red</b> , <b>Green</b> & <b>Blue</b> LEDs will quickly blink together once followed by the <b>Red</b> LED blinking to the first significant digit of the revision, then the <b>Green</b> LED will blink according to the second significant digit of the revision number
For example, if the revision is number '1.8', the <b>Red</b> LED will blink once (1) and the <b>Green</b> LED will blink eight (8) times. When the sequence has ended, the <b>Red</b> , <b>Green</b> and <b>Blue</b> LEDs will blink together once and then the <b>Green</b> will be solid.		

## 11. Brute force hacking detection



**Caution:** If you enter an incorrect User PIN 10 (ten) consecutive times, the DT2000's brute force mechanism will trigger and the User PIN, the encryption key and **all data** will be deleted and lost forever.

PIN used to unlock DT2000	What happens after 10 consecutive incorrect PIN entries?
User PIN	The DT2000 brute force mechanism will trigger and the User PIN, the encryption key and all data will be deleted and lost forever.

If you enter an incorrect PIN 10 (ten) consecutive times, the encryption key and all data will be deleted and lost forever. The DT2000 will then revert to the factory default User PIN of 11223344 - see section 4 on page 6 on how to change the User PIN. Also, since this will force the creation of a new encryption key, the DT2000 will have to be reformatted (see section 13 or 14).

Unlike other similar drives, the DT2000 incorporates a random number generator. Once the drive is reset, a new encryption key is randomly generated.









## 12. How to reset the DT2000

If you forget the User PIN or want to delete all data stored on the DT2000, follow the instructions below.

The reset process will clear all cryptographic parameters, including the User PIN. This means that the DT2000 will revert to the default User PIN of 11223344 - see section 4 on page 6 on how to change the User PIN. Also, since this will force the creation of a new encryption key, the DT2000 will have to be reformatted (see section 13 or 14).



**Caution:** Resetting the DT2000 will delete **all data** stored on the drive.

Instructions	LED	LED Status
1. Press and hold down the number <b>7</b> (pqrs) button and then press the KEY  button. Release buttons ( <b>7</b> &  )	 / 	<b>Red</b> and <b>Green</b> LEDs blink alternately
2. Within 10 seconds, press the number <b>9</b> (wxyz) button three times (triple-click) ( <b>999</b> )	 / 	<b>Red</b> and <b>Green</b> LEDs continue to blink alternately
3. Press and hold down number <b>7</b> (pqrs) button and then Press the KEY  button. Release buttons ( <b>7</b> &  )		<b>Red</b> LED fades out to complete the reset process

## 13. How to configure the DT2000 with Windows OS

If hacking detection has been triggered by entering the **incorrect PIN 10 times** in succession, or the drive has been **reset**, **all data on the drive will be lost forever**.

Once a new **User PIN** has been created, the DT2000 will need to be initialised and formatted.

**To initialise your DT2000, do the following:**

1. Create a new **User PIN** (see section 4).
2. Unlock the DT2000 by entering the new **User PIN** and connect it to a computer's USB port.
3. The computer should display the following message:

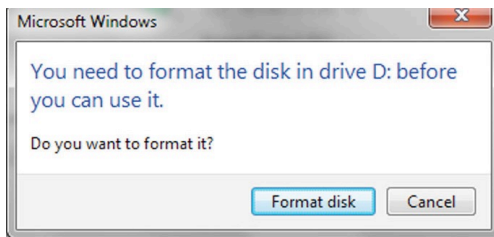

4. Proceed by clicking on **Format disk**. Select **FAT32** or **NTFS** depending on your needs, enter a **Volume Label** and click **Start**.

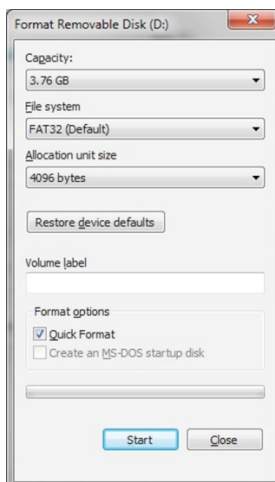

5. Click **OK** to continue with formatting the drive.

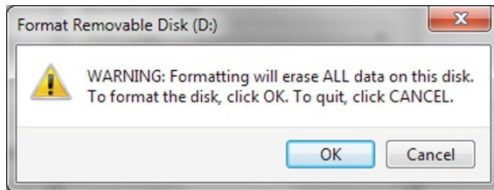

**Warning:** This procedure will erase **all data** stored on the drive.

6. The computer will finish formatting the drive and confirm that formatting has been completed. While the DT2000 is formatting, the **Blue** LED will flash.

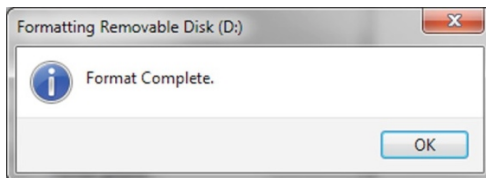

Once finished, the **Blue** LED becomes solid and your DT2000 is ready for use.

**If the formatting wizard does not appear, follow the procedure below:**

1. Right-click **My Computer** or **Computer** and then click **Manage**.
2. In the **Computer Management** window under the **Disk Management** tab, the DT2000 is recognised as a removable device in raw format.

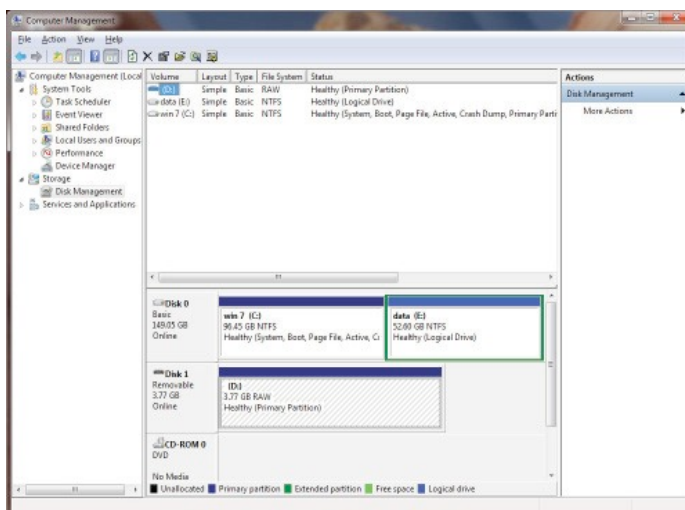

3. In the blank area under the unallocated section, right-click **Removable Raw Drive** and select **Format**.

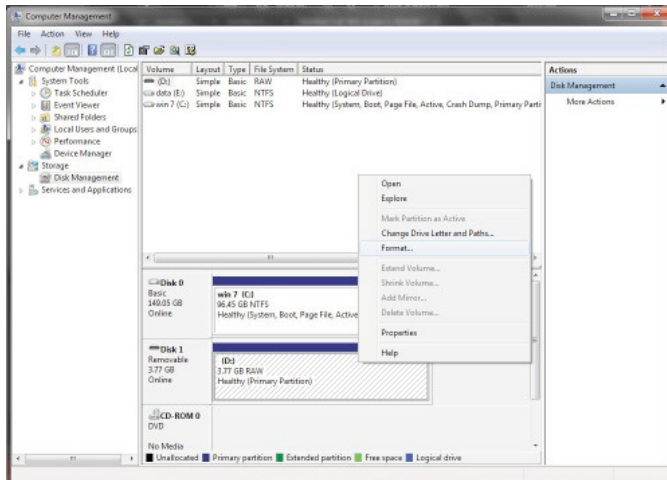

4. The **Format** window will open.  
Enter a new **Volume Label**.  
Select **FAT32** or **NTFS** depending on your needs and click **OK**.

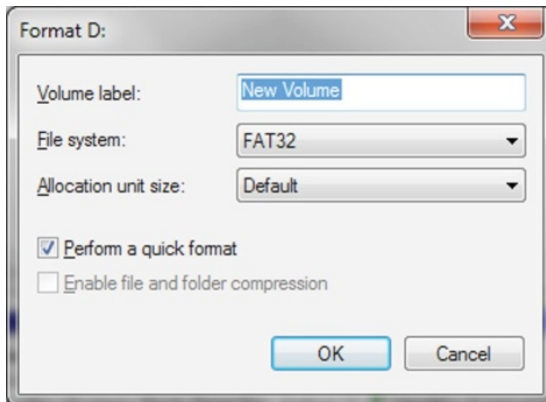

5. Click **OK** on the **Format** warning window to continue with formatting the drive.

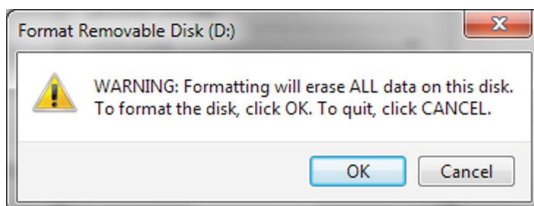

 **Warning:** This procedure will erase **all data** stored on the drive.

6. The computer will finish formatting and return to the **Disk Management** window.

While the DT2000 is formatting, the **Blue** LED will start flashing.

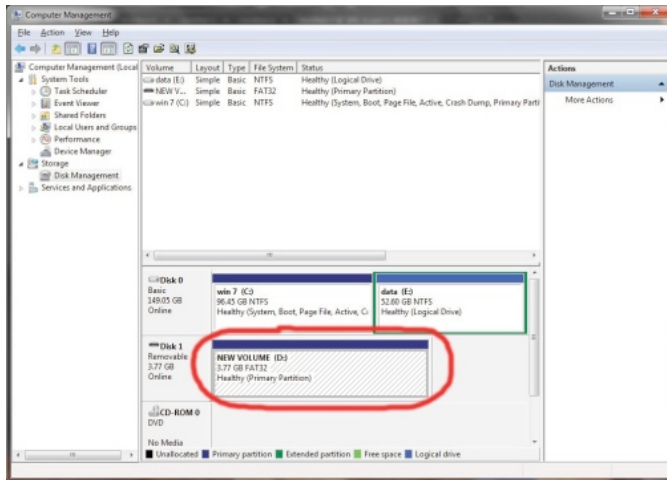

Once finished, the **Blue** LED becomes solid and your DT2000 is ready for use.

## 14. How to configure the DT2000 with Mac OS

If hacking detection has been triggered by entering the incorrect PIN 10 times in succession, or the drive has been reset, **all data on the drive will be lost forever**.

Once a new **User PIN** has been created, the DT2000 will need to be initialised and formatted.

To format your DT2000 on Mac OS computers, do the following:

1. Create a new **User PIN** (see section 4).
2. Unlock the DT2000 by entering the new **User PIN** and connect to a Mac computer's USB port. The system will prompt you with an **INITIALIZE** window.

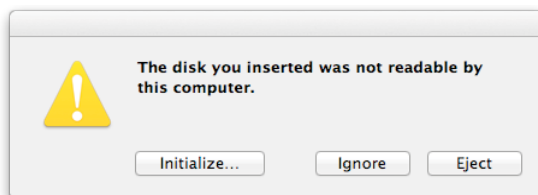



3. Press **INITIALIZE** and select the DT2000 in the **Disk Utility** window.

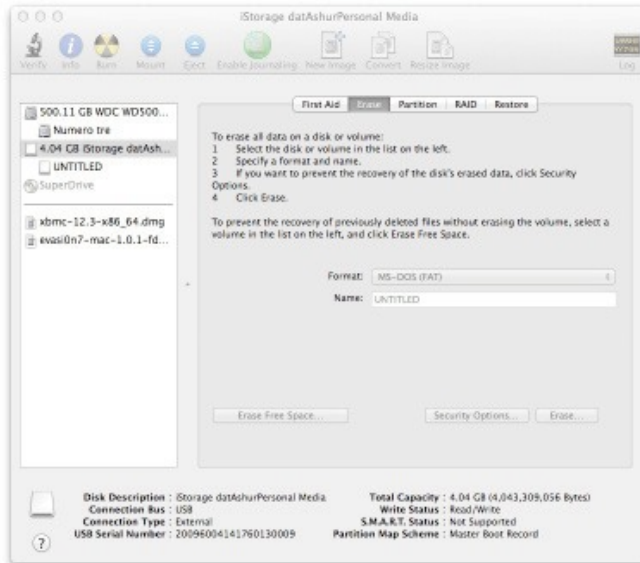

4. Click on the DT2000 on the left side of the **Disk Utility** window.
5. Choose **Erase** from the contextual menu on the right side of the window. Select **MS-DOS** for the **Volume Format**.
6. Click **Erase**.

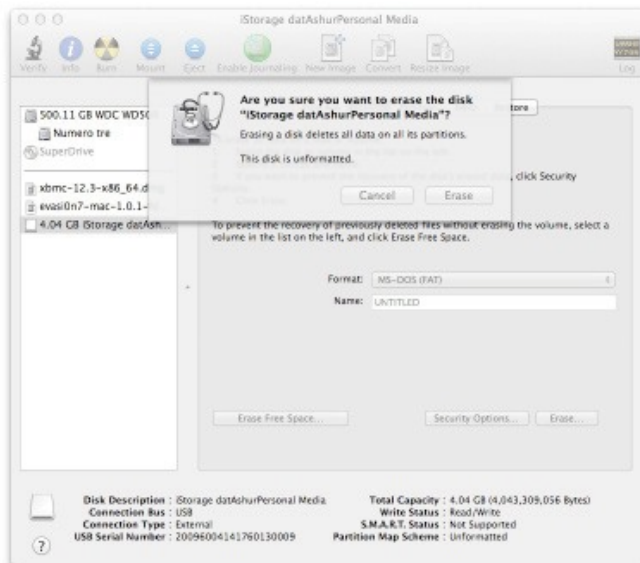

- The formatted DT2000 will appear in the **Disk Utility** window and will mount onto the desktop.

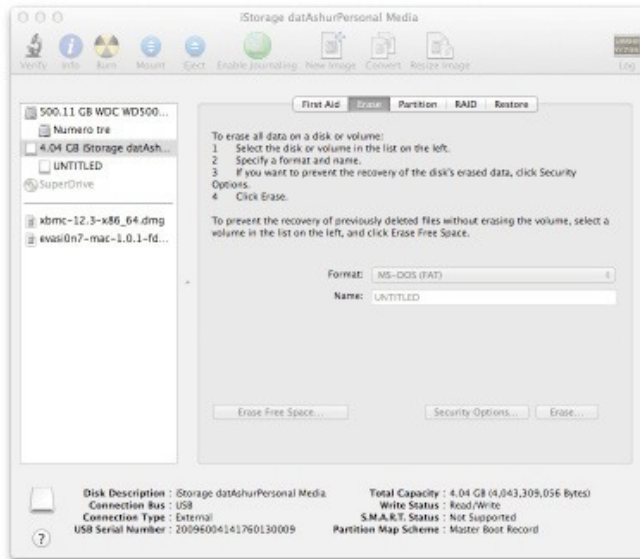

## Battery Information/ Product Disposal

Please do not dispose of your electrical or battery containing product waste with your normal household waste. Electronic products must be disposed of responsibly to minimise the environmental impact. Please do not try to remove the battery from the product; it may be removed only by Kingston or a professional service provider. Please [contact us](#) for more information on the battery and how to recycle the product responsibly.

DataTraveler® 2000 incorporates DataLock® Technology licensed from ClevX, LLC.

## DataTraveler® 2000 - Manual de usuario



**Recuerde anotar su número PIN en un lugar seguro. Si lo pierde o lo olvida, no habrá manera de tener acceso a los datos almacenados en la Kingston DataTraveler®.**

**Si tiene alguna dificultad consulte esta guía de usuario, que se encuentra en su DT2000 y también en el sitio web de Kingston: [kingston.com/support](http://kingston.com/support)**

Las DataTraveler® 2000 incorporan la tecnología DataLock® de ClevX, LLC, utilizada con licencia.

©2016 Kingston Technology Europe Ltd y Kingston Digital Europe Ltd, Kingston Court, Brooklands Close, Sunbury-on-Thames, Middlesex, TW16 7EP, Reino Unido. Tel: +44 (0) 1932 738888, Fax: +44 (0) 1932 785469. Todos los derechos reservados. Todos los nombres de empresas y marcas registradas son propiedad de sus respectivos dueños.



## Índice

Requisitos del sistema .....	3
Introducción.....	4
1. Disposición física de la DT2000 .....	5
2. Indicadores de LED y sus funciones .....	5
3. Uso de la DT2000 por primera vez.....	6
4. Cambio del número PIN del usuario.....	6
5. Habilitación de la modalidad de opciones .....	7
6. Activación de la función de solo lectura .....	8
7. Activación de la función de lectura/escritura .....	8
8. Uso de la función de bloqueo por tiempo de espera .....	9
9. Desactivación de la función de bloqueo por tiempo de espera .....	9
10. Determinación del número de versión de su DT2000 .....	10
11. Detección de ataques de fuerza bruta.....	10
12. Restablecimiento de la DT2000 .....	11
13. Configuración de la DT2000 en sistemas operativos Windows .....	12
14. Configuración de la DT2000 en sistemas operativos Mac .....	15



## Acerca de esta guía

Este manual de usuario corresponde a las unidades DataTraveler® 2000 de Kingston (a las que haremos referencia sencillamente como DT2000 a partir de ahora).

## Requisitos del sistema

---

### Plataforma Windows

### Sistemas operativos compatibles

- Windows 10
  - Windows 8/8.1
  - Windows 7
  - Windows Vista® SP2
- 

### Plataforma Mac

### Sistemas operativos compatibles

- Mac OS X 10.8.x - 10.11x
- 

### Plataforma Linux

### Sistemas operativos compatibles

- Linux v2.6 kernel+
- 

### Otras plataformas

### Sistemas operativos compatibles

- Chrome OS™, Android\*
- 

\*solo los dispositivos compatibles. Determine con el fabricante si su dispositivo es compatible con unidades USB de memoria Flash.

## Introducción



**Nota:** la batería recargable de su unidad DT2000 no estará totalmente cargada al momento de sacar la unidad de su envoltorio. Le recomendamos que recargue totalmente la batería antes de utilizar su unidad por primera vez. Para ello enchufe la DT2000 en un puerto USB provisto de alimentación de electricidad durante un lapso de 60 minutos.

Gracias por la compra de su unidad DataTraveler® 2000 USB 3.0 de memoria Flash, provista de cifrado basado en hardware y activada por número PIN.



La DT2000 utiliza cifrado XTS-AES de 256 bits basado en hardware, que cifra en tiempo real todos los datos que se almacenen en ellas. La DT2000 no requiere software, y su protección es independiente del sistema operativo y de los equipos en los que se utilizan.

Las unidades DT2000 cuentan con una batería recargable, que permite que los usuarios introduzcan (con el uso del teclado incorporado) un número PIN de identificación personal de 7 a 15 dígitos, antes de conectarlas a puertos USB.

En caso de pérdida o robo de su DT2000, el usuario puede estar seguro de que toda la información almacenada estará protegida y que personas no autorizadas no tendrán acceso a ella.

La DT2000 se desbloquea mediante su teclado incorporado, no a través de los equipos en los que se utiliza. No es vulnerable ante registradores de tecleo, ya sean de software o de hardware, ni ante ataques de fuerza bruta.









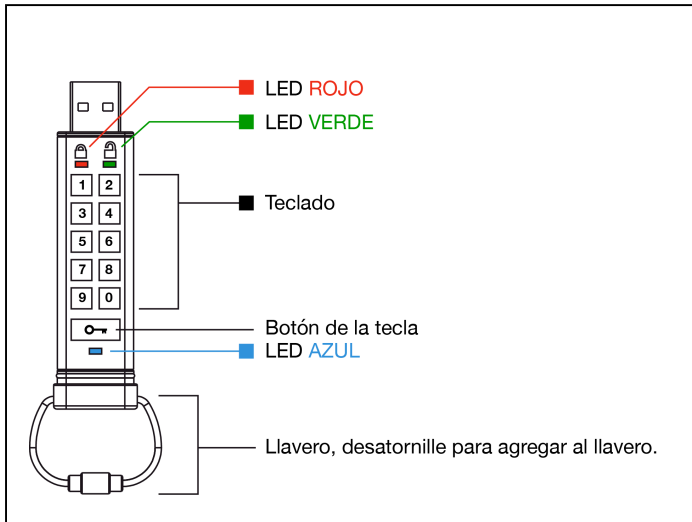







**Precaución:** La DT2000 se despacha de fábrica preconfigurada con el número PIN  1-1-2-2-3-3-4-4,  y aunque se puede utilizar inmediatamente con dicho PIN de fábrica, por motivos de seguridad **recomendamos encarecidamente que se configure de inmediato un nuevo número (“PIN del usuario”)**, siguiendo las instrucciones indicadas en la sección 4 “Cambio del número PIN del usuario”.

Si olvida su PIN no podrá tener acceso a la información almacenada.

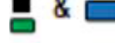
# 1. Disposición física de la DT2000







# 2. Indicadores de LED y sus funciones

LED	Estado del LED	Descripción	Estado del LED	Descripción	Descripción
	Apagado gradual del LED rojo 	En proceso de bloqueo, introducción de PIN incorrecto		Parpadeo alterno de los LED rojo y verde 	Restablecimiento a condiciones de fábrica
	Rojo parpadeante 	Bloqueada, a la espera de la introducción del PIN predeterminado de fábrica o del PIN del usuario			
	Verde encendido continuamente 	La DT2000 está desbloqueada		Verde y azul parpadeantes simultáneamente 	Modalidad de opciones de usuario
	Verde parpadeante 	Si la unidad DT2000 está conectada a un puerto USB y el LED de color verde parpadea cada 2 segundos es señal de que la unidad está configurada como de "solo lectura"			
	Azul encendido continuamente 	La unidad está conectada a un puerto USB			
	Azul parpadeante	Intercambio de datos con el equipo host/cambio de PIN en proceso			

### 3. Uso de la DT2000 por primera vez

La DT2000 se despacha de fábrica preconfigurada con el número PIN “1-1-2-2-3-3-4-4”, y aunque se puede utilizar inmediatamente con dicho PIN de fábrica, por motivos de seguridad recomendamos encarecidamente que se configure de inmediato un nuevo número (PIN del usuario), siguiendo las instrucciones indicadas en la sección 4 “Cambio del número PIN del usuario”.

Siga los tres sencillos pasos indicados en la tabla a continuación para desbloquear su DT2000 con el uso del número PIN de fábrica.

Instrucciones (uso por primera vez)	LED	Estado del LED
1. Pulse una vez el botón de la llave KEY 		Los LED de color <b>rojo</b> , <b>verde</b> y <b>azul</b> parpadearán simultáneamente, y luego el de color <b>rojo</b> permanecerá parpadeando
2. Antes de que transcurran 10 segundos comience a introducir en la unidad el PIN de fábrica (1-1-2-2-3-3-4-4) para desbloquear la DT2000		El LED de color <b>rojo</b> seguirá parpadeando
3. Pulse una vez el botón de la llave 		Se apagará el LED de color <b>rojo</b> y se encenderá continuamente el de color <b>verde</b> , para indicar que se ha introducido correctamente el PIN configurado en la unidad



**Nota:** una vez que se haya desbloqueado correctamente la unidad DT2000 el LED de color **verde** permanecerá encendido continuamente durante 30 segundos, lapso durante el cual se debe conectar la unidad a un puerto USB. Si desea volver a bloquear de inmediato la DT2000 puede mantener pulsando el botón de la llave  durante 3 segundos, puede esperar a que transcurra el lapso de 30 segundos, o también puede hacer clic en el icono ‘Quitar hardware de forma segura y expulsar el medio’ (Windows) o el equivalente del sistema operativo de su equipo.

### 4. Cambio del número PIN del usuario

Requisitos de los números PIN:

- Debe ser de una longitud de entre 7 y 15 dígitos
- No debe constar solamente de un mismo número repetido p. ej. (“3-3-3-3-3-3-3”)
- No debe constar solamente de números consecutivos p. ej., (“1-2-3-4-5-6-7”), (“7-8-9-0-1-2-3-4”), (“7-6-5-4-3-2-1”)





**Consejo acerca de los números PIN:** su número PIN puede corresponder a los caracteres y números de una palabra, nombre o frase que le sea fácil recordar. Pulse las teclas correspondientes a dichos caracteres y números para introducirlo.

Algunos ejemplos de esos tipos de números PIN alfanuméricos son

- En el caso del PIN “**miNoPIN**” las teclas serían las siguientes:  
7 (pqrs) 2 (abc) 7 (pqrs) 7 (pqrs) 9 (wxyz) 6 (mno) 7 (pqrs) 3 (def)
- En el caso del PIN “**kingston**” las teclas serían:  
5 (jkl) 4 (ghi) 6 (mno) 4 (ghi) 7 (pqrs) 8 (tuv) 6 (mno) 6 (mno)

Con el método anterior se puede crear números PIN de muchos dígitos y a la vez fáciles de recordar.



Instrucciones	LED	Estado del LED
1. Pulse una vez el botón de la llave 		Los LED de color <b>rojo</b> , <b>verde</b> y <b>azul</b> parpadearán simultáneamente, y luego el de color <b>rojo</b> permanecerá parpadeando
2. Antes de que transcurran 10 segundos, comience a introducir el PIN configurado en la unidad (el preconfigurado de fábrica es el “1-1-2-2-3-3-4-4”) para desbloquear la DT2000		El LED de color <b>rojo</b> seguirá parpadeando
3. Pulse una vez el botón de la llave 		Se apagará el LED de color <b>rojo</b> y se encenderá continuamente el de color <b>verde</b> , para indicar que se introdujo correctamente el PIN configurado en la unidad
4. Pulse dos veces (doble clic) el botón de la llave 		El LED de color <b>azul</b> se encenderá parpadeante
5. Antes de que transcurran 10 segundos comience a introducir el nuevo número PIN del usuario		El LED de color <b>azul</b> seguirá parpadeando
6. Pulse dos veces (doble clic) el botón de la llave 		El LED de color <b>verde</b> se encenderá parpadeante
7. Antes de que transcurran 10 segundos comience a introducir el nuevo número PIN del usuario		El LED de color <b>verde</b> seguirá parpadeando
8. Pulse dos veces (doble clic) el botón de la llave 		Se apagará el LED de color <b>Rojo</b> y se encenderá continuamente el de color <b>verde</b> , para indicar que se cambió correctamente el PIN del usuario









**Nota:** si se comete un error al definir el nuevo número PIN del usuario o si se interrumpe el procedimiento antes de finalizarlo, la unidad preservará el PIN antiguo.

## 5. Habilitación de la modalidad de opciones







La modalidad de cambio de opciones de usuario permite a los usuarios de las unidades DT2000 realizar ciertas configuraciones, tales como la activación y desactivación de las funciones de ‘solo lectura’ y de bloqueo automático por ‘tiempo de espera’, y también determinar la versión del dispositivo.

La tabla a continuación muestra la manera de tener acceso a la modalidad de opciones. Las secciones 6 a 9 describen la manera de utilizar las distintas funciones.

Instrucciones	LED	Estado del LED
1. Pulse una vez el botón de la llave 		Los LED de color <b>rojo</b> , <b>verde</b> y <b>azul</b> parpadearán simultáneamente, y luego el de color <b>rojo</b> permanecerá parpadeando
2. Antes de que transcurran 10 segundos comience a introducir el número PIN del usuario (el preconfigurado de fábrica es el “1-1-2-2-3-3-4-4”) para desbloquear la DT2000		El LED de color <b>rojo</b> seguirá parpadeando
3. Pulse una vez el botón de la llave 		Se apagará el LED de color <b>rojo</b> y se encenderá continuamente el de color <b>verde</b> , para indicar que se introdujo correctamente el PIN configurado en la unidad
4. Pulse tres veces (triple clic) el botón de la llave 		Los LED de color <b>verde</b> y de color <b>azul</b> parpadearán simultáneamente, para indicar que la unidad está en la modalidad de opciones y a la espera de instrucciones adicionales.

## 6. Activación de la función de solo lectura

Las unidades DT2000 cuentan con una función de solo lectura, que restringe el acceso de escritura a ellas. La activación de dicha función se hace mediante los siguientes pasos.

Instrucciones	LED	Estado del LED
1. Desbloquee la DT2000 con el PIN configurado		Se apagará el LED de color <b>rojo</b> y se encenderá continuamente el de color <b>verde</b> , para indicar que se introdujo correctamente el PIN configurado en la unidad
2. Pulse tres veces (triple clic)  el botón de la llave para habilitar la modalidad de opciones		Los LED de color <b>verde</b> y de color <b>azul</b> parpadearán simultáneamente, para indicar que la unidad está en la modalidad de opciones y a la espera de instrucciones adicionales.
3. Antes de que transcurran 10 segundos pulse el botón "7" ( <b>pqrs</b> ) y luego el botón "6" ( <b>mno</b> ) (76)		Los LED de color <b>verde</b> y <b>azul</b> seguirán parpadeando simultáneamente
4. Pulse una vez el botón de la llave 		Se apagará gradualmente el LED de color <b>azul</b> y se encenderá continuamente el de color <b>verde</b> . Cuando se inserte la unidad DT2000 en un puerto USB el LED de color <b>verde</b> parpadeará cada dos segundos, para indicar que la unidad tiene activada la función de solo lectura

Una vez activada dicha función, el acceso estará restringido a solo lectura hasta que se deshabilite la protección contra escritura.









**Nota:** hemos utilizado un esquema de nomenclatura (en inglés) que facilita que los usuarios recuerden las teclas correspondientes a cada una de las configuraciones de opciones. En la tabla anterior utilizamos nombres que representan las iniciales del nombre de las opciones (en inglés). Por ejemplo, **Read-Only** (solo lectura) = 7 (pqrs) 6 (mno).

## 7. Activación de la función de lectura/escritura

Se desactiva la función de acceso restringido de protección contra escritura (solo lectura) al activar la función de lectura y escritura.

Lo anterior se hace mediante los pasos a continuación.

Instrucciones	LED	Estado del LED
1. Desbloquee la DT2000 con el PIN configurado		Se apagará el LED de color <b>rojo</b> y se encenderá continuamente el de color <b>verde</b> , para indicar que se introdujo correctamente el PIN configurado en la unidad
2. Pulse tres veces (triple clic)  el botón de la llave para habilitar la modalidad de opciones		Los LED de color <b>verde</b> y de color <b>azul</b> parpadearán simultáneamente, para indicar que la unidad está en la modalidad de opciones y a la espera de instrucciones adicionales.
3. Antes de que transcurran 10 segundos pulse el botón 7 ( <b>pqrs</b> ) y luego el botón 9 ( <b>wxyz</b> ) (79)		Los LED de color <b>verde</b> y <b>azul</b> seguirán parpadeando simultáneamente
4. Pulse una vez el botón de la llave 		Se apagará gradualmente el LED de color <b>azul</b> y se encenderá continuamente el de color <b>verde</b> . Cuando se inserte la unidad DT2000 en un puerto USB el LED de color <b>verde</b> parpadeará cada dos segundos, para indicar que la unidad tiene activada la función de lectura/escritura









Una vez activada dicha función el acceso se restaurará al estado de lectura/escritura (predeterminado).

## 8. Uso de la función de bloqueo por tiempo de espera

A efectos de la protección contra el acceso no autorizado al estar la unidad DT2000 conectada a un equipo y sin vigilancia, se puede configurar la unidad para que se bloquee automáticamente después de un lapso de espera (a elegir).









En la configuración predeterminada de la DT2000 la función de bloqueo automático por tiempo de espera está desactivada. Al activar el bloqueo automático se puede configurar el lapso de espera a cualquier valor entre 1 y 99 minutos.

Para activar el bloqueo automático siga los pasos indicados en la tabla a continuación.







Instrucciones	LED	Estado del LED
1. Desbloquee la DT2000 con el PIN configurado		Se apagará el LED de color <b>rojo</b> y se encenderá continuamente el de color <b>verde</b> , para indicar que se introdujo correctamente el PIN configurado en la unidad
2. Pulse tres veces (triple clic) el botón de la llave para habilitar la modalidad de opciones 		Los LED de color <b>verde</b> y de color <b>azul</b> parpadearán simultáneamente, para indicar que la unidad está en la modalidad de opciones y a la espera de instrucciones adicionales.
3. Antes de que transcurran 10 segundos pulse el botón <b>8</b> (tuv) y luego el botón <b>5</b> (jkl) - (85)		Los LED de color <b>verde</b> y <b>azul</b> seguirán parpadeando simultáneamente
4. Pulse una vez el botón de la llave 		LED de color <b>verde</b> parpadeante
5. Antes de que transcurran 10 segundos introduzca la duración (2 dígitos) del lapso de espera, de esta forma: 00 = 0 minutos (predeterminado) 01 = 1 minuto 99 = 99 minutos, etc.		El LED de color <b>verde</b> seguirá parpadeando
6. Pulse una vez el botón de la llave 		LED de color <b>verde</b> encendido continuamente - se activó el bloqueo automático

## 9. Desactivación de la función de bloqueo por tiempo de espera

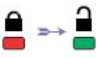
Para desactivar el bloqueo automático por tiempo de espera siga los pasos indicados en la tabla a continuación.

Instrucciones	LED	Estado del LED
1. Desbloquee la DT2000 con el PIN configurado		Se apagará el LED de color <b>rojo</b> y se encenderá continuamente el de color <b>verde</b> , para indicar que se introdujo correctamente el PIN configurado en la unidad
2. Pulse tres veces (triple clic) el botón de la llave para habilitar la modalidad de opciones 		Los LED de color <b>verde</b> y de color <b>azul</b> parpadearán simultáneamente, para indicar que la unidad está en la modalidad de opciones y a la espera de instrucciones adicionales.
3. Antes de que transcurran 10 segundos pulse el botón <b>8</b> (tuv) y luego el botón <b>5</b> (jkl) - (85)		Los LED de color <b>verde</b> y <b>azul</b> seguirán parpadeando simultáneamente
4. Pulse una vez el botón de la llave 		LED de color <b>verde</b> parpadeante
5. Antes de que transcurran 10 segundos pulse dos veces (doble clic) el botón <b>0</b> (cero cero) - (00)		El LED de color <b>verde</b> seguirá parpadeando
6. Pulse una vez el botón de la llave 		LED de color <b>verde</b> encendido continuamente - se deshabilitó el bloqueo automático

## 10. Determinación del número de versión de su DT2000

Instrucciones	LED	Estado del LED
1. Desbloquee la DT2000 con el PIN configurado		Se apagará el LED de color <b>rojo</b> y se encenderá continuamente el de color <b>verde</b> , para indicar que se introdujo correctamente el PIN configurado en la unidad
2. Pulse tres veces (triple clic) el botón de la llave para habilitar la modalidad de opciones 		Los LED de color <b>verde</b> y de color <b>azul</b> parpadearán simultáneamente, para indicar que la unidad está en la modalidad de opciones y a la espera de instrucciones adicionales.
3. Antes de que transcurran 10 segundos pulse el botón <b>8</b> (tuv) y luego el botón <b>6</b> (mno) - ( <b>86</b> )		Los LED de color <b>verde</b> y <b>azul</b> seguirán parpadeando simultáneamente
4. Pulse una vez el botón de la llave 	 	Los LED de color <b>rojo</b> , <b>verde</b> y <b>azul</b> parpadearán rápida y simultáneamente una vez, y luego permanecerá parpadeando el de color <b>rojo</b> hasta alcanzar el valor del dígito más significativo del número de la revisión; luego el LED de color <b>verde</b> parpadeará hasta alcanzar el dígito menos significativo de dicho número
Por ejemplo, si el número de la revisión es "1.8". el LED de color <b>rojo</b> parpadeara una (1) vez y el de color <b>verde</b> lo hará ocho (8) veces. Al finalizar la secuencia los LED de color <b>rojo</b> , <b>verde</b> y <b>azul</b> LED parpadearán simultáneamente una vez y luego permanecerá encendido el de color <b>verde</b> .		

## 11. Detección de ataques de fuerza bruta



**Precaución:** si el usuario introduce diez (10) veces uno o varios números PIN incorrectos se activará la función de protección contra ataques de fuerza bruta de la DT2000; y se borrará y perderá para siempre el PIN configurado, la clave de cifrado y **toda la información almacenada**.

PIN utilizado para desbloquear la DT2000	¿Qué ocurre después de 10 ingresos consecutivos de uno o varios números PIN incorrectos?
PIN configurado	Se activará la función de protección contra ataques de fuerza bruta de la DT2000, y se borrará y perderá para siempre el PIN configurado, la clave de cifrado y toda la información almacenada.

Si el usuario introduce diez (10) veces consecutivas uno o varios números PIN incorrectos se borrará y perderá para siempre la clave de cifrado y toda la información almacenada. La DT2000 restablecerá el PIN predeterminado de fábrica (1-1-2-2-3-3-4-4). Consulte la sección 4 en la página 6 para información acerca del cambio del número PIN configurado. Además, dado que lo anterior obligará la creación de una nueva clave de cifrado, se deberá volver a dar formato a la DT2000 (consulte la sección 13 o la sección 14).

Las unidades DT2000 de memoria Flash, a diferencia de las demás unidades, incorporan un generador de números aleatorios. Al restablecer la unidad se genera aleatoriamente la clave de cifrado.









## 12. Restablecimiento de la DT2000

Siga las instrucciones a continuación en caso de olvido del número PIN del usuario, y también si el usuario quiere borrar toda la información almacenada en la DT2000.

El proceso de restablecimiento borrará todos los parámetros criptográficos, incluyendo el PIN del usuario. Lo anterior significa que la DT2000 restablecerá el PIN predeterminado de fábrica (1-1-2-2-3-3-4-4). Consulte la sección 4 en la página 6 para información acerca del cambio del número PIN configurado. Además, dado que lo anterior obligará a la creación de una nueva clave de cifrado, se deberá volver a dar formato a la DT2000 (consulte la sección 13 o la sección 14).



**Precaución:** el restablecimiento de la unidad DT2000 borrará **toda la información** almacenada en ella.

Instrucciones	LED	Estado del LED
1. Pulse y mantenga pulsando el botón <b>7</b> (pqrs) y después pulse el botón de la llave  . Libere los botones ( <b>7</b> y  )	 / 	Los LED de color <b>rojo</b> y de color <b>verde</b> parpadearán alternadamente
2. Antes de que transcurran 10 segundos pulse tres veces (triple clic) el botón <b>9</b> (wxyz) ( <b>999</b> )	 / 	Los LED de color <b>rojo</b> y de color <b>verde</b> seguirán parpadearo alternadamente
3. Pulse y mantenga presionado el botón <b>7</b> (pqrs) y después pulse el botón de la llave  . Libere los botones ( <b>7</b> y  )		El LED de color <b>rojo</b> se apagará gradualmente para indicar la finalización del proceso de restablecimiento

## 13. Configuración de la DT2000 en sistemas operativos Windows

En el caso de que se detecte un ataque (mediante la introducción de uno o varios números **PIN incorrectos 10 veces** seguidas, y también si se **restableció** la unidad, **se producirá la pérdida para siempre de toda la información almacenada en ella.**

Luego de crear un nuevo **número PIN del usuario** se deberá volver a inicializar y dar formato a la unidad DT2000.

**El procedimiento de inicialización de las unidades DT2000 es el siguiente:**

1. Cree un nuevo **número PIN del usuario** (vea la sección 4).
2. Introduzca el nuevo **número PIN del usuario** para desbloquear la DT2000 y conéctela al puerto USB del ordenador.
3. El ordenador debe mostrar al usuario la notificación a continuación:

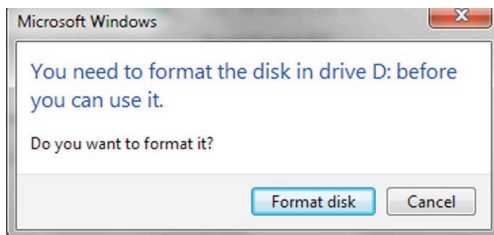

4. Proceda a hacer clic en **Formatear disco**. Seleccione **FAT32** o **NTFS** según sus necesidades, escriba una **Etiqueta del volumen** y haga clic en **Iniciar**.

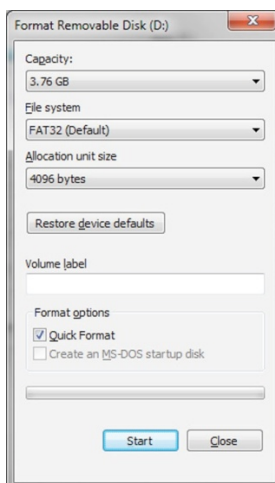

5. Haga clic en **Aceptar** para proceder a dar formato a la unidad.



**Advertencia:** este procedimiento borrará **toda la información** almacenada en la unidad.

6. El ordenador confirmará la finalización del formateo de la unidad al terminar el proceso. Durante el formateo de la DT2000 el LED de color **azul** se encenderá parpadeante.

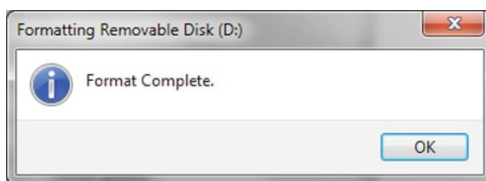

Una vez finalizado el proceso el LED de color **azul** permanecerá encendido, para indicar que la DT2000 está lista para su uso.

**Si no se muestra el asistente de formateo, siga el procedimiento a continuación:**

1. Haga clic con el botón de la derecha en **Mi PC** o en **PC** y después haga clic en **Administrar**.
2. En la ventana **Administración de equipos** en la ficha **Administración de discos** se indicará que se reconoce a la unidad DT2000 como un dispositivo extraíble de formato del tipo sin procesar.

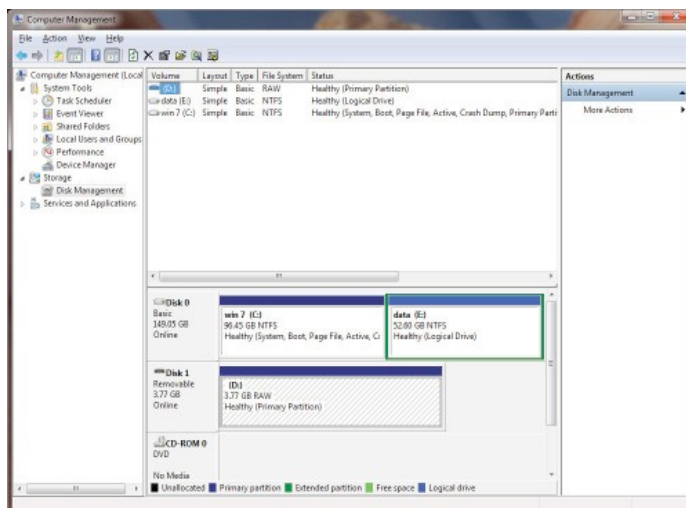

3. En la zona vacía bajo la sección “No asignado”, haga clic con el botón de la derecha en **Unidad extraíble sin procesar** y seleccione **Formato** (o leyendas/comandos similares).

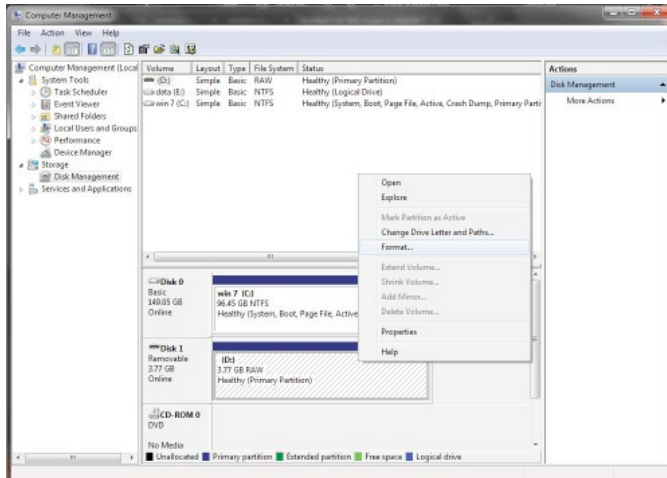

4. Se abrirá la ventana **Formato** (o de nombre similar). Introduzca una nueva **Etiqueta del volumen**. Seleccione **FAT32** o **NTFS** según sus necesidades y haga clic en **Aceptar**.

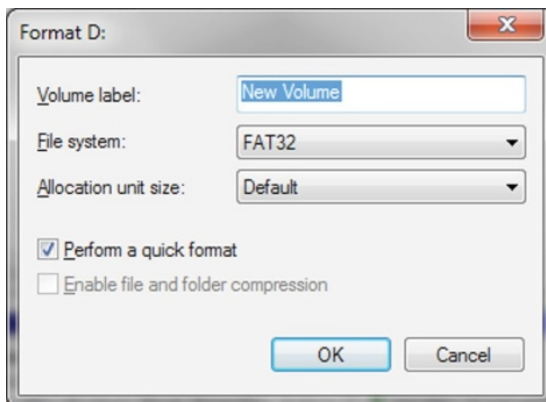

5. Haga clic en **Aceptar** en la ventana **Formato** (o de nombre similar) de advertencia para proceder al formateo de la unidad.

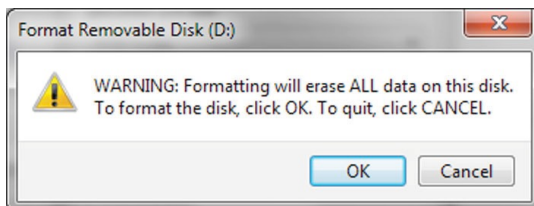

**Advertencia:** este procedimiento borrará  **toda la información**  almacenada en la unidad.



6. El ordenador finalizará el formateo de la unidad y regresará a la ventana **Administración de discos**.

Durante el formateo de la DT2000 el LED de color **azul** se encenderá parpadeante.

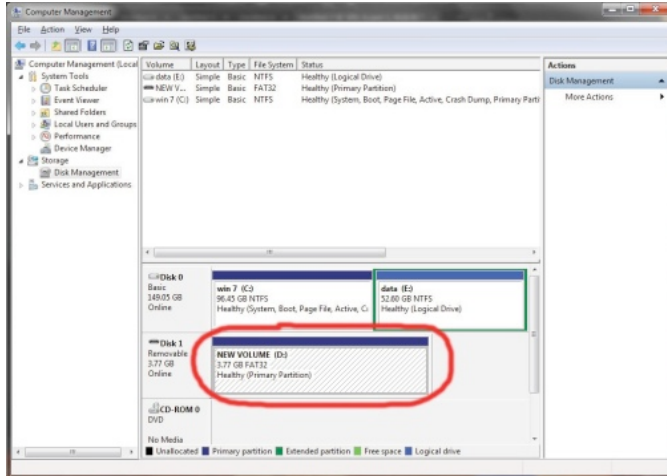

Una vez finalizado el proceso el LED de color **azul** permanecerá encendido, para indicar que la DT2000 está lista para su uso.

## 14. Configuración de la DT2000 en sistemas operativos Mac

En el caso de que se detecte un ataque mediante la introducción de uno o varios números PIN incorrectos 10 veces seguidas, y también si se restableció la unidad, **toda la información almacenada en ella se perderá para siempre**.

Luego de crear un nuevo **número PIN del usuario** se deberá volver a inicializar y dar formato a la unidad DT2000.

Para dar formato a la DT2000 en ordenadores de sistema operativo Mac siga los pasos a continuación:

1. Cree un nuevo **número PIN del usuario** (vea la sección 4).
2. Introduzca el nuevo **número PIN del usuario** para desbloquear la DT2000 y conéctela al puerto USB del ordenador. El ordenador le mostrará la ventana **INICIALIZAR**.



3. Pulse **INICIALIZAR** y seleccione la DT2000 en la ventana **Utilidad de discos**.

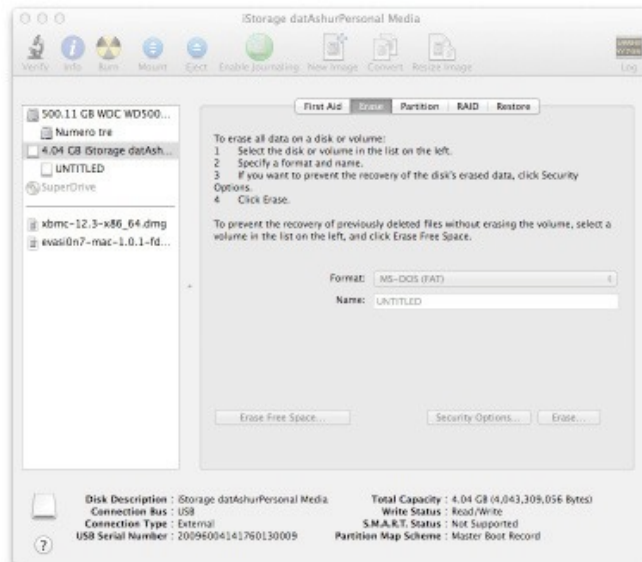

4. Haga clic en la DT2000 al lado izquierdo de la ventana **Utilidad de discos**.
5. Seleccione **Borrar** en el menú contextual al lado derecho de la ventana. Seleccione la opción **MS-DOS** del **Formato del volumen**.
6. Haga clic en **Borrar**.

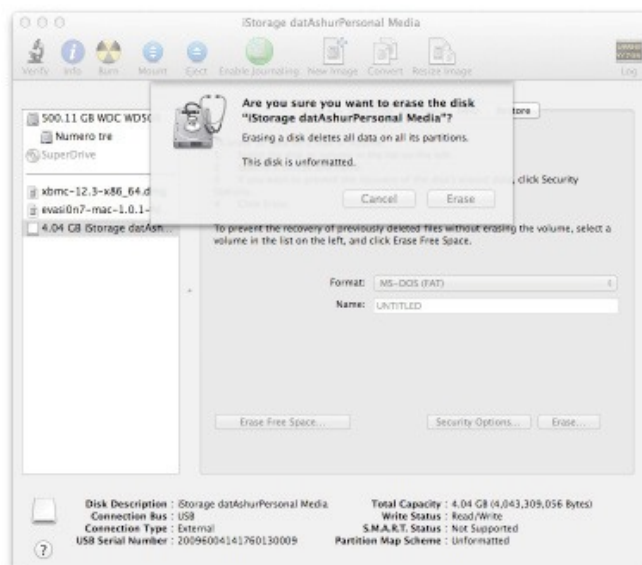

7. La unidad DT2000 ya formateada se mostrará en la ventana de la **Utilidad de discos** y se montará en el escritorio.

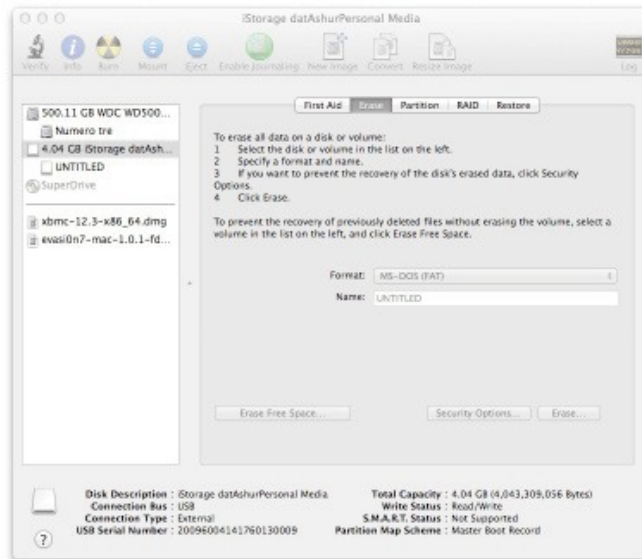

## Información sobre la batería/eliminación de productos

No elimine productos eléctricos o que contengan baterías junto con sus residuos domésticos normales. Los productos electrónicos deben desecharse de forma responsable para minimizar el impacto medioambiental. No intente retirar la batería del producto, esto solo puede hacerlo Kingston o un proveedor de servicios profesional. [Póngase en contacto con nosotros](#) para obtener más información sobre la batería y sobre cómo reciclar el producto de forma responsable..

Las DataTraveler<sup>®</sup> 2000 incorporan la tecnología DataLock<sup>®</sup> de ClevX, LLC, utilizada con licencia.

## DataTraveler® 2000 - Benutzerhandbuch



**Vergessen Sie nicht, Ihre PIN an einem sicheren Ort aufzubewahren. Wenn sie verloren oder vergessen wurde, gibt es keine Möglichkeit mehr, auf die Daten zuzugreifen, die auf Ihrem Kingston DataTraveler® gespeichert sind.**

**Sollten Probleme auftreten, lesen Sie bitte das vollständige Benutzerhandbuch auf Ihrem DT2000, oder alternativ auf Kingstons Website: [kingston.com/support](http://kingston.com/support)**

DataTraveler® 2000 mit DataLock® Technologie unter Lizenz von ClevX, LLC.

©2016 Kingston Technology Europe Ltd und Kingston Digital Europe Ltd, Kingston Court, Brooklands Close, Sunbury-on-Thames, Middlesex, TW16 7EP, England. Tel: +44 (0) 1932 738888, Fax: +44 (0) 1932 785469. Alle Rechte vorbehalten. Alle Marken und eingetragenen Marken sind Eigentum ihrer jeweiligen Besitzer.



## Inhalt

Systemvoraussetzungen .....	3
Einführung .....	4
1. DT2000 Layout.....	5
2. LED-Anzeigen und ihr Effekt.....	5
3. Erste Verwendung Ihres DT2000 .....	6
4. So ändern Sie Ihre PIN .....	6
5. So aktivieren Sie Optionen.....	7
6. So aktivieren Sie den Schreibschutzmodus .....	8
7. So deaktivieren Sie den Schreibschutzmodus.....	8
8. So stellen Sie die Timeout-Sperrfunktion ein .....	9
9. So deaktivieren Sie die Timeout-Sperrfunktion .....	9
10. So finden Sie die DT2000 Versionsnummer .....	10
11. Brute Force Hacker entdecken.....	10
12. So setzen Sie den DT2000 zurück.....	11
13. So konfigurieren Sie den DT2000 unter dem Windows BS.....	12
14. So konfigurieren Sie den DT2000 unter dem Mac BS .....	15



## Über diese Bedienungsanleitung

Diese Bedienungsanleitung gilt für den DataTraveler® 2000 (zur Vereinfachung nachstehend DT2000).

## Systemvoraussetzungen

---

### PC-Plattform

### Unterstützte PC-Betriebssysteme

- Windows 10
  - Windows 8 & 8.1
  - Windows 7
  - Windows Vista® SP2
- 

### Mac Plattform

### Unterstütztes Betriebssystem

- Mac OS X 10.8.x - 10.11x
- 

### Linux Plattform

### Unterstütztes Betriebssystem

- Linux ab Kernel V2.6
- 

### Weitere Plattformen

### Unterstützte Betriebssysteme

- Chrome OS™, Android\*
- 

\*Nur mit kompatiblen Geräten Erkundigen Sie sich beim Hersteller, ob Ihr Gerät USB-Flashspeicher unterstützt.

## Einführung



**Hinweis:** Wenn Sie Ihren DT2000 kaufen, ist sein Akku nicht vollständig aufgeladen. Wir empfehlen, den Akku vor der ersten Verwendung voll zu laden. Stecken Sie den DT2000 dazu 60 Minuten lang in einen an einer Stromquelle eingesteckten USB-Anschluss ein.

Wir freuen uns, dass Sie sich für einen DataTraveler® 2000 entschieden haben, den ultrasicheren, benutzerfreundlichen USB 3.0 Flashspeicher, der sich durch Hardware-Verschlüsselung und PIN-Abfrage auszeichnet.



Der DT2000 wird mit XTS-AES 256-Bit Hardware-Verschlüsselung nach Militärstandard geschützt, bei dem alle auf dem Laufwerk gespeicherten Daten in Echtzeit verschlüsselt werden. Für den DT2000 ist keine Software erforderlich und er läuft unabhängig vom BS und Host.

Im DT2000 ist eine wiederaufladbare Batterie integriert, damit der Benutzer vor dem Anschließen den Speichers an einen USB-Anschluss auf der Tastatur eine PIN (persönliche Identifikationsnummer) aus 7 bis 15 Zeichen eingeben kann.

Der Benutzer kann sich sicher sein, dass sein DT2000 bei einem Verlust oder Diebstahl nicht von einer unbefugten Person verwendet werden kann.

Der DT2000 wird über die interne Tastatur entsperrt und nicht über den Hostcomputer. Er ist somit nicht durch Key-Logger, oder Brute Force Attacken, angreifbar, die auf Software- oder Hardware-Basis arbeiten.









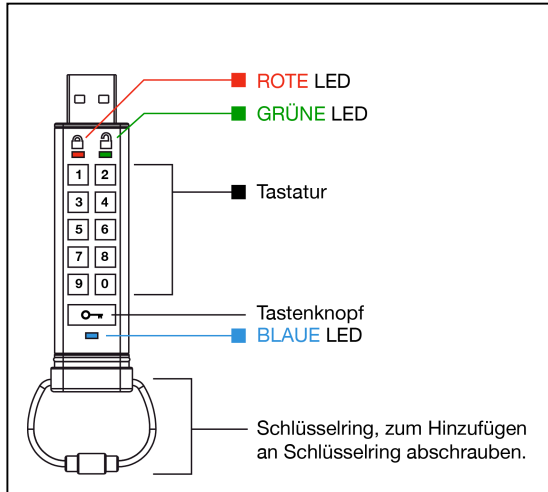







**Achtung:** Der DT2000 wird mit der folgenden standardmäßigen Benutzer-PIN geliefert:  1-1-2-2-3-3-4-4  Er kann zwar nach dem Auspacken sofort mit dieser Standard-PIN benutzt werden, jedoch empfehlen wir aus Sicherheitsgründen **dringend, eine neue, benutzerdefinierte PIN zu erstellen**. Befolgen Sie dazu Abschnitt 4 „So ändern Sie Ihre PIN“.

Wenn Sie Ihre PIN vergessen haben, können Sie nicht mehr auf Ihre Daten zugreifen.

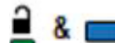
# 1. DT2000 Layout



# 2. LED-Anzeigen und ihr Effekt





LED	LED-Status	Bezeichnung	LED-Status	Bezeichnung	Bezeichnung
	<b>Rot Schwarz</b> erlöschen. 	Herunterfahren wg/ inkorrektener PIN-Eingabe.		<b>Rot und Grün</b> blinken abwechselnd. 	Zurücksetzen auf Werkseinstellungen.
	<b>Rot</b> blinkt. 	Gesperrt und wartet auf Eingabe der werkseitigen oder einer definierten PIN.			
	<b>Grün</b> leuchtet durchgehend. 	Der DT2000 ist freigegeben.		<b>Grün und Blau</b> blinken gleichzeitig. 	Benutzeroptionmodus
	<b>Grün</b> blinkt. 	Wenn der DT2000 in einem USB-Anschluss eingesteckt ist und die LED alle 2 Sekunden <b>Grün</b> blinkt, bedeutet dies, dass er im schreibgeschützten Modus arbeitet.			
	<b>Blau</b> durchgehend 	In einen USB-Anschluss eingesteckt.			
	<b>Blau</b> blinkt.	Datenaustausch mit einem Host bzw. Änderung der Benutzer-PIN.			



### 3. Erste Verwendung Ihres DT2000

Serienmäßig ist der DT2000 auf die PIN 11223344 eingestellt. Er kann zwar sofort nach dem Auspacken mit dieser PIN verwendet werden, aus Sicherheitsgründen empfehlen wir jedoch dringend, sofort eine neue PIN zu erstellen. Befolgen Sie dazu die Anleitung in Abschnitt 4 „So ändern Sie die Benutzer-PIN“.

Entsperren Sie den DT2000 bitte mit der standardmäßigen PIN, wie in den ein 3 einfachen Schritten in der nachstehenden Tabelle angegeben.

Anleitung (erste Verwendung)	LED	LED-Status
1. Drücken Sie einmal auf den Tastenkopf. 		<b>Rot, Grün &amp; Blau</b> blinken gleichzeitig einmal auf, danach blinkt nur noch die <b>rote</b> LED.
2. Geben Sie nun die serienmäßige Benutzer-PIN (standardmäßig 11223344) ein, um den DT2000 zu entsperren.		Die <b>rote</b> LED blinkt weiterhin.
3. Drücken Sie einmal auf den Tastenkopf. 		Die <b>rote</b> durchgehend leuchtende LED wechselt auf <b>Grün</b> , wodurch angezeigt wird, dass die Eingabe der Benutzer-PIN erfolgreich war.



**Hinweis:** Nachdem der DT2000 entsperrt wurde, muss er innerhalb von 30 Sekunden in einen USB-Anschluss eingesteckt werden. Während dieses Zeitraums leuchtet die **grüne** LED durchgehend. Der DT2000 kann sofort gesperrt werden. Halten Sie dazu den Tastenkopf  3 Sekunden lang gedrückt, oder warten Sie bis die 30 Sekunden abgelaufen sind. Alternativ können Sie im Betriebssystem auf das Symbol 'Hardware sicher entfernen und Medium auswerfen' klicken.

### 4. So ändern Sie Ihre PIN

Bedingungen für die PIN:













- Muss zwischen 7 und 15 Ziffern lang sein.
- Darf nicht nur aus sich wiederholenden Ziffern bestehen, z. B. (3-3-3-3-3-3-3)
- Darauf nicht nur aus Nummernfolgen bestehen, z. B. (1-2-3-4-5-6-7), (7-8-9-0-1-2-3-4), (7-6-5-4-3-2-1)

**Passwort-Tipp:** Erstellen Sie ein Wort, einen Namen oder Satz, oder eine alphanumerische Kombination, die Sie sich leicht als PIN merken können, indem Sie auf die Tasten mit den entsprechenden Buchstaben drücken.

Alphanumerische PINs wären beispielsweise:

- Für „**passwort**“ würden Sie beispielsweise auf folgende Tasten drücken:  
7 (pqr) 2 (abc) 7 (pqr) 7 (pqr) 9 (wxyz) 6 (mno) 7 (pqr) 8 (tuv)
- Für „**kingston**“ würden Sie drücken auf:  
5 (jkl) 4 (ghi) 6 (mno) 4 (ghi) 7 (pqr) 8 (tuv) 6 (mno) 6 (mno)

Mit dieser Methode können lange, leicht erinnerliche PINs erstellt werden.

Anleitung	LED	LED-Status
1. Drücken Sie einmal auf den Tastenknopf. 		<b>Rot, Grün &amp; Blau</b> blinken gleichzeitig einmal auf, danach blinkt nur noch die <b>rote</b> LED.
2. Beginnen Sie innerhalb von 10 Sekunden mit der Eingabe der serienmäßigen Benutzer-PIN (standardmäßig 11223344), um den DT2000 zu entsperren.		Die <b>rote</b> LED blinkt weiterhin.
3. Drücken Sie einmal auf den Tastenknopf. 		Die <b>rote</b> durchgehend leuchtende LED wechselt auf <b>Grün</b> , wodurch angezeigt wird, dass die Eingabe der Benutzer-PIN erfolgreich war.
4. Drücken Sie zweimal auf den Tastenknopf. (Doppelklick) 		Die <b>blaue</b> LED blinkt.
5. Beginnen Sie innerhalb von 10 Sekunden mit der Eingabe der Neuen Benutzer-PIN.		Die <b>blaue</b> LED blinkt weiterhin.
6. Drücken Sie zweimal auf den Tastenknopf. (Doppelklick) 		Die <b>grüne</b> LED blinkt.
7. Beginnen Sie innerhalb von 10 Sekunden mit der Eingabe der Neuen Benutzer-PIN.		Die <b>grüne</b> LED blinkt weiterhin.
8. Drücken Sie zweimal auf den Tastenknopf. (Doppelklick) 		Die <b>rote</b> durchgehend leuchtende LED wechselt auf <b>Grün</b> , wodurch angezeigt wird, dass die Änderung der Benutzer-PIN erfolgreich war.









**Hinweis:** Wenn bei der Festlegung einer neuen Benutzer-PIN ein Fehler unterlaufen, oder die Eingabe nicht abgeschlossen wurde, behält der Speicher die alte PIN bei.

## 5. So aktivieren Sie Optionen







Im Optionsmodus kann der Benutzer verschiedene Funktionen durchführen, wie Aktivieren und Deaktivieren des „Schreibschutzmodus“ für den DT2000, Einstellen einer automatischen „Timeout-Sperre“, und die Geräteversion abrufen.

In der nachstehenden Tabelle wird gezeigt, wie Sie den Optionsmodus aufrufen können. In den Abschnitten 6 - 9 ist beschrieben, wie Sie die einzelnen Funktionen aktivieren können.

Anleitung	LED	LED-Status
1. Drücken Sie einmal auf den Tastenknopf. 		<b>Rot, Grün &amp; Blau</b> blinken gleichzeitig einmal auf, danach blinkt nur noch die <b>rote</b> LED.
2. Geben Sie die Benutzer-PIN innerhalb von 10 Sekunden ein. (standardmäßig - 11223344) um den DT2000 zu entsperren.		Die <b>rote</b> LED blinkt weiterhin.
3. Drücken Sie einmal auf den Tastenknopf. 		Die <b>rote</b> durchgehend leuchtende LED wechselt auf <b>Grün</b> , wodurch angezeigt wird, dass die Eingabe der Benutzer-PIN erfolgreich war.
4. Drücken Sie dreimal auf den Tastenknopf. (Dreifachklick) 		Die <b>grüne</b> und <b>blaue</b> LED blinken gleichzeitig und warten auf neue Anweisungen im OPTIONS-Modus.

## 6. So aktivieren Sie den Schreibschutzmodus

Der DT2000 verfügt über einen Schreibschutzmodus für den eingeschränkten Zugriff auf das Laufwerk. Dieser wird durch folgende Schritte aktiviert.

Anleitung	LED	LED-Status
1. Entsperren Sie den DT2000 mit Ihrer Benutzer-PIN.		Die <b>rote</b> durchgehend leuchtende LED wechselt auf <b>Grün</b> , wodurch angezeigt wird, dass die Eingabe der Benutzer-PIN erfolgreich war.
2. Drücken Sie zum Aufrufen der Optionen dreimal auf den Tastenknopf. (Dreifachklick) 		Die <b>grüne</b> und <b>blaue</b> LED blinken gleichzeitig und warten auf neue Anweisungen im OPTIONS-Modus.
3. Beginnen Sie innerhalb von 10 Sekunden, auf die Zahl 7 ( <b>pqrs</b> ) und danach auf die Zahl 6 ( <b>mno</b> ) (76) zu drücken.		<b>Grün</b> und <b>Blau</b> blinken gleichzeitig.
4. Drücken Sie einmal auf den Tastenknopf. 		Die <b>blaue</b> LED erlischt schnell und wird durch ein durchgehend leuchtendes <b>Grün</b> ersetzt. Wenn der DT2000 im Schreibschutzmodus in einen USB-Anschluss eingesteckt wird, blinkt die <b>grüne</b> LED alle 2 Sekunden, um anzuzeigen, dass das Laufwerk im Schreibschutzmodus arbeitet.







Nach der Aktivierung des Schreibschutzes ist der Zugang auf „Nur Lesen“ begrenzt, bis der Schreibschutz wieder aufgehoben wurde.



**Hinweis:** Wir haben eine Benennungsregel installiert, die es dem Benutzer vereinfacht, sich die Tastendrücke für jede optionale Einstellung zu merken. In der vorstehenden Tabelle haben wir die Zahlen verwendet, die für die 'ersten Buchstaben' der optionalen Funktion (in englischer Sprache) stehen. Beispielsweise: **Read-Only** = 7 (**pqrs**) 6 (**mno**).

## 7. So deaktivieren Sie den Schreibschutzmodus

Um Zugang im Schreibmodus zu erhalten, kann der schreibgeschützte Zugang (Nur Lesen) deaktiviert werden. Dieser wird durch die folgende Schritte deaktiviert.

Anleitung	LED	LED-Status
1. Entsperren Sie den DT2000 mit Ihrer Benutzer-PIN.		Die <b>rote</b> durchgehend leuchtende LED wechselt auf <b>Grün</b> , wodurch angezeigt wird, dass die Eingabe der Benutzer-PIN erfolgreich war.
2. Drücken Sie zum Aufrufen der Optionen dreimal auf den Tastenknopf. (Dreifachklick) 		Die <b>grüne</b> und <b>blaue</b> LED blinken gleichzeitig und warten auf neue Anweisungen im OPTIONS-Modus.
3. Geben Sie innerhalb von 10 Sekunden die Zahl 7 ( <b>pqrs</b> ) gefolgt von der Zahl 9 ( <b>wxyz</b> ) Taste ( <b>79</b> ) ein.		<b>Grün</b> und <b>Blau</b> blinken gleichzeitig.
4. Drücken Sie einmal auf den Tastenknopf. 		Die <b>blaue</b> LED erlischt und wird durch ein durchgehend leuchtendes <b>Grün</b> ersetzt. Wenn der DT2000 in einen USB-Anschluss eingesteckt wird, blinkt die <b>grüne</b> LED alle 2 Sekunden, um anzuzeigen, dass das Laufwerk im Schreibmodus arbeitet.







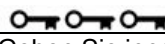

Nach seiner Aktivierung kann wieder im Schreibmodus auf das Laufwerk zugegriffen werden.

## 8. So stellen Sie die Timeout-Sperrfunktion ein

Wenn der DT2000 in einem Hostgerät eingesteckt ist und nicht bedient wird, kann er gegen unbefugten Zugriff geschützt werden. Der DT2000 kann so eingestellt werden, dass er nach einem festgelegten Zeitraum automatisch gesperrt wird.









Serienmäßig ist die Timeout-Sperrfunktion des DT2000 ausgeschaltet. Die Timeout-Funktion kann zur automatischen Sperre in einem Zeitraum zwischen 1 und 99 Minuten eingestellt werden.

Zum Einstellen der Timeout-Sperrfunktion befolgen Sie bitte die Schritte in der nachstehenden Tabelle.







Anleitung	LED	LED-Status
1. Entsperren Sie den DT2000 mit Ihrer Benutzer-PIN.		Die <b>rote</b> durchgehend leuchtende LED wechselt auf <b>Grün</b> , wodurch angezeigt wird, dass die Eingabe der Benutzer-PIN erfolgreich war.
2. Drücken Sie zum Aufrufen der Optionen dreimal auf den Tastenknopf. (Dreifachklick) 		Die <b>grüne</b> und <b>blaue</b> LED blinken gleichzeitig und warten auf neue Anweisungen im OPTIONS-Modus.
3. Geben Sie innerhalb von 10 Sekunden die Zahl <b>8</b> (tuv) ein, gefolgt von der Zahl <b>5</b> (jkl) - ( <b>85</b> )		<b>Grün</b> und <b>Blau</b> blinken gleichzeitig.
4. Drücken Sie einmal auf den Tastenknopf. 		Die <b>grüne</b> LED beginnt zu blinken.
5. Geben Sie innerhalb von 10 Sekunden die Länge der Benutzer-Timeout mit 2 Ziffern ein: 00 = 0 Minuten (Standard) 01 = 1 Minute 99 = 99 Minuten usw.		Die <b>grüne</b> LED blinkt weiterhin.
6. Drücken Sie einmal auf den Tastenknopf. 		Die durchgehend <b>grüne</b> LED zeigt an, dass die Timeout-Sperre aktiviert ist.

## 9. So deaktivieren Sie die Timeout-Sperrfunktion

Zum Deaktivieren der Timeout-Sperrfunktion befolgen Sie bitte die Schritte in der nachstehenden Tabelle.

Anleitung	LED	LED-Status
1. Entsperren Sie den DT2000 mit Ihrer Benutzer-PIN.		Die <b>rote</b> durchgehend leuchtende LED wechselt auf <b>Grün</b> , wodurch angezeigt wird, dass die Eingabe der Benutzer-PIN erfolgreich war.
2. Drücken Sie zum Aufrufen der Optionen dreimal auf den Tastenknopf. (Dreifachklick) 		Die <b>grüne</b> und <b>blaue</b> LED blinken gleichzeitig und warten auf neue Anweisungen im OPTIONS-Modus.
3. Geben Sie innerhalb von 10 Sekunden die Zahl <b>8</b> (tuv) ein, gefolgt von der Zahl <b>5</b> (jkl) - ( <b>85</b> )		<b>Grün</b> und <b>Blau</b> blinken gleichzeitig.
4. Drücken Sie einmal auf den Tastenknopf. 		Die <b>grüne</b> LED beginnt zu blinken.
5. Geben Sie innerhalb von 10 Sekunden die Zahl <b>0</b> zweimal ein (Doppelklick) ( <b>00</b> ) - ( <b>Null Null</b> )		Die <b>grüne</b> LED blinkt weiterhin.
6. Drücken Sie einmal auf den Tastenknopf. 		Die durchgehend <b>grüne</b> LED zeigt an, dass die Timeout-Sperre deaktiviert wurde.

## 10. So finden Sie die DT2000 Versionsnummer

Anleitung	LED	LED-Status
1. Entsperren Sie den DT2000 mit Ihrer Benutzer-PIN.		Die <b>rote</b> durchgehend leuchtende LED wechselt auf <b>Grün</b> , wodurch angezeigt wird, dass die Eingabe der Benutzer-PIN erfolgreich war.
2. Drücken Sie zum Aufrufen der Optionen dreimal auf den Tastenknopf. (Dreifachklick) 		Die <b>grüne</b> und <b>blaue</b> LED blinken gleichzeitig und warten auf neue Anweisungen im OPTIONS-Modus.
3. Geben Sie innerhalb von 10 Sekunden die Zahl <b>8</b> (tu <b>v</b> ) gefolgt von der Zahl <b>6</b> (mno) ein - ( <b>86</b> )		<b>Grün</b> und <b>Blau</b> blinken gleichzeitig.
4. Drücken Sie einmal auf den Tastenknopf. 	 	Die LEDs <b>Rot</b> , <b>Grün</b> & <b>Blau</b> blinken gleichzeitig einmal auf, gefolgt vom Blinken der <b>roten</b> LED gemäß der ersten gültigen Ziffer der Revisionsnummer und danach blinkt die <b>grüne</b> LED gemäß der zweiten gültigen Ziffer der Revisionsnummer.
Für die Revisionsnummer 1.8 würden demzufolge die <b>rote</b> LED einmal (1) und die <b>grüne</b> LED achtmal (8) blinken. Wenn die Abfolge beendet ist, blinken die <b>rote</b> , <b>grüne</b> und <b>blaue</b> LED einmal gleichzeitig auf Und danach leuchtet die <b>grüne</b> LED durchgehend.		

## 11. Brute Force Hacker entdecken



**Achtung:** Wenn ein Benutzer zehnmal in Folge die inkorrekte Benutzer-PIN eingegeben hat, wird der Brute Force Mechanismus des DT2000 ausgelöst und die Benutzer-PIN, der Verschlüsselungs-Schlüssel **und alle gespeicherten Daten** werden gelöscht und sind für immer verloren.

Zum Entsperren des DT2000 verwendete PIN.	Was passiert nach 10 falschen PIN-Eingaben in Folge?
Benutzer-PIN	Der Brute Force Mechanismus des DT2000 wird ausgelöst und die Benutzer-PIN, der Verschlüsselungs-Schlüssel und alle gespeicherten Daten werden gelöscht und sind für immer verloren.

Wenn der Benutzer zehn Mal in Folge eine falsche PIN 10 eingegeben hat, werden der Verschlüsselungs-Schlüssel und alle gespeicherten Daten gelöscht und sind für immer verloren. Der DT2000 wird dann auf die werksseitige Benutzer-PIN (11223344) zurückgesetzt. Wie Sie die Benutzer-PIN ändern können, entnehmen Sie bitte Abschnitt 4 auf Seite 6. Da in diesem Rahmen auch ein neuer Verschlüsselungs-Schlüssel erstellt wird, muss der DT2000 neu formatiert werden (siehe Abschnitt 13 oder 14).

Im Gegensatz zu anderen, ähnlichen Laufwerken, ist im DT2000 ein Generator von Zufallszahlen integriert. Nachdem das Laufwerk zurückgesetzt wurde, wird ein neuer, zufälliger Schlüssel für die Verschlüsselung erstellt.

## 12. So setzen Sie den DT2000 zurück

Wenn Sie die Benutzer-PIN vergessen haben, oder alle auf dem DT2000 gespeicherten Daten löschen möchten, befolgen Sie bitte die nachstehend Anleitung.

Während des Zurücksetzens werden alle kryptographischen Parameter, einschließlich der Benutzer-PIN gelöscht. Dies bedeutet, dass der DT2000 auf die werksseitige Benutzer-PIN (11223344) zurückgesetzt wird. Wie Sie die Benutzer-PIN ändern können, entnehmen Sie bitte Abschnitt 4 auf Seite 6. Da in diesem Rahmen auch ein neuer Verschlüsselungs-Schlüssel erstellt wird, muss der DT2000 neu formatiert werden (siehe Abschnitt 13 oder 14).



**Achtung:** Beim Zurücksetzen des DT2000 werden **alle Daten** gelöscht, die auf dem Laufwerk gespeichert sind.

Anleitung	LED	LED-Status
1. Drücken Sie auf die Taste <b>7</b> (pqrs), und halten Sie sie gedrückt, und drücken Sie dann den Tastenknopf  . Lassen Sie die Tasten ( <b>7</b> &  ) los.	 / 	<b>Rot</b> und <b>Grün</b> blinken abwechselnd.
2. Geben Sie die Zahl <b>9</b> (wxyz) innerhalb von 10 Sekunden dreimal ein (Dreifachklick) ( <b>999</b> ).	 / 	<b>Rot</b> und <b>Grün</b> blinken abwechselnd.
3. Drücken Sie auf die Taste <b>7</b> (pqrs), und halten Sie sie gedrückt, drücken Sie dann den Tastenknopf  . Lassen Sie die Tasten ( <b>7</b> &  ) los.		Mit dem Erlöschen der <b>roten</b> LED wird angezeigt, dass das Zurücksetzen abgeschlossen ist.

## 13. So konfigurieren Sie den DT2000 unter dem Windows BS

Wenn eine Hacker-Entdeckung durch die aufeinanderfolgende **zehnmalige Eingabe einer falschen PIN** ausgelöst, oder das Laufwerk **zurückgesetzt** wird, **gehen alle auf dem Laufwerk gespeicherten Daten für immer verloren**.

Der DT2000 wird nach dem Erstellen einer neuen **Benutzer-PIN** neu eingerichtet und formatiert.

**Zum Einrichten Ihres DT2000 müssen Sie:**

1. Eine neue **Benutzer-PIN** erstellen (siehe Abschnitt 4).
2. Den DT2000 durch Eingabe der neuen **Benutzer-PIN** entsperren und in den USB-Anschluss eines Computers einstecken.
3. Der Computer muss dem Benutzer folgende Nachricht anzeigen:

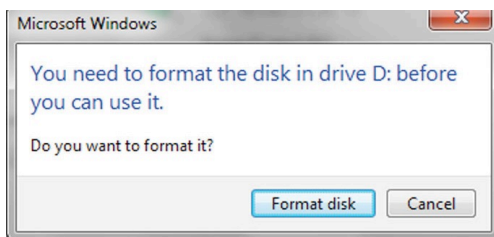

4. Fahren Sie durch Klicken auf **Format disk** fort. Wählen Sie je nach Bedarf **FAT32** oder **NTFS**, geben Sie eine **Datenträgerbezeichnung** ein und klicken Sie auf **Start**.

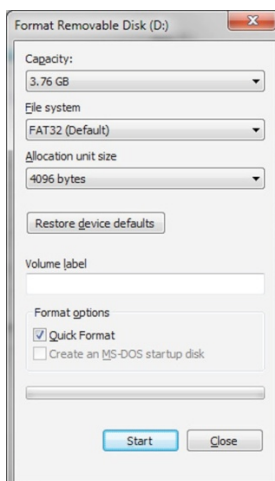

5. Klicken Sie zum Fortfahren der Laufwerksformatierung auf **OK**.



**Warnhinweis:** Durch dieses Verfahren werden **alle Daten** gelöscht, die auf diesem Laufwerk gespeichert sind.

6. Der Computer wird das Laufwerk formatieren und die Fertigstellung der Formatierung bestätigen. Während der Formatierung des DT2000 blinkt die **blaue** LED.

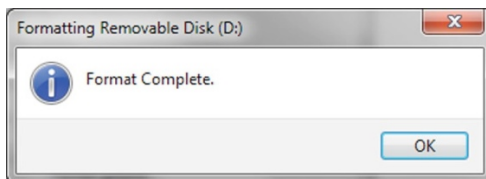

Nach Fertigstellung leuchtet die **blaue** LED durchgehend und Ihr DT2000 kann wieder verwendet werden.

**Wenn der Formatierungsassistent nicht angezeigt wird, verfahren Sie bitte folgendermaßen:**

1. Klicken Sie mit der rechten Maustaste auf **Mein Computer** oder **Computer** und danach auf **Verwalten**.
2. Der DT2000 wird im Fenster **Computerverwaltung** unter dem Tab **Datenträgerverwaltung** als Wechseldatenträger im RAW-Format angezeigt.

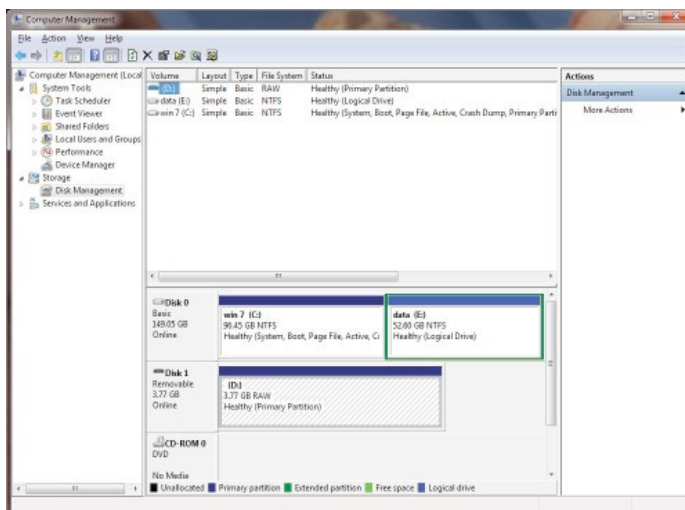



3. Klicken Sie mit der rechten Maustaste im freien Bereich unter dem nicht zugewiesenen Abschnitt auf **Raw-Wechseldatenträger** und wählen Sie **Formatieren** aus.

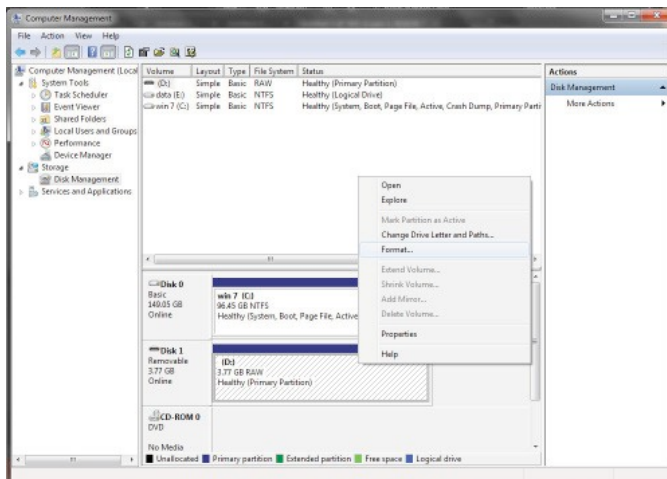

4. Das Fenster **Formatierung** wird geöffnet. Geben Sie eine neue **Datenträgerbezeichnung** ein. Wählen Sie je nach Bedarf **FAT32** oder **NTFS** aus und klicken Sie auf **OK**.

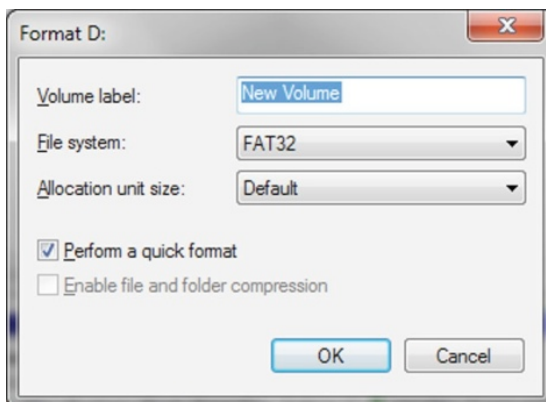

5. Klicken Sie auf **OK**, wenn das Warnfenster für die **Formatierung** angezeigt wird, um mit der Formatierung des Laufwerks fortzufahren.

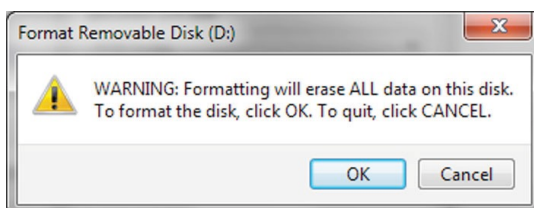

**Warnhinweis:** Durch dieses Verfahren werden **alle Daten** gelöscht, die auf diesem Laufwerk gespeichert sind.

6. Der Computer wird das Laufwerk formatieren und nach Fertigstellung zum Fenster **Datenträgerverwaltung** zurückkehren.

Während der Formatierung des DT2000 blinkt die **blaue** LED.

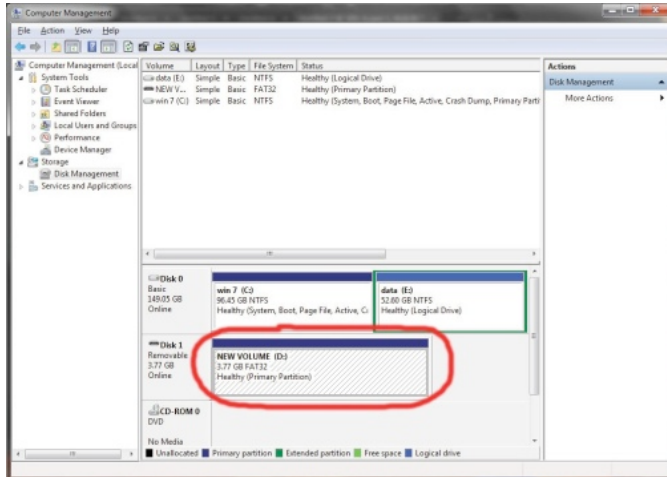

Nach Fertigstellung leuchtet die **blaue** LED durchgehend und Ihr DT2000 kann wieder verwendet werden.

## 14. So konfigurieren Sie den DT2000 unter dem Mac BS

Wenn eine Hacker-Entdeckung durch die aufeinanderfolgende zehnmahlige Eingabe einer falschen PIN ausgelöst, oder das Laufwerk zurückgesetzt wird, **gehen alle auf dem Laufwerk gespeicherten Daten für immer verloren.**

Der DT2000 wird nach dem Erstellen einer neuen **Benutzer-PIN** neu eingerichtet und formatiert.

Zum Formatieren Ihres DT2000 auf Computern mit dem Mac BS müssen Sie:

1. Eine neue **Benutzer-PIN** erstellen (siehe Abschnitt 4).
2. Den DT2000 durch Eingabe der neuen **Benutzer-PIN** entsperren und in den USB-Anschluss eines Mac Computers einstecken. Das System wird Sie mit dem Fenster **INITIALISIEREN** dazu auffordern.

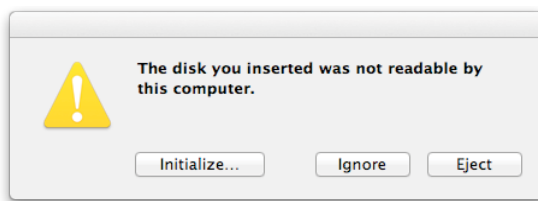

3. Drücken Sie auf **INITIALISIEREN** und wählen Sie den DT2000 im Fenster **Disk Utility** aus.

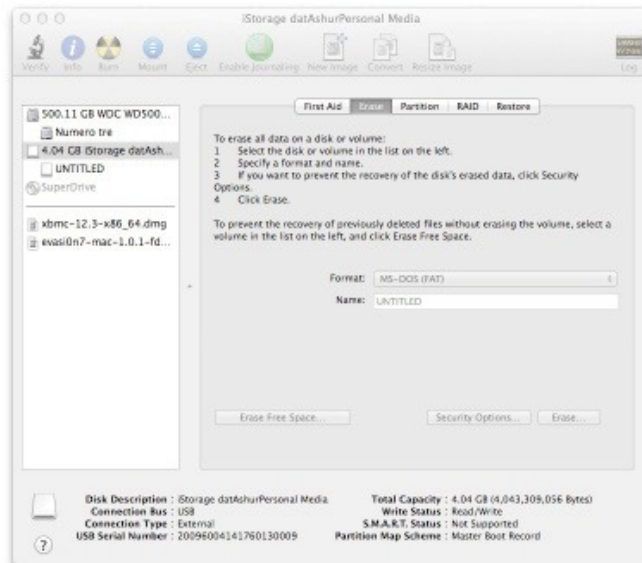

4. Klicken Sie links im Fenster **Disk Utility** auf den DT2000.
5. Wählen Sie **Löschen** aus dem Kontextmenü auf der rechten Seite des Fensters aus.  
Wählen Sie **MS-DOS** als **Format**.
6. Klicken Sie auf **Löschen**.

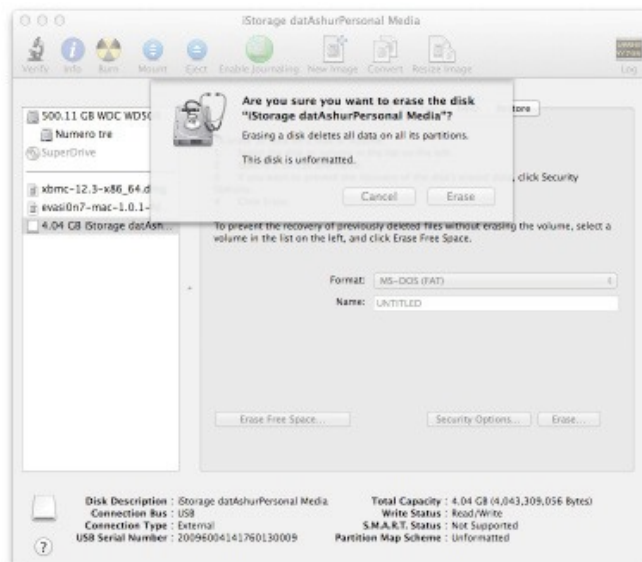

- Der formatierte DT2000 wird im Fenster **Disk Utility** angezeigt und auf den Desktop übernommen.

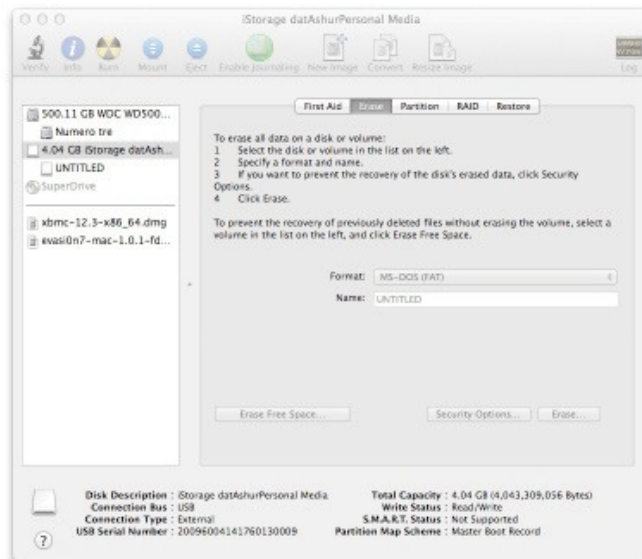

## Entsorgung von Akkus und Produkten

Elektronische und batteriebetriebene Produkte dürfen nicht mit dem normalen Haushaltsmüll entsorgt werden. Entsorgen Sie Ihre elektronischen Produkte bitte verantwortungsbewusst, damit ihre Auswirkungen auf die Umwelt so gering wie möglich gehalten werden können. Versuchen Sie nicht, den Akku aus dem Produkt auszubauen. Dies darf nur durch Kingston oder einen professionellen Dienstleister durchgeführt werden. Wenn Sie weitere Informationen über den Akku und die umweltgerechte Entsorgung des Produkts erhalten möchten, [kontaktieren Sie uns bitte](#).

DataTraveler® 2000 mit DataLock® Technologie unter Lizenz von ClevX, LLC.

## DataTraveler® 2000 - Manuel d'utilisation



**N'oubliez pas de garder votre code PIN dans un lieu sûr. Si vous le perdez ou l'oubliez, vous ne pourrez plus accéder aux données enregistrées sur votre Kingston DataTraveler®.**

**En cas de difficulté, veuillez consulter ce manuel d'utilisation complet de votre DT2000, qui est aussi disponible sur le site Kingston : [kingston.com/support](http://kingston.com/support)**

DataTraveler® 2000 intègre la technologie DataLock® sous licence ClevX, LLC.



## Table des Matières

Configuration système.....	3
Introduction.....	4
1. Agencement DT2000.....	5
2. Voyants LED et leur rôle .....	5
3. Première utilisation de la clé DT2000.....	6
4. Changement du code PIN utilisateur.....	6
5. Activation du mode Options.....	7
6. Activation du mode « Lecture seulement » .....	8
7. Activation du mode « Lecture/Écriture » .....	8
8. Activation du mode « Verrouillage temporisé » .....	9
9. Désactivation du mode « Verrouillage temporisé ».....	9
10. Identification de la version de votre DT2000 .....	10
11. Détection d'attaque Brute Force .....	10
12. Réinitialisation de la clé DT2000.....	11
13. Configuration de la clé DT2000 avec un système Windows .....	12
14. Configuration de la clé DT2000 avec un système Mac .....	15



## À propos de ce Manuel

Ce manuel d'utilisation est conçu pour la clé DataTraveler<sup>®</sup> 2000 Kingston (simplement appelée DT2000 dans ce document).

## Configuration système

---

### Plateforme PC

### Systèmes d'exploitation supportés

- Windows 10
  - Windows 8/8.1
  - Windows 7
  - Windows Vista<sup>®</sup> SP2
- 

### Plateforme Mac

### Prise en charge des systèmes d'exploitation

- Mac OS X 10.8.x - 10.11x
- 

### Plateforme Linux

### Prise en charge des systèmes d'exploitation

- Linux v2.6 kernel+
- 

### Autres plateformes

### Systèmes d'exploitation supportés

- Chrome OS<sup>™</sup>, Android\*
- 

\*Dispositifs compatibles uniquement. Vérifiez auprès de son fabricant si votre dispositif fonctionne avec les clés USB.

## Introduction



**Remarque** : La batterie rechargeable DT2000 fournie n'est pas totalement chargée. Nous recommandons de charger la batterie avant la première utilisation. Branchez la DT2000 sur un port USB sous tension pendant 60 minutes pour recharger totalement la batterie.

Nous vous remercions d'avoir choisi la DataTraveler® 2000, une clé USB 3.0 chiffrée, ultra-sécurisée et facile à utiliser, protégée par un code PIN.

La DT2000 utilise le chiffrement matériel XTS-AES 256 bits de classe militaire, qui chiffre en temps réel toutes les données qu'elle contient. La DT2000 ne nécessite aucun logiciel. Elle est indépendante du système d'exploitation et de l'équipement hôte.

La DT2000 est dotée d'une batterie rechargeable qui permet à l'utilisateur de saisir un code PIN de 7 à 15 chiffres (numéro d'identification personnel) sur son clavier intégré avant de l'insérer dans un port USB.

Si la clé est perdue ou volée, l'utilisateur a la certitude que toutes les données qu'elle contient resteront protégées et inaccessibles à toute personne non autorisée.

La DT2000 peut uniquement être déverrouillée par son clavier intégré et jamais par un ordinateur. Elle est invulnérable aux attaques logicielles ou matérielles par enregistreur de frappe ou brute force.



**Attention** : Le code PIN utilisateur par défaut de la DT2000 est  1-1-2-2-3-3-4-4 

Bien qu'elle puisse être immédiatement utilisée avec son code PIN par défaut, Kingston **recommande fortement, pour des raisons de sécurité, de le remplacer par un code PIN personnel** en suivant les instructions de la section 4 Changement du code PIN utilisateur.







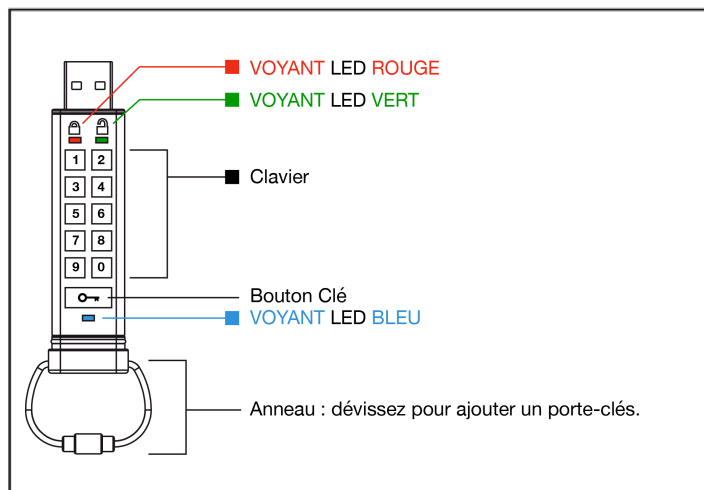







Si vous oubliez votre code PIN, vous ne pourrez pas accéder aux données qu'elle contient.

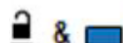

## 1. Agencement DT2000







## 2. Voyants LED et leur rôle

LED	État LED	Description	État LED	Description	Description
	<b>Rouge</b> Noir fondu 	Verrouillage / Code PIN incorrect		<b>Rouge</b> et <b>Vert</b> clignotant alternativement 	Réinitialisation d'usine
	<b>Rouge</b> clignotant 	Verrouillée et en attente du code PIN par défaut ou défini			
	<b>Vert</b> fixe 	La DT2000 est déverrouillée		Les voyants LED <b>Vert</b> et <b>Bleu</b> clignotent simultanément 	Mode « Option » utilisateur
	<b>Vert</b> clignotant 	Lorsque la clé est connectée à un port USB, le voyant LED <b>Vert</b> clignote toutes les deux secondes pour confirmer que la DT2000 est configurée en mode « Lecture uniquement ».			
	<b>Bleu</b> fixe 	Connectée sur un port USB			
	<b>Bleu</b> clignotant	Transfert de données avec code PIN utilisateur changeant / hôte			

### 3. Première utilisation de la clé DT2000

La DT2000 est fournie avec le code PIN par défaut 11223344. Bien qu'elle puisse être utilisée immédiatement avec ce code PIN par défaut, Kingston recommande fortement, pour des raisons de sécurité, de le remplacer par un code PIN personnel en suivant les instructions de la section 4 Changement du code PIN utilisateur.

Veuillez suivre les trois étapes simples présentées dans le tableau ci-dessous pour déverrouiller la DT2000 avec le code PIN par défaut.

Instructions (première utilisation)	LED	État LED
1. Appuyez une fois sur la touche CLÉ 		Les voyants LED <b>Rouge</b> , <b>Vert</b> & <b>Bleu</b> clignotent simultanément une fois. Ensuite, le voyant LED <b>Rouge</b> continue de clignoter.
2. Commencez à saisir le code PIN utilisateur avant l'expiration du délai de dix secondes (par défaut : 11223344) pour déverrouiller la DT2000		Le voyant LED <b>Rouge</b> continue de clignoter
3. Appuyez une fois sur la touche CLÉ 		Le voyant LED <b>Rouge</b> est fixe, puis devient <b>Vert</b> fixe, pour confirmer la saisie du code PIN utilisateur correct



**Remarque** : Lorsque la DT2000 est déverrouillée, le voyant LED **Vert** reste fixe pendant seulement 30 secondes, et la DT2000 doit être connectée à un port USB pendant cette durée. La clé peut être immédiatement verrouillée en maintenant la touche CLÉ enfoncée  pendant trois secondes, ou en attendant l'expiration du délai de 30 secondes, ou en cliquant sur l'icône « Retirer le matériel en toute sécurité » de votre système d'exploitation.

### 4. Changement du code PIN utilisateur

Conditions d'utilisation du code PIN :













- Le code doit contenir de 7 à 15 chiffres
- Il ne doit pas contenir uniquement des chiffres répétés, ex. : (3-3-3-3-3-3)
- Il ne doit pas contenir uniquement des chiffres consécutifs, ex. : (1-2-3-4-5-6-7), (7-8-9-0-1-2-3-4), (7-6-5-4-3-2-1)

**Conseil de sélection du mot de passe** : Vous pouvez créer un mot, nom, phrase ou une combinaison de caractères alphanumériques, qui sera votre mot de passe, simplement en appuyant sur les touches des caractères choisis.

Exemples de ces types de codes PIN alphanumériques :

- Si votre code PIN est « **password** », vous appuyez sur les touches suivantes :  
7 (pqrs) 2 (abc) 7 (pqrs) 7 (pqrs) 9 (wxyz) 6 (mno) 7 (pqrs) 3 (def)
- Si votre code PIN est « **kingston** », vous appuyez sur :  
5 (jkl) 4 (ghi) 6 (mno) 4 (ghi) 7 (pqrs) 8 (tuv) 6 (mno) 6 (mno)

Grâce à cette méthode, vous pouvez créer des codes PIN longs et faciles à mémoriser.

Instructions	LED	État LED
1. Appuyez une fois sur la touche CLÉ 		Les voyants LED <b>Rouge</b> , <b>Vert</b> & <b>Bleu</b> clignotent simultanément une fois. Ensuite, le voyant LED <b>Rouge</b> continue de clignoter
2. Commencez à saisir le code PIN utilisateur avant l'expiration du délai de dix secondes (par défaut : 11223344) pour déverrouiller la DT2000		Le voyant LED <b>Rouge</b> continue de clignoter
3. Appuyez une fois sur la touche CLÉ 		Le voyant LED <b>Rouge</b> est fixe, puis devient <b>Vert</b> fixe, pour confirmer la saisie du code PIN utilisateur correct
4. Appuyez deux fois sur la touche CLÉ (double-clic) 		Le voyant LED <b>Bleu</b> clignote
5. Commencez à saisir le nouveau code PIN utilisateur avant l'expiration du délai de dix secondes		Le voyant LED <b>Bleu</b> continue de clignoter
6. Appuyez deux fois sur la touche CLÉ (double-clic) 		Le voyant LED <b>Vert</b> clignote
7. Commencez à saisir une deuxième fois le nouveau code PIN utilisateur avant l'expiration du délai de dix secondes		Le voyant LED <b>Vert</b> continue de clignoter
8. Appuyez deux fois sur la touche CLÉ (double-clic) 		Le voyant LED <b>Rouge</b> est fixe, puis devient <b>Vert</b> fixe, pour confirmer la saisie du code PIN utilisateur correct









**Remarque** : Si la saisie du nouveau code PIN contient une erreur ou si la procédure n'est pas correctement terminée, la clé continuera d'utiliser le code PIN précédent.

## 5. Activation du mode Options



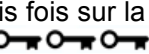



Le mode « Options » permet d'utiliser différentes fonctions, incluant l'activation ou la désactivation de la clé DT2000 en mode « Lecture seulement », la configuration automatique de la temporisation, l'accès à la version de la clé.

Le tableau ci-dessous explique comment accéder au mode « Options ». Les sections 6 - 9 décrivent comment utiliser les diverses fonctions.

Instructions	LED	État LED
1. Appuyez une fois sur la touche CLÉ 		Les voyants LED <b>Rouge</b> , <b>Vert</b> et <b>Bleu</b> clignotent simultanément une fois. Ensuite, le voyant LED <b>Rouge</b> continue de clignoter.
2. Commencez à saisir le nouveau code PIN utilisateur avant l'expiration du délai de dix secondes (par défaut : 11223344) pour déverrouiller la DT2000		Le voyant LED <b>Rouge</b> continue de clignoter
3. Appuyez une fois sur la touche CLÉ 		Le voyant LED <b>Rouge</b> est fixe, puis devient <b>Vert</b> fixe, pour confirmer la saisie du code PIN utilisateur correct
4. Appuyez trois fois sur la touche CLÉ (triple-clic) 		Les voyants LED <b>Vert</b> et <b>Bleu</b> clignotent simultanément en attente de nouvelles instructions en mode « Options ».

## 6. Activation du mode « Lecture seulement »

Le mode « Lecture seulement » de la DT2000 sert à restreindre l'accès à son contenu. Ce mode est activé en suivant les instructions ci-dessous :

Instructions	LED	État LED
1. Déverrouillez la DT2000 avec le code PIN		Le voyant LED <b>Rouge</b> est fixe, puis devient <b>Vert</b> fixe, pour confirmer la saisie du code PIN utilisateur correct
2. Activez le mode Options en appuyant trois fois sur la touche CLÉ (triple-clic) 		Les voyants LED <b>Vert</b> et <b>Bleu</b> clignotent simultanément en attente de nouvelles instructions en mode « Options ».
3. Saisissez le chiffre 7 avant l'expiration du délai de dix secondes, ( <b>pqrs</b> ) puis le chiffre 6, touche ( <b>mno</b> ) - (76)		Les voyants LED <b>Vert</b> et <b>Bleu</b> continuent de clignoter simultanément.
4. Appuyez une fois sur la touche CLÉ 		Le voyant LED <b>Bleu</b> devient rapidement <b>Vert</b> fixe, lorsque la DT2000 est insérée dans un port USB. Le voyant LED <b>Vert</b> clignote toutes les deux secondes indiquant que la clé est en mode « Lecture seulement ».







Une fois ce mode activé, l'accès aux données est limité à la seule lecture, jusqu'à ce que l'interdiction d'écriture soit désactivée.



**Remarque** : Nous avons intégré une convention de nommage pour aider l'utilisateur à mémoriser la saisie de chaque configuration optionnelle. Dans le tableau ci-dessus, les chiffres représentent les premiers caractères de nom de la fonction optionnelle. Par exemple, **Read-Only** = 7 (**pqrs**) 6 (**mno**).

## 7. Activation du mode « Lecture / Écriture »

La protection en écriture (Lecture uniquement) peut être désactivée pour rétablir le mode Lecture / Écriture. Pour cela, suivez les instructions ci-dessous :

Instructions	LED	État LED
1. Déverrouillez la DT2000 avec le code PIN		Le voyant LED <b>Rouge</b> est fixe, puis devient <b>Vert</b> fixe, pour confirmer la saisie du code PIN utilisateur correct
2. Activez le mode Options en appuyant trois fois sur la touche CLÉ (triple-clic) 		Les voyants LED <b>Vert</b> et <b>Bleu</b> clignotent simultanément en attente de nouvelles instructions en mode « Options ».
3. Avant l'expiration du délai de dix secondes, saisissez le chiffre 7 ( <b>pqrs</b> ), puis le chiffre 9, touche ( <b>wxyz</b> ) - (79)		Les voyants LED <b>Vert</b> et <b>Bleu</b> continuent de clignoter simultanément.
4. Appuyez une fois sur la touche CLÉ 		Le voyant LED <b>Bleu</b> devient rapidement <b>Vert</b> fixe, lorsque la DT2000 est insérée dans un port USB. Le voyant LED <b>Vert</b> clignote toutes les deux secondes indiquant que la clé est en mode Lecture / Écriture.















Une fois ce mode activé, l'accès aux données est rétabli avec le mode Lecture / Écriture par défaut.

## 8. Activation du mode « Verrouillage temporisé »

Pour interdire les accès non autorisés lorsque la DT2000 est connectée à un système hôte et laissée sans surveillance, la DT2000 peut être configurée pour se verrouiller automatiquement après une durée prédéfinie.















Dans l'état par défaut, le mode « Verrouillage temporisé » de la DT2000 est désactivé. Le mode « Verrouillage temporisé » peut être configuré pour s'activer (verrouiller) automatiquement entre 1 et 99 minutes.

Pour configurer le mode « Verrouillage temporisé », veuillez suivre les instructions dans le tableau ci-dessous.







Instructions	LED	État LED
1. Déverrouillez la DT2000 avec le code PIN	 → 	Le voyant LED <b>Rouge</b> est fixe, puis devient <b>Vert</b> fixe, pour confirmer la saisie du code PIN utilisateur correct.
2. Activez le mode Options en appuyant trois fois sur la touche CLÉ (triple-clic)   	 & 	Les voyants LED <b>Vert</b> et <b>Bleu</b> clignotent simultanément en attente de nouvelles instructions en mode « Options ».
3. Avant l'expiration du délai de dix secondes, saisissez le chiffre <b>8</b> ( <b>tuv</b> ), puis le chiffre <b>5</b> , touche ( <b>jkl</b> ) - ( <b>85</b> )	 & 	Les voyants LED <b>Vert</b> et <b>Bleu</b> continuent de clignoter simultanément.
4. Appuyez une fois sur la touche CLÉ 		Le voyant LED <b>Green</b> clignote.
5. Avant l'expiration du délai de dix secondes, saisissez la durée de la temporisation en deux chiffres : 00 = 0 minutes (par défaut) 01 = 1 minute 99 = 99 minutes, etc..		Le voyant LED <b>Vert</b> continue de clignoter.
6. Appuyez une fois sur la touche CLÉ 		Le voyant LED <b>Vert</b> est fixe, confirmant que le mode « Verrouillage temporisé » est activé.

## 9. Désactivation du mode « Verrouillage temporisé »

Pour désactiver le mode « Verrouillage temporisé », veuillez suivre les instructions dans le tableau ci-dessous.

Instructions	LED	État LED
1. Déverrouillez la DT2000 avec le code PIN	 → 	Le voyant LED <b>Rouge</b> est fixe, puis devient <b>Vert</b> fixe, pour confirmer la saisie du code PIN utilisateur correct.
2. Activez le mode Options en appuyant trois fois sur la touche CLÉ (triple-clic)   	 & 	Les voyants LED <b>Vert</b> et <b>Bleu</b> clignotent simultanément en attente de nouvelles instructions en mode « Options ».
3. Avant l'expiration du délai de dix secondes, saisissez le chiffre <b>8</b> ( <b>tuv</b> ) puis le chiffre <b>5</b> , touche ( <b>jkl</b> ) - ( <b>85</b> )	 & 	Les voyants LED <b>Vert</b> et <b>Bleu</b> continuent de clignoter simultanément.
4. Appuyez une fois sur la touche CLÉ 		Le voyant LED <b>Vert</b> clignote.
5. Avant l'expiration du délai de dix secondes, saisissez le chiffre <b>0</b> deux fois (double-clic) ( <b>zéro zéro</b> ) - ( <b>00</b> )		Le voyant LED <b>Vert</b> continue de clignoter.
6. Appuyez une fois sur la touche CLÉ 		Le voyant LED <b>Vert</b> est fixe, confirmant que le mode « Verrouillage temporisé » est désactivé.

## 10. Identification de la version de votre DT2000

Instructions	LED	État LED
1. Déverrouillez la DT2000 avec le code PIN		Le voyant LED <b>Rouge</b> est fixe, puis devient <b>Vert</b> fixe, pour confirmer la saisie du code PIN utilisateur correct
2. Activez le mode Options en appuyant trois fois sur la touche CLÉ (triple-clic) 		Les voyants LED <b>Vert</b> et <b>Bleu</b> clignotent simultanément en attente de nouvelles instructions en mode « Options ».
3. Avant l'expiration du délai de dix secondes, saisissez le chiffre <b>8</b> (tuv), puis le chiffre <b>6</b> , touche (mno) - ( <b>86</b> )		Les voyants LED <b>Vert</b> et <b>Bleu</b> continuent de clignoter simultanément.
4. Appuyez une fois sur la touche CLÉ 	 	Les voyants LED <b>Rouge</b> , <b>Vert</b> & <b>Bleu</b> clignotent rapidement et simultanément une fois. Puis le voyant LED <b>Rouge</b> clignote sur le premier chiffre de la version, puis le voyant LED <b>Vert</b> clignote sur le deuxième chiffre de la version.
Par exemple, si la version est « 1.8 », le voyant LED <b>Rouge</b> clignote une (1) fois et le voyant LED <b>Vert</b> clignote huit (8) fois. Lorsque la séquence est terminée, les voyants LED <b>Rouge</b> , <b>Vert</b> et <b>Bleu</b> clignotent une fois simultanément, puis le voyant LED <b>Vert</b> reste allumé.		

## 11. Détection d'attaque Brute Force



**Attention** : Si un code PIN erroné est saisi dix (10) fois, le mécanisme de protection de la DT2000 contre les attaques se déclenche. Le code PIN, la clé de chiffrement, **et toutes les données** sont alors irrémédiablement supprimés.

Le code PIN utilisé pour déverrouiller la DT2000	Que se passe t-il après dix tentatives d'accès avec un code PIN erroné ?
Code PIN utilisateur	Le mécanisme de protection de la DT2000 contre les attaques se déclenche et le code PIN, la clé de chiffrement et toutes les données sont irrémédiablement supprimées.

Si l'utilisateur saisit dix fois un code PIN erroné, le code PIN, la clé de chiffrement, et toutes les données sont irrémédiablement supprimées. La DT2000 rétablit automatiquement le code PIN par défaut (11223344). Voir la Section 4 Changement du code PIN utilisateur, à la page 6. En outre, comme ce mécanisme force la création d'une nouvelle clé de chiffrement, la DT2000 devra être reformatée (voir Section 13 ou 14).

Comme d'autres clés USB, la DT2000 est dotée d'un générateur de chiffres aléatoires. Lorsque la clé est réinitialisée, une nouvelle clé de chiffrement est générée aléatoirement.









## 12. Réinitialisation de la clé DT2000

Si le code PIN est perdu, ou si l'utilisateur souhaite supprimer toutes les données enregistrées sur la DT2000, veuillez suivre les instructions ci-dessous.

Le processus de réinitialisation efface tous les paramètres cryptographiques, incluant le code PIN. Par conséquent, la DT2000 rétablira automatiquement le code PIN par défaut (11223344). Voir la Section 4 Changement du code PIN utilisateur, page 6. En outre, comme ce processus force la création d'une nouvelle clé de chiffrement, la DT2000 devra être reformatée (voir Section 13 ou 14).



**Attention** : La réinitialisation de la DT2000 supprime définitivement toutes les données au'elle contient.

Instructions	LED	État LED
1. Appuyez et maintenez la touche <b>7</b> , touche (pqrs), puis appuyez sur la touche  CLÉ. Relâchez les touches ( <b>7</b> et  )	 / 	Les voyants LED <b>Rouge</b> et <b>Vert</b> clignotent alternativement
2. Avant l'expiration du délai de dix secondes, saisissez trois fois le chiffre <b>9</b> , touche (wxyz) (triple-clic) ( <b>999</b> )	 / 	Les voyants LED <b>Rouge</b> et <b>Vert</b> clignotent alternativement
3. Appuyez et maintenez la touche <b>7</b> , touche (pqrs), puis appuyez sur la touche  CLÉ. Relâchez les touches ( <b>7</b> et  )		Le voyant LED <b>Rouge</b> s'éteint progressivement à la fin de la réinitialisation.

## 13. Configuration de la clé DT2000 avec un système Windows

Après **dix tentatives successives de saisie erronées du code PIN**, ou si la clé a été réinitialisée, **toutes les données qu'elle contient sont définitivement effacées et perdues**.

Après la création d'un **nouveau code PIN**, la DT2000 doit être réinitialisée et formatée.

**Pour réinitialiser votre DT2000, suivez les instructions ci-dessous :**

1. Créez un nouveau **code PIN utilisateur** (voir Section 4).
2. Déverrouillez la clé DT2000 en saisissant le nouveau **code PIN utilisateur** et insérez la clé dans un port USB d'un ordinateur.
3. L'ordinateur notifiera l'utilisateur en affichant le message suivant :

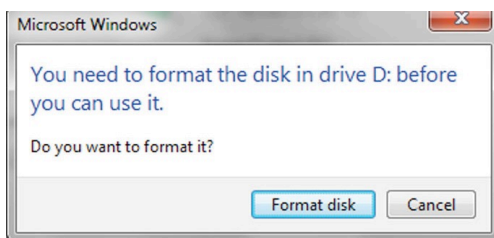

4. Continuez en cliquant sur **Formater le disque**. Sélectionnez **FAT32** ou **NTFS**, selon vos besoins, et saisissez un **Label du volume** et cliquez sur **Démarrer**.

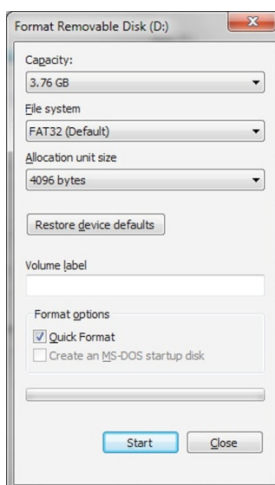



5. Cliquez sur **OK** pour confirmer le formatage de la clé.



**Avertissement** : Cette procédure effacera **toutes les données** enregistrées sur la clé.

6. L'ordinateur continuera le formatage de la clé et signalera la fin de l'opération réussie. Pendant le formatage de la DT2000, le voyant LED **Bleu** clignote.

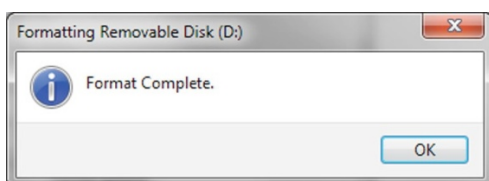

Lorsque le formatage est terminé, le voyant LED **Bleu** devient fixe, signalant que votre DT2000 est prête à être utilisée.

**Si l'assistant de formatage ne s'affiche pas automatiquement, veuillez suivre la procédure ci-dessous :**

1. Cliquez avec le bouton droit de la souris sur **Mon poste de travail** ou **Ordinateur** et cliquez sur **Gérer**.
2. Dans la fenêtre **Gestion de l'ordinateur**, la DT2000 est affichée comme dispositif amovible au format brut dans la section **Gestion des disques**.

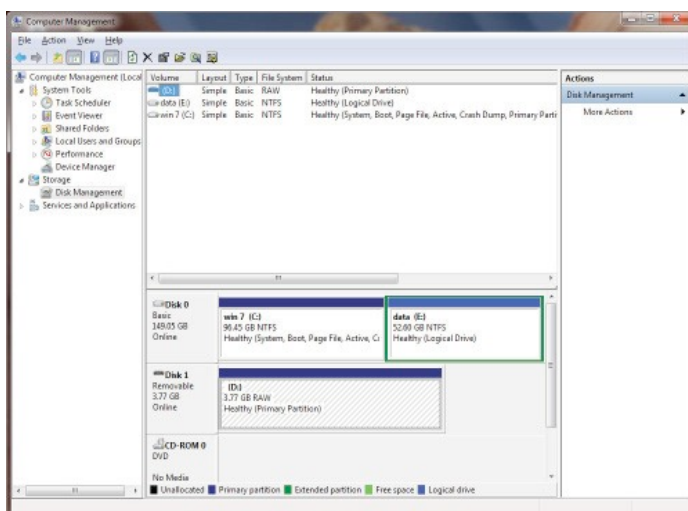

3. Dans la zone vide sous la section non attribuée, cliquez avec le bouton droit de la souris sur **Disque brut amovible** et sélectionnez **Formater**.

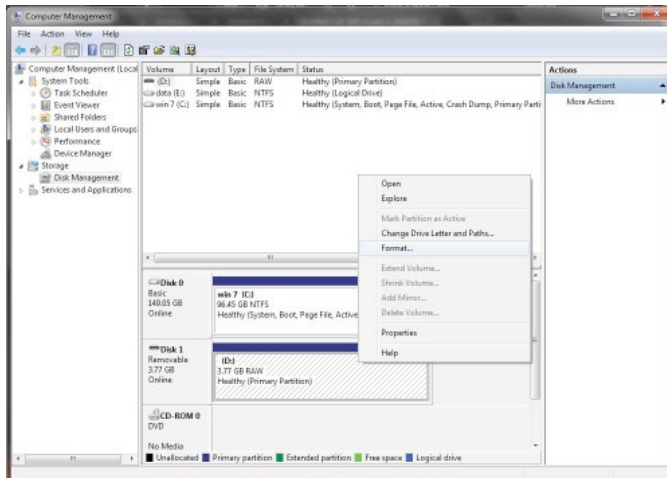

4. La fenêtre **Formatage** s'ouvre.  
Saisissez un nouveau **Label de volume**.  
Sélectionnez **FAT32** ou **NTFS** selon vos besoins, et cliquez sur **OK**.

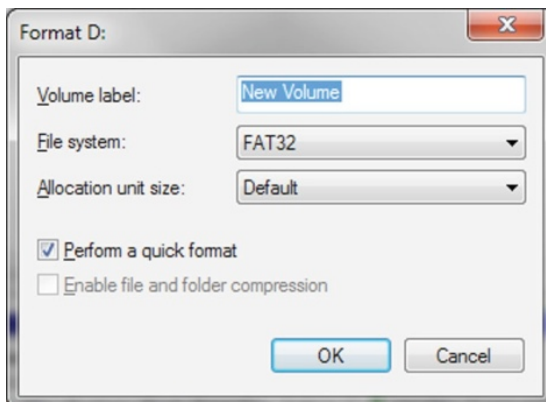

5. Cliquez sur **OK** dans la fenêtre d'avertissement **Formater** pour confirmer le formatage de la clé.

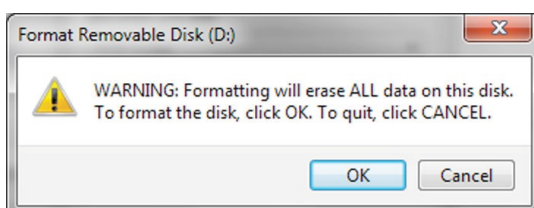

**Avertissement** : Cette procédure efface **toutes les données** enregistrées sur la clé.

6. L'ordinateur termine le formatage et affiche la fenêtre **Gestion des disques**.

Pendant le formatage de la DT2000, le voyant LED **Bleu** clignote.

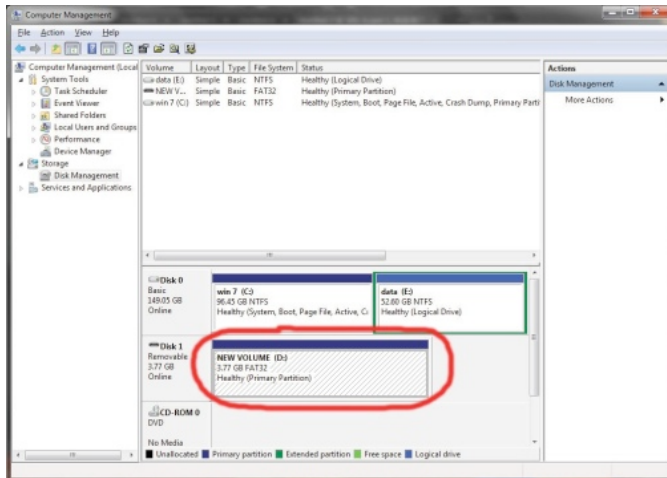

Lorsque le formatage est terminé, le voyant LED **Bleu** devient fixe, signalant que votre DT2000 est prête à être utilisée.

## 14. Configuration de la clé DT2000 avec un système Mac

Après dix tentatives successives de saisie erronées du code PIN, ou si la clé a été réinitialisée, **toutes les données qu'elle contient sont définitivement effacées et perdues.**

Après la création d'un **nouveau code PIN**, la DT2000 doit être réinitialisée et formatée.

Pour formater la DT2000 avec un ordinateur Mac OS, suivez les instructions ci-dessous.

1. Créez un nouveau **code PIN utilisateur** (voir Section 4).
2. Déverrouillez la clé DT2000 en saisissant le nouveau **code PIN utilisateur** et insérez la clé dans un port USB d'un ordinateur Mac. Le système affichera une fenêtre **INITIALISER**.

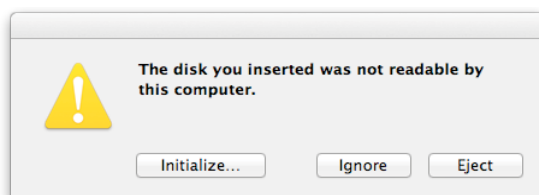

3. Cliquez sur **INITIALISER** et sélectionnez la DT2000 dans la fenêtre **Utilitaire de disque**.

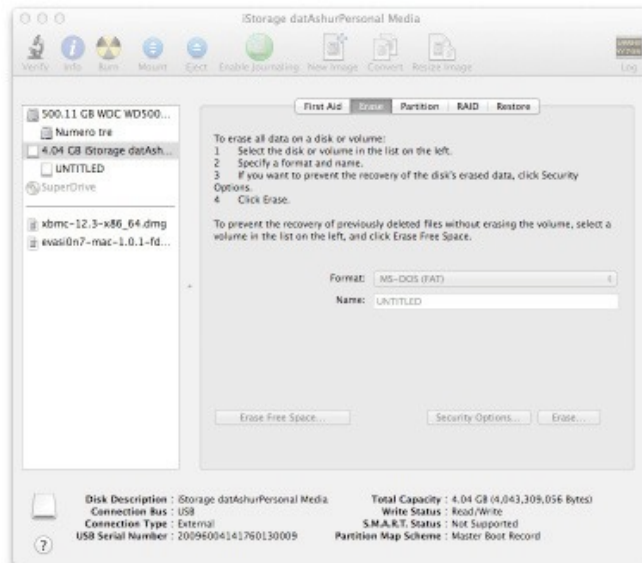

4. Cliquez sur la DT2000 affichée sur la gauche dans la fenêtre **Utilitaire de disque**.
5. Choisissez **Effacer**, dans le menu contextuel, sur la droite de la fenêtre. Sélectionnez **MS-DOS** dans **Format du volume**.
6. Cliquez sur **Effacer**.

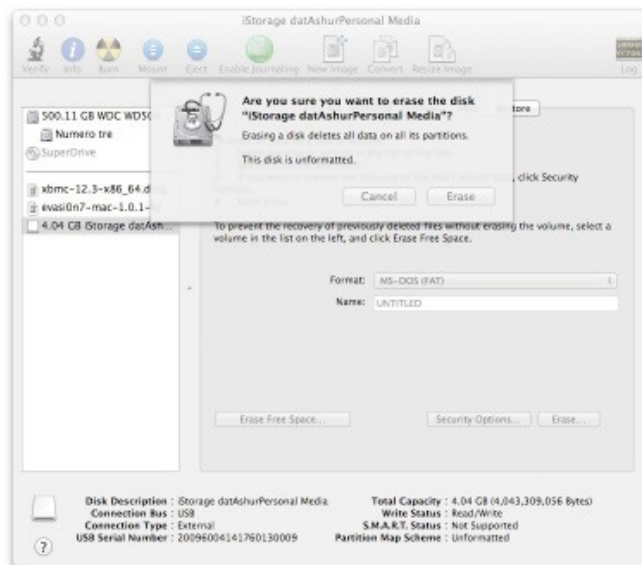

7. La DT2000 formatée est affichée dans la fenêtre **Utilitaire de disque** et montée sur le bureau.

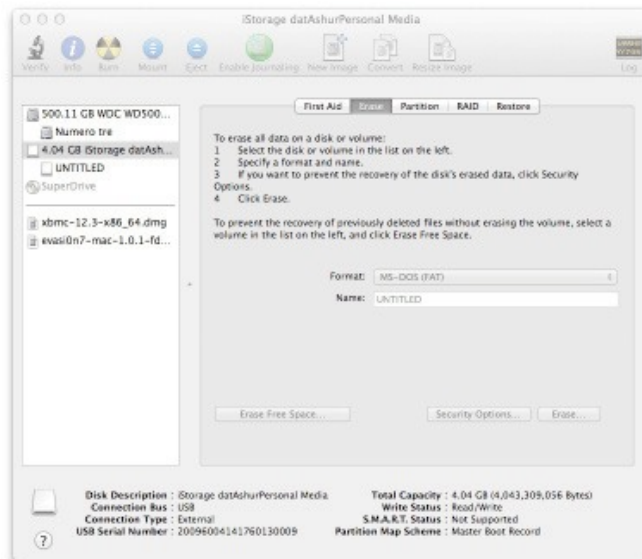

## Informations sur la batterie / mise au rebut des produits électriques

Veuillez ne pas mettre au rebut de déchets électriques ou contenant une batterie dans les ordures ménagères. Les produits électroniques doivent être mis au rebut de manière responsable pour protéger l'environnement. Veuillez ne pas essayer de retirer la batterie du produit. Elle peut uniquement être démontée par Kingston ou un service professionnel. Veuillez nous [contacter](#) pour obtenir d'autres informations et pour recycler des produits de manière responsable.

DataTraveler® 2000 intègre la technologie DataLock® sous licence ClevX, LLC.

## DataTraveler® 2000 - Manuale d'uso



**ATTENZIONE - Conservare il PIN in un luogo sicuro. Qualora fosse perso o dimenticato, non sarà più possibile accedere in alcun modo ai dati archiviati nel drive Kingston DataTraveler®.**

**In caso di difficoltà, è possibile consultare il presente manuale utente memorizzato nell'unità DT2000, disponibile anche sul sito web di Kingston all'indirizzo:**  
[kingston.com/support](http://kingston.com/support)

DataTraveler® 2000 incorpora la tecnologia DataLock® su licenza di ClevX, LLC.

©2016 Kingston Technology Corporation, 17600 Newhope Street, Fountain Valley, CA 92708 USA. Tutti i diritti riservati. Tutti i marchi e i marchi registrati sono di proprietà dei rispettivi titolari.

## Indice dei contenuti

Requisiti di sistema.....	3
Introduzione.....	4
1. Panoramica sull'unità DT2000 .....	5
2. Indicatori LED e rispettive funzioni.....	5
3. Primo utilizzo dell'unità DT2000 .....	6
4. Come modificare il PIN utente .....	6
5. Come attivare le opzioni.....	7
6. Come attivare la modalità Read-Only .....	8
7. Come attivare la modalità Read / Write .....	8
8. Come attivare la modalità Timeout Lock.....	9
9. Come disattivare la modalità Timeout Lock .....	9
10. Come individuare il numero di versione dell'unità DT2000.....	10
11. Come rilevare un'intrusione di tipo Brute Force .....	10
12. Come riportare l'unità DT2000 alle impostazioni di fabbrica.....	11
13. Come configurare l'unità DT2000 con un sistema operativo Windows.....	12
14. Come configurare l'unità DT2000 con un sistema operativo Mac.....	15

## ***Informazioni sulla presente Guida***

Questo manuale d'uso contiene le istruzioni per l'uso dell'unità DataTraveler® 2000 di Kingston (di seguito con l'abbreviazione DT2000).

## **Requisiti di sistema**

---

### **Piattaforma PC**

#### **Sistemi operativi supportati**

- Windows 10
  - Windows 8/8.1
  - Windows 7
  - Windows Vista® SP2
- 

### **Piattaforma Mac**

#### **Sistemi operativi supportati**

- Mac OS X 10.8.x - 10.11x
- 

### **Piattaforma Linux**

#### **Sistemi operativi supportati**

- Linux v2.6 kernel+
- 

### **Altre piattaforme**

#### **Sistemi operativi supportati**

- Chrome OS™, Android\*
- 

\*Solo dispositivi compatibili. Rivolgersi al produttore del dispositivo per accertarsi che il dispositivo supporti i drive Flash USB.



## Introduzione



**Nota:** appena estratta dalla confezione, la batteria ricaricabile dell'unità DT2000 non è completamente carica. Prima di iniziare a utilizzare l'unità, si consiglia di ricaricare la batteria. Per una ricarica completa, è sufficiente collegare l'unità DT2000 a una porta USB alimentata per 60 minuti.

Grazie per aver acquistato l'unità DataTraveler® 2000, un drive Flash USB 3.0 con attivazione PIN e crittografia hardware, ultra-sicuro ed estremamente facile da utilizzare.



L'unità DT2000 offre una crittografia hardware XTS-AES 256-bit di livello militare, capace di crittografare in tempo reale qualsiasi dato venga archiviato nell'unità. L'unità non necessita di alcun software e non è vincolata all'impiego di un specifico SO o dispositivo a cui essere collegata.

L'unità DT2000 incorpora una batteria ricaricabile che consente all'utente di immettere sul tastierino numerico un codice PIN (Personal Identification Number) composto da 7 a 15 cifre, prima di connettere il drive a una porta USB.

In caso di smarrimento o furto dell'unità, l'utente ha la certezza che i dati archiviati all'interno dell'unità DT2000 sono al sicuro e nessuno potrà mai accedervi.

L'unità DT2000 può essere sbloccata solo tramite il proprio tastierino e non attraverso il computer cui viene collegata. Ne consegue che è completamente invulnerabile in caso di attacchi di tipo "key-loggers" software/hardware o attacchi cd. "brute force".



**Attenzione:** l'unità DT2000 lascia la fabbrica con il PIN utente 1-1-2-2-3-3-4-4  preimpostato e, sebbene sia possibile iniziare a utilizzarla subito con il PIN predefinito, per ragioni di sicurezza **è fortemente consigliabile impostare subito un nuovo codice PIN utente:** a questo scopo, è sufficiente seguire le istruzioni riportate nella sezione 4, "Come modificare il PIN utente".

In caso di perdita del codice PIN, tutti i dati presenti nell'unità diverranno inaccessibili.

## 1. Panoramica sull'unità DT2000

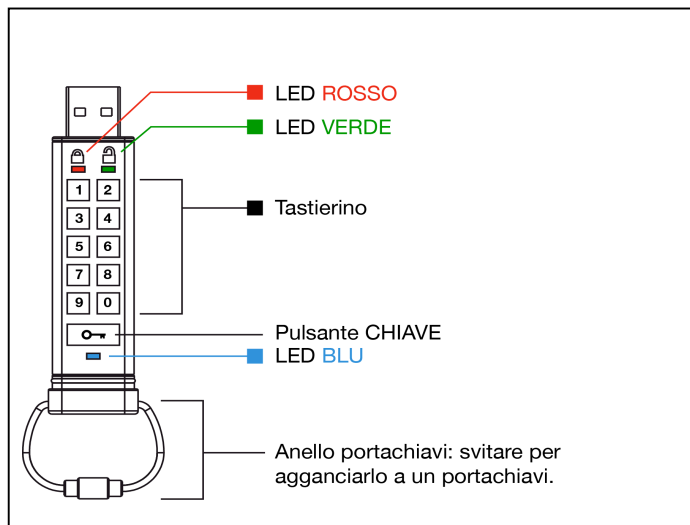





## 2. Indicatori LED e rispettive funzioni

LED	Stato LED	Descrizione	Stato LED	Descrizione	Descrizione
	<b>Rosso Nero sfumato</b> 	Bloccaggio in corso/Immissione PIN errato		<b>Rosso e Verde</b> in lampeggio alternato 	Ripristino opzioni di fabbrica
	<b>Rosso lampeggiante</b> 	Bloccato e in attesa del PIN predefinito in fabbrica o del PIN modificato dall'utente			
	<b>Verde fisso</b> 	L'unità DT2000 è sbloccata		<b>Verde e Blu</b> in lampeggio simultaneo 	Modalità Opzioni utente
	<b>Verde lampeggiante</b> 	Quando è connessa a una porta USB, se il LED <b>Verde</b> lampeggia a intervalli di 2 secondi, l'unità DT2000 risulta impostata in modalità "Read-Only"			
	<b>Blu fisso</b> 	Connessa a una porta USB			
	<b>Blu lampeggiante</b> 	Scambio dati con dispositivo host/modifica in corso PIN utente			

### 3. Primo utilizzo dell'unità DT2000

L'unità DT2000 lascia la fabbrica con il PIN utente 11223344 preimpostato e, sebbene sia possibile iniziare a utilizzarla subito con il PIN preimpostato, per ragioni di sicurezza è fortemente consigliabile impostare subito un nuovo codice PIN utente: a questo scopo, è sufficiente seguire le istruzioni riportate nella sezione 4, "Come modificare il PIN utente".

Per iniziare a utilizzare subito l'unità DT2000, immettendo il PIN preimpostato in fabbrica, è sufficiente effettuare le 3 semplici operazioni riportate nella tabella seguente:

Istruzioni (per il primo utilizzo)	LED	Stato LED
1. Premere il pulsante CHIAVE una sola volta 		I LED <b>Rosso</b> , <b>Verde</b> e <b>Blu</b> si accenderanno insieme per una volta, quindi continuerà a lampeggiare il solo LED <b>Rosso</b>
2. Entro 10 secondi, immettere il PIN utente (preimpostato - 11223344) per sbloccare l'unità DT2000		Il LED <b>Rosso</b> continuerà a lampeggiare
3. Premere il pulsante CHIAVE una sola volta 		Si accenderà un LED fisso che cambierà colore da <b>Rosso</b> a <b>Verde</b> : ciò indica il corretto inserimento del PIN utente preimpostato in fabbrica.



**Nota:** Una volta sbloccata, l'unità DT2000 può essere connessa ad una porta USB entro i successivi 30 secondi, durante i quali il LED **Verde** resterà acceso con luce fissa. Se lo si desidera, è possibile bloccare immediatamente l'unità tenendo premuto il pulsante CHIAVE  per 3 secondi; in alternativa è possibile lasciar trascorrere i 30 secondi o fare clic sull'icona "Rimozione sicura dell'hardware ed espulsione supporti" del sistema operativo.

### 4. Come modificare il PIN utente

Caratteristiche del PIN:

- Lunghezza compresa tra 7 e 15 cifre
- Non può contenere solo numeri ripetuti, es. (3-3-3-3-3-3)
- Non può contenere solo numeri consecutivi, es. (1-2-3-4-5-6-7), (7-8-9-0-1-2-3-4), (7-6-5-4-3-2-1)

**Suggerimento password:** sfruttando le lettere presenti sui tasti, è possibile creare PIN facili da ricordare perché associati a parole, nomi, frasi o altre combinazioni alfanumeriche.

Ecco alcuni esempi di questi PIN alfanumerici:

- Per utilizzare come PIN la parola "**password**" occorrerà premere i seguenti tasti:  
7 (pqrs) 2 (abc) 7 (pqrs) 7 (pqrs) 9 (wxyz) 6 (mno) 7 (pqrs) 3 (def)
- Per utilizzare come PIN la parola "**kingston**" occorrerà premere i seguenti tasti:  
5 (jkl) 4 (ghi) 6 (mno) 4 (ghi) 7 (pqrs) 8 (tuv) 6 (mno) 6 (mno)

Questo metodo consente di creare PIN facili da ricordare a lungo.

Istruzioni	LED	Stato LED
1. Premere il pulsante CHIAVE una sola volta 		I LED <b>Rosso</b> , <b>Verde</b> & <b>Blu</b> si accenderanno insieme per una volta, quindi continuerà a lampeggiare il solo LED <b>Rosso</b>
2. Entro 10 secondi, iniziare a immettere il PIN utente (preimpostato - 11223344) per sbloccare l'unità DT2000		Il LED <b>Rosso</b> continuerà a lampeggiare
3. Premere il pulsante CHIAVE una sola volta 		Si accenderà un LED fisso che cambierà colore da <b>Rosso</b> a <b>Verde</b> : ciò indica il corretto inserimento del PIN utente preimpostato in fabbrica.
4. Premere due volte il pulsante CHIAVE (doppio clic) 		Il LED <b>Blu</b> lampeggia
5. Entro 10 secondi iniziare a immettere il Nuovo PIN utente		Il LED <b>Blu</b> continua a lampeggiare
6. Premere due volte il pulsante CHIAVE (doppio clic) 		Il LED <b>Verde</b> lampeggia
7. Entro 10 secondi iniziare a immettere una seconda volta il Nuovo PIN utente		Il LED <b>Verde</b> continua a lampeggiare
8. Premere due volte il pulsante CHIAVE (doppio clic) 		Si accenderà un LED fisso che cambierà colore da <b>Rosso</b> a <b>Verde</b> , a indicare che la modifica del PIN utente è stata impostata correttamente









**Nota:** nel caso venisse commesso un errore durante la procedura di modifica del PIN utente, così come nel caso che la procedura venisse interrotta, l'unità conserverà il precedente PIN.

## 5. Come attivare le opzioni













La modalità Opzioni consente all'utente di conoscere la versione del dispositivo e di accedere a diverse funzioni, quali l'attivazione o la disattivazione dell'impostazione di "Read-Only" o del "blocco automatico a tempo".

La tabella seguente mostra come accedere alla modalità Opzioni, mentre le sezioni da 6 a 9 descrivono come utilizzare le varie funzioni.

Istruzioni	LED	Stato LED
1. Premere il pulsante CHIAVE una sola volta 		I LED <b>Rosso</b> , <b>Verde</b> & <b>Blu</b> si accenderanno insieme per una volta, quindi continuerà a lampeggiare il solo LED <b>Rosso</b>
2. Entro 10 secondi, immettere il PIN utente (preimpostato - 11223344) per sbloccare l'unità DT2000		Il LED <b>Rosso</b> continuerà a lampeggiare
3. Premere il pulsante CHIAVE una sola volta 		Si accenderà un LED fisso che cambierà colore da <b>Rosso</b> a <b>Verde</b> ad indicare il corretto inserimento del PIN utente
4. Premere tre volte il pulsante CHIAVE (triplo clic) 		I LED <b>Verde</b> e <b>Blu</b> lampeggeranno simultaneamente in attesa di istruzioni nella modalità OPZIONI

## 6. Come attivare la modalità Read-Only

L'unità DT2000 dispone di una modalità di Sola lettura, che impedisce l'accesso in scrittura al drive. Per attivare questa modalità, eseguire le operazioni descritte di seguito.

Istruzioni	LED	Stato LED
1. Sbloccare l'unità DT2000 con il PIN utente	 → 	Si accenderà un LED fisso che cambierà colore da <b>Rosso</b> a <b>Verde</b> a indicare il corretto inserimento del PIN utente
2. Attivare la modalità Opzioni, premendo il pulsante CHIAVE 3 volte (triplo clic)   	 & 	I LED <b>Verde</b> e <b>Blu</b> lampeggeranno simultaneamente in attesa di istruzioni nella modalità OPZIONI.
3. Entro 10 secondi, premere il pulsante numero 7 ( <b>pqrs</b> ) seguito dal pulsante numero 6 ( <b>mno</b> ) (76)	 & 	I LED <b>Verde</b> e <b>Blu</b> continueranno a lampeggiare simultaneamente
4. Premere il pulsante CHIAVE una sola volta 	 → 	Il LED <b>Blu</b> cambia rapidamente colore in <b>Verde</b> fisso - quando l'unità DT2000 viene inserita in una porta USB, il LED <b>Verde</b> lampeggia ogni 2 secondi a indicare che il drive è in modalità Read-Only













Una volta attivata questa modalità, l'accesso sarà limitato alla sola lettura, fino alla successiva rimozione del divieto di scrittura.



**Nota:** è stata scelta un'apposita convenzione che consenta all'utente di ricordare facilmente i pulsanti da premere per configurare le diverse impostazioni. Nella precedente tabella sono stati utilizzati i numeri che rappresentano le "prime lettere" del nome della funzione. Ad esempio, **Read-Only** = 7 (pqrs) 6 (mno).

## 7. Come attivare la modalità Read/Write

Per disattivare il divieto di scrittura (Read-Only), è sufficiente ripristinare la modalità di accesso Read/Write. A questo scopo, eseguire le operazioni descritte di seguito.

Istruzioni	LED	Stato LED
1. Sbloccare l'unità DT2000 con il PIN utente	 → 	Si accenderà un LED fisso che cambierà colore da <b>Rosso</b> a <b>Verde</b> a indicare il corretto inserimento del PIN utente
2. Attivare la modalità Opzioni, premendo il pulsante CHIAVE 3 volte (triplo clic)   	 & 	I LED <b>Verde</b> e <b>Blu</b> lampeggeranno simultaneamente in attesa di istruzioni nella modalità OPZIONI.
3. Entro 10 secondi, premere il pulsante numero 7 ( <b>pqrs</b> ) seguito dal pulsante numero 9 ( <b>wxyz</b> ) (79)	 & 	I LED <b>Verde</b> e <b>Blu</b> continueranno a lampeggiare simultaneamente
4. Premere il pulsante CHIAVE una sola volta 	 → 	Il LED <b>Blu</b> cambia rapidamente colore in <b>Verde</b> fisso - quando l'unità DT2000 viene inserita in una porta USB, il LED <b>Verde</b> lampeggia ogni 2 secondi a indicare che il drive è in modalità Read/Write









Una volta attivata questa modalità, l'accesso viene ripristinato allo stato Read/Write predefinito.

## 8. Come attivare la modalità Timeout Lock

Quando l'unità DT2000 si trova connessa a un dispositivo ed è fuori dall'attenzione del proprietario, è possibile attivare una modalità che provoca il blocco automatico della stessa una volta trascorso un determinato periodo di tempo, così da proteggerla da accessi non autorizzati.









Per impostazione predefinita, questa modalità è disattivata. La modalità Timeout Lock può attivare il blocco (lock) dell'unità al termine di un intervallo di tempo compreso tra 1 e 99 minuti.

Per configurare al modalità Timeout Lock, eseguire le operazioni descritte nella tabella seguente:







Istruzioni	LED	Stato LED
1. Sbloccare l'unità DT2000 con il PIN utente		Si accenderà un LED fisso che cambierà colore da <b>Rosso</b> a <b>Verde</b> a indicare il corretto inserimento del PIN utente
2. Attivare la modalità Opzioni, premendo il pulsante CHIAVE 3 volte (triplo clic) 		I LED <b>Verde</b> e <b>Blu</b> lampeggeranno simultaneamente in attesa di istruzioni nella modalità OPZIONI
3. Entro 10 secondi, premere il pulsante numero <b>8</b> (tuv) seguito dal pulsante numero <b>5</b> (jkl) - ( <b>85</b> )		I LED <b>Verde</b> e <b>Blu</b> continueranno a lampeggiare simultaneamente
4. Premere il pulsante CHIAVE una sola volta 		LED <b>Verde</b> lampeggiante
5. Entro 10 secondi immettere la durata dell'intervallo temporale usando 2 cifre: 00 = 0 minuti (predefinito) 01 = 1 minuto 99 = 99 minuti, ecc.		Il LED <b>Verde</b> continua a lampeggiare
6. Premere il pulsante CHIAVE una sola volta 		Il LED <b>Verde</b> è acceso fisso - Il blocco a tempo è stato impostato

## 9. Come disattivare la modalità Timeout Lock

Per disattivare al modalità Timeout Lock, eseguire le operazioni descritte nella tabella seguente:

Istruzioni	LED	Stato LED
1. Sbloccare l'unità DT2000 con il PIN utente		Si accenderà un LED fisso che cambierà colore da <b>Rosso</b> a <b>Verde</b> a indicare il corretto inserimento del PIN utente
2. Attivare la modalità Opzioni, premendo il pulsante CHIAVE 3 volte (triplo clic) 		I LED <b>Verde</b> e <b>Blu</b> lampeggeranno simultaneamente in attesa di istruzioni nella modalità OPZIONI
3. Entro 10 secondi, premere il pulsante numero <b>8</b> (tuv) seguito dal pulsante numero <b>5</b> (jkl) - ( <b>85</b> )		I LED <b>Verde</b> e <b>Blu</b> continueranno a lampeggiare simultaneamente
4. Premere il pulsante CHIAVE una sola volta 		LED <b>Verde</b> lampeggiante
5. Entro 10 secondi premere il numero <b>0</b> due volte (doppio clic) ( <b>zero zero</b> ) - ( <b>00</b> )		Il LED <b>Verde</b> continua a lampeggiare
6. Premere il pulsante CHIAVE una sola volta 		Il LED <b>Verde</b> è acceso fisso - Il blocco a tempo è stato disattivato

## 10. Come individuare il numero di versione dell'unità DT2000

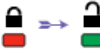
Istruzioni	LED	Stato LED
1. Sbloccare l'unità DT2000 con il PIN utente		Si accenderà un LED fisso che cambierà colore da <b>Rosso</b> a <b>Verde</b> a indicare il corretto inserimento del PIN utente
2. Attivare la modalità Opzioni, premendo il pulsante CHIAVE 3 volte (triplo clic) 		I LED <b>Verde</b> e <b>Blu</b> lampeggeranno simultaneamente in attesa di istruzioni nella modalità OPZIONI
3. Entro 10 secondi, premere il pulsante numero <b>8</b> ( <b>tu</b> v) seguito dal numero <b>6</b> ( <b>m</b> no) - ( <b>86</b> )		I LED <b>Verde</b> e <b>Blu</b> continueranno a lampeggiare simultaneamente
4. Premere il pulsante CHIAVE una sola volta 	 	I LED <b>Rosso</b> , <b>Verde</b> e <b>Blu</b> lampeggeranno rapidamente insieme per una volta, dopo di che il LED <b>Rosso</b> lampeggerà un numero di volte pari alla prima cifra della versione, seguito dal LED <b>Verde</b> che lampeggerà un numero di volte pari alla seconda cifra della versione.
Ad esempio, se la versione è "1.8", il LED <b>Rosso</b> lampeggerà una volta (1) e il LED <b>Verde</b> lampeggerà (8) volte. Al termine della sequenza i LED <b>Rosso</b> , <b>Verde</b> e <b>Blu</b> lampeggeranno insieme una volta, per poi lasciare il solo LED <b>Verde</b> acceso fisso.		

## 11. Come rilevare un'intrusione di tipo Brute Force



**Attenzione:** se un utente immette un PIN utente errato per 10 (dieci) volte consecutive, verrà automaticamente attivato il meccanismo di difesa dagli attacchi cd. "brute force", che prevede la cancellazione del PIN utente, della chiave di crittografia e di **tutti i dati**, che andranno quindi definitivamente persi.

PIN utilizzato per sbloccare l'unità DT2000	Cosa accade dopo 10 immissioni consecutive di PIN utente errati?
PIN utente	L'unità DT2000 attiva automaticamente il meccanismo di difesa dagli attacchi cd. "brute force", che prevede la cancellazione del PIN utente, della chiave di crittografia e di tutti i dati, che andranno quindi definitivamente persi.

Se un utente immette un PIN utente errato per 10 (dieci) volte consecutive, il PIN utente, la chiave di crittografia e tutti i dati verranno cancellati e andranno quindi definitivamente persi. L'unità DT2000 verrà quindi riportata alle impostazioni di fabbrica, con il PIN utente preimpostato - 11223344. Per istruzioni relative alla modifica del PIN utente, vedere la sezione 4 a pagina 6. Inoltre, dal momento che questa procedura determina la creazione di una nuova chiave di crittografia, l'unità DT2000 verrà formattata (vedere le sezioni 13 o 14).

L'unità DT2000, a differenza di altri prodotti analoghi, incorpora un generatore numerico casuale. Una volta reimpostato il drive, viene automaticamente generata una nuova chiave in modo casuale.









## 12. Come riportare l'unità DT2000 alle impostazioni di fabbrica

Nel caso in cui il proprietario dell'unità DT2000 dimenticasse il PIN utente o volesse cancellare tutti i dati presenti nel drive, è possibile utilizzare la procedura descritta di seguito.

La procedura di reimpostazione cancella tutti i parametri di crittografia, incluso il PIN utente. Ciò implica che l'unità DT2000 sarà riportata alle impostazioni di fabbrica, con il PIN utente preimpostato - 11223344. Per istruzioni relative alla modifica del PIN utente, vedere la sezione 4 a pagina 6. Inoltre, dal momento che questa procedura determina la creazione di una nuova chiave di crittografia, l'unità DT2000 verrà formattata (vedere le sezioni 13 o 14).



**Attenzione:** la procedura di reimpostazione dell'unità DT2000 prevede la cancellazione **tutti i dati** archiviati nel drive.

Istruzioni	LED	Stato LED
1. Tenere premuto il pulsante numero <b>7</b> (pqrs), quindi premere il pulsante CHIAVE  . Rilasciare i pulsanti ( <b>7</b> e  )	 / 	I LED <b>Rosso</b> e <b>Verde</b> lampeggiano alternativamente
2. Entro 10 secondi premere il pulsante numero <b>9</b> (wxyz) tre volte (triplo clic) ( <b>999</b> )	 / 	I LED <b>Rosso</b> e <b>Verde</b> continuano a lampeggiare alternativamente
3. Tenere premuto il pulsante numero <b>7</b> (pqrs), quindi premere il pulsante CHIAVE  . Rilasciare i pulsanti ( <b>7</b> &  )		Il LED <b>Rosso</b> si spegne lentamente ad indicare il completamento della procedura di reimpostazione



## 13. Come configurare l'unità DT2000 con un sistema operativo Windows

Nel caso in cui sia stata attivata la procedura di difesa da un attacco hacker a seguito dell'immissione consecutiva di **10 PIN utente errati**, così come nel caso di **reimpostazione** dell'unità alle impostazioni di fabbrica, **tutti i dati originariamente presenti nel drive andranno definitivamente persi**.

Dopo la creazione di un nuovo **PIN utente**, l'unità DT2000 dovrà essere inizializzata e formatta.

### Per inizializzare l'unità DT2000:

1. Creare un nuovo **PIN utente** (vedere la sezione 4).
2. Sbloccare l'unità DT2000 inserendo il nuovo **PIN utente** e collegarla alla porta USB di un computer.
3. Il computer visualizzerà il seguente messaggio:

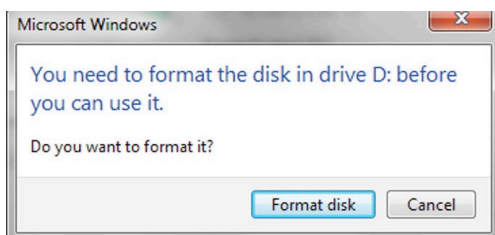

4. Proseguire facendo clic sul pulsante **Format disk** (formatta il disco). Selezionare **FAT32** o **NTFS** in base alle proprie esigenze, immettere una **Volume Label** (etichetta di volume) e fare clic su **Start** (avvia).

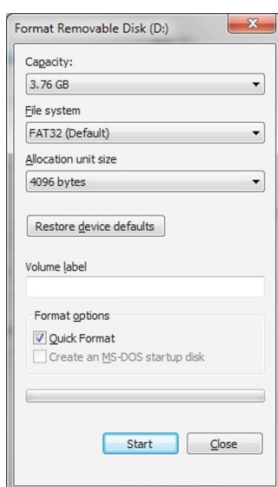

5. Fare clic su **OK** per procedere alla formattazione del drive.

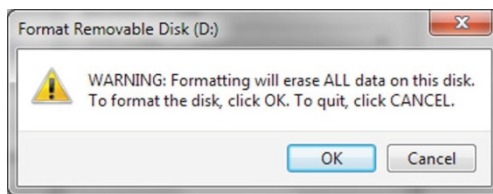

**Attenzione:** Questa procedura cancellerà **tutti i dati** presenti nel drive.

6. Il computer completerà la procedura di formattazione visualizzando un messaggio di conferma. Durante la procedura di formattazione, sull'unità DT2000 lampeggerà il LED **Blu**.

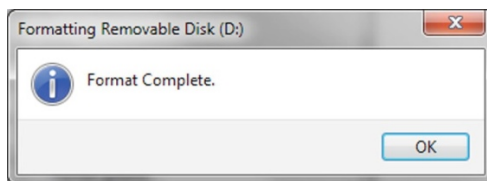

Al termine, il LED **Blu** diventa fisso ad indicare che l'unità DT2000 è pronta all'uso.

**Nel caso in cui non venisse visualizzata la procedura guidata di formattazione, procedere come segue:**

1. Fare clic con il pulsante destro del mouse su **My Computer** o **Computer**, quindi fare clic su **Manage** (gestione).
2. Nella scheda **Disk Management** (gestione disco) della finestra **Computer Management** (gestione computer), l'unità DT2000 viene riconosciuta come dispositivo rimovibile in formato RAW.

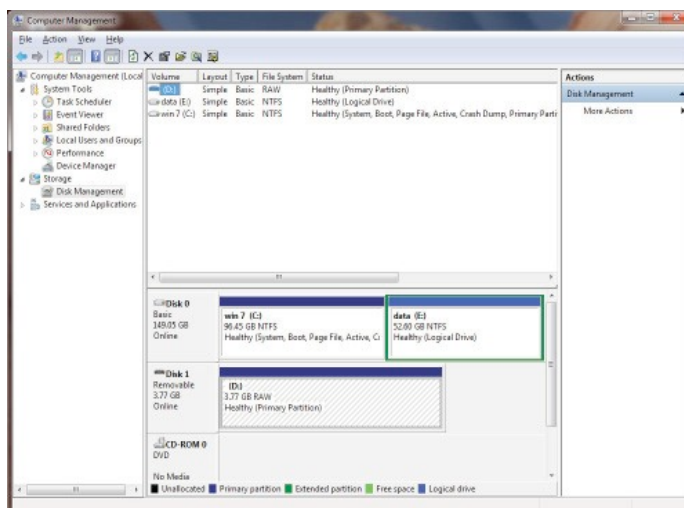

3. Nell'area vuota della sezione non allocata, fare clic con il pulsante destro del mouse su **Removable Raw Drive** (drive RAW rimovibile) e selezionare **Format** (formatta).

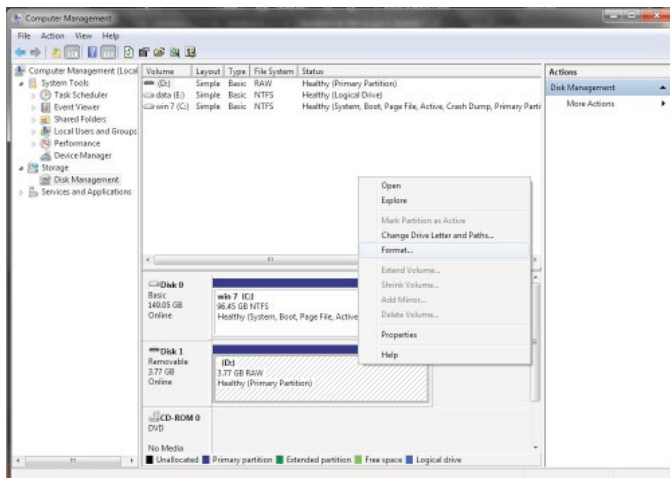

4. Viene aperta la finestra di dialogo **Format** (formatta). Immettere la nuova **Volume Label** (etichetta di volume). Selezionare **FAT32** o **NTFS** in base alle proprie esigenze e fare clic su **OK**.

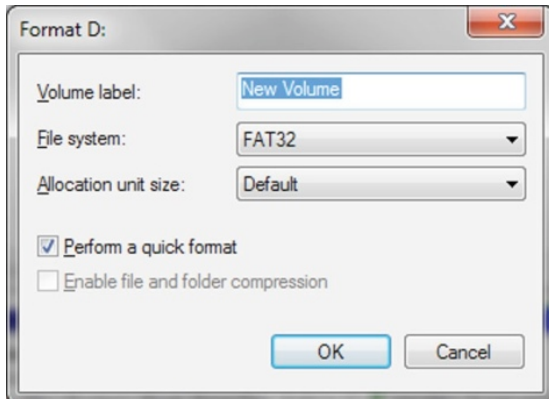

5. Fare clic su **OK** nella finestra di dialogo **Format** (formatta) per avviare la procedura di formattazione del drive.

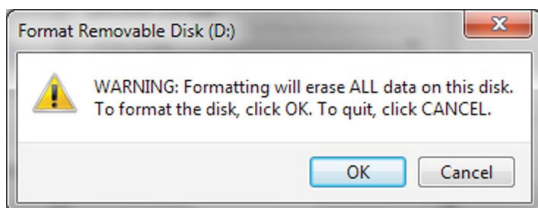

**Attenzione:** Questa procedura cancellerà **tutti i dati** presenti nel drive.

6. Il computer completerà la procedura di formattazione e tornerà alla visualizzazione della finestra **Disk Management** (gestione disco).

Durante la procedura di formattazione, sull'unità DT2000 lampeggerà il LED **Blu**.

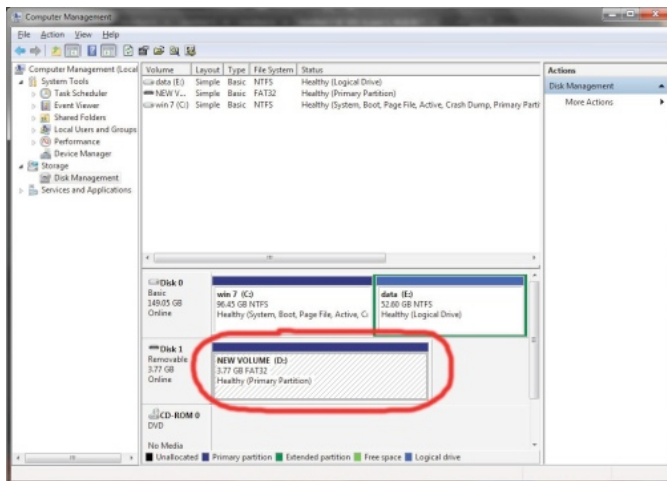

Al termine, il LED **Blu** diventa fisso ad indicare che l'unità DT2000 è pronta all'uso.

## 14. Come configurare l'unità DT2000 con un sistema operativo Mac

Nel caso in cui sia stata attivata la procedura di difesa da un attacco hacker a seguito dell'immissione consecutiva di 10 PIN errati, così come nel caso di reimpostazione dell'unità alle impostazioni di fabbrica, **tutti i dati originariamente presenti nel drive andranno definitivamente persi**.

Dopo la creazione di un nuovo **PIN utente**, l'unità DT2000 dovrà essere inizializzata e formata.

Per formattare l'unità DT2000 nei computer con SO Mac, procedere come segue:

1. Creare un nuovo **PIN utente** (vedere la sezione 4).
2. Sbloccare l'unità DT2000 inserendo il nuovo **PIN utente** e collegarla alla porta USB di un computer Mac. Il sistema visualizzerà un messaggio in cui viene richiesto se **INIZIALIZZARE** il drive.

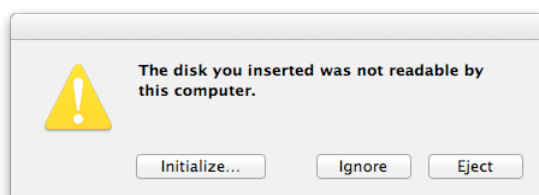

3. Premere **INITIALIZE** (inizializza) e selezionare l'unità DT2000 nella finestra **Disk Utility** (utilità disco).

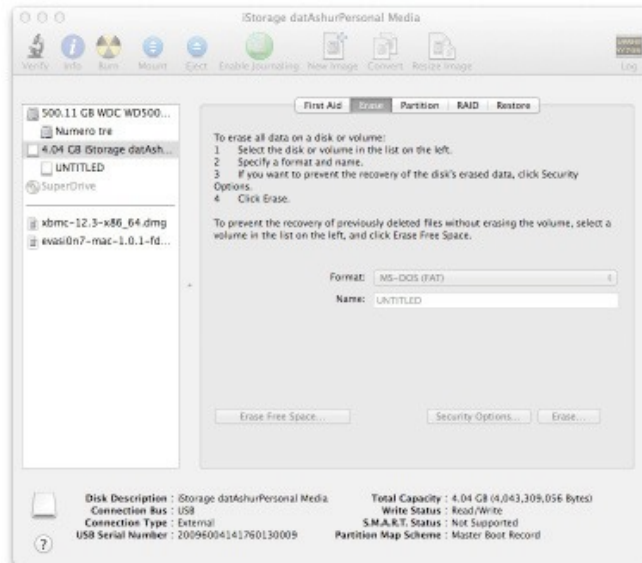

4. Fare clic sull'unità DT2000 nella parte sinistra della finestra **Disk Utility**.
5. Scegliere **Erase** (cancella) dal menu a comparsa nella parte sinistra della finestra. Selezionare **MS-DOS** per il **Volume Format** (formato volume).
6. Fare clic su **Erase** (cancella).

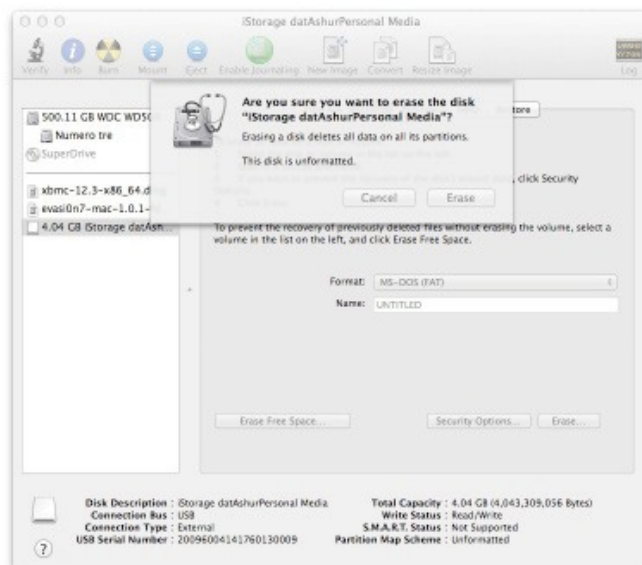

7. L'unità DT2000 formattata verrà visualizzata nella finestra **Disk Utility** e sarà disponibile dal desktop.

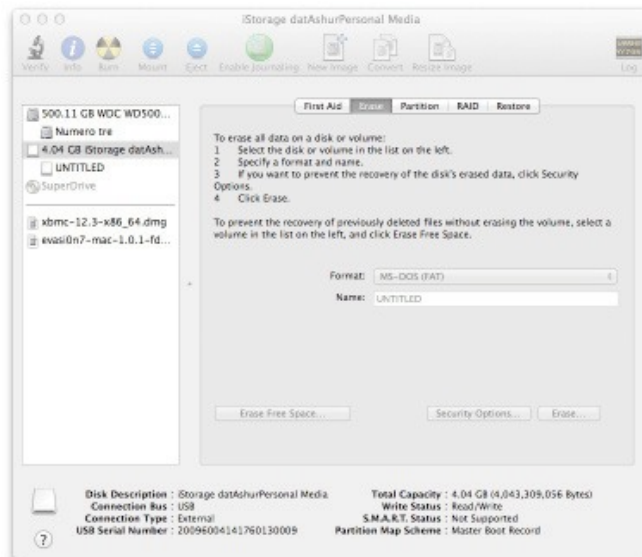

## Informazioni sulla batteria / Smaltimento del prodotto

Non smaltire mai prodotti contenenti batterie o altre parti elettriche insieme ai rifiuti comuni. I prodotti elettrici devono essere smaltiti in modo responsabile così da ridurre al minimo l'impatto ambientale. Non provare mai a rimuovere la batteria dal prodotto: questa operazione deve essere compiuta esclusivamente da Kingston o da un fornitore di assistenza professionale. Per ulteriori informazioni sul corretto smaltimento della batteria e sulle procedure per riciclare responsabilmente il prodotto, la invitiamo a [contatarci](#).

DataTraveler® 2000 incorpora la tecnologia DataLock® su licenza di ClevX, LLC.

## Manual do Usuário - DataTraveler® 2000



**Lembre-se de salvar seu PIN em um local seguro. Se for perdido ou esquecido, não há como acessar os dados armazenados no Kingston DataTraveler®.**

**Se estiver com dificuldades, consulte este guia do usuário completo carregado em seu DT2000, também disponível no site da Kingston: [kingston.com/support](http://kingston.com/support)**

DataTraveler® 2000 incorpora a Tecnologia DataLock® licenciada pela ClevX, LLC.



## Índice

Requisitos do Sistema .....	3
Introdução.....	4
1. Layout do DT2000 .....	5
2. Indicadores LED e suas funções.....	5
3. Como usar o DT2000 pela primeira vez.....	6
4. Como mudar o PIN de usuário.....	6
5. Como habilitar as Opções .....	7
6. Como habilitar o modo somente leitura .....	8
7. Como habilitar o Modo Leitura/Gravação.....	8
8. Como instalar o modo de bloqueio por tempo limite.....	9
9. Como desativar o modo de Bloqueio por tempo limite.....	9
10. Como determinar o número da versão do DT2000.....	10
11. Detecção de ataque de hacker por força bruta .....	10
12. Como reconfigurar o DT2000.....	11
13. Como configurar o DT2000 com o Sist. Operacional Windows .....	12
14. Como configurar o DT2000 com o Sist. Operacional Mac.....	15





## Sobre este Manual do Usuário

Este manual do usuário é específico para o Kingston's DataTraveler® 2000 (mencionado daqui em diante simplesmente como DT2000).

## Requisitos do Sistema

---

### Plataforma de PC

### Suporte do Sistema Operacional do PC

- Windows 10
  - Windows 8/8.1
  - Windows 7
  - Windows Vista® SP2
- 

### Plataforma Mac

### Suporte do Sistema Operacional

- Mac OS X 10.8.x - 10.11x
- 

### Plataforma Linux

### Suporte do Sistema Operacional

- Linux v2.6 kernel ou superior
- 

### Outras Plataformas

### Suporte do Sistema Operacional

- Chrome OS™, Android\*
- 

\*Apenas dispositivos compatíveis. Verifique com o fabricante de seu dispositivo se ele suporta Unidades Flash USB.

## Introdução



**Observação:** A bateria recarregável do DT2000 não vem totalmente carregada. Recomendamos que a bateria seja carregada antes de usar pela primeira vez. Para carregar, conecte o plugue do DT2000 em uma porta USB por 60 minutos para carregar totalmente a bateria.

Obrigado por adquirir o DataTraveler® 2000, uma unidade flash USB 3.0 criptografada, ultrassegura e fácil de usar, ativada por PIN.



O DT2000 utiliza criptografia de hardware de nível militar XTS-AES 256-bit que criptografa todos os dados armazenados na unidade em tempo real. O DT2000 não necessita de software e é independente do sistema operacional e do host.

O DT2000 incorpora uma bateria recarregável, permitindo ao usuário digitar um PIN (Número de Identificação Pessoal) de 7 a 15 dígitos no teclado disponível antes de conectar a unidade a uma porta USB.

Se a unidade for perdida ou roubada, o usuário pode ficar tranquilo que todos os dados armazenados no DT2000 não poderão ser acessados por pessoas não autorizadas.

O DT2000 é desbloqueado através do teclado integrado e não através de um computador. Não é vulnerável a key-loggers ou ataques de força bruta com base em software ou hardware.









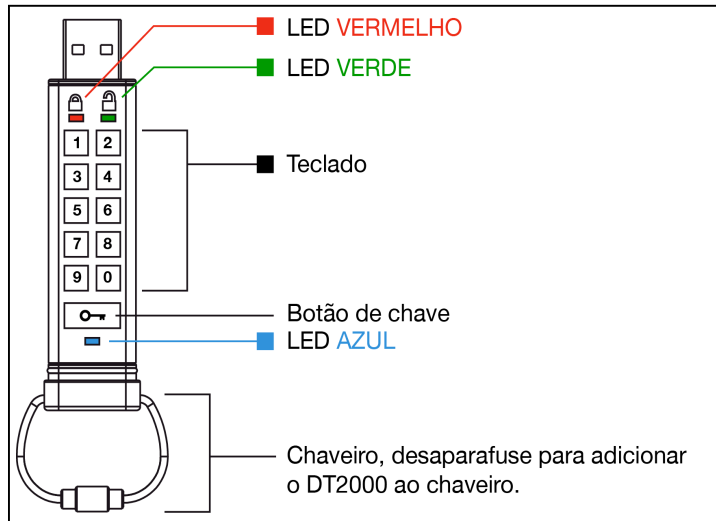







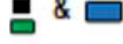

**Cuidado:** O DT2000 é embarcado com um PIN padrão  1-1-2-2-3-3-4-4  e embora possa ser usado assim que adquirido com o PIN padrão, por razões de segurança, é **altamente recomendado que um novo PIN de Usuário seja criado imediatamente** seguindo as instruções da seção 4 “Como alterar o PIN de usuário”.

Se você esquecer seu PIN todos os dados ficarão inacessíveis.

## 1. Layout do DT2000







## 2. Indicadores LED e suas funções

LED	Estado do LED	Descrição	Estado do LED	Descrição	Descrição
	<b>Vermelho Preto</b> desaparecimento gradual 	Bloqueio/entrada de PIN incorreto		<b>Vermelho e Verde</b> piscando alternadamente 	Retorna às configurações de fábrica
	<b>Vermelho</b> piscando 	Bloqueado e aguardando entrada de PIN padrão de fábrica ou PIN definido			
	<b>Verde</b> sólido 	DT2000 é desbloqueado		<b>Verde e Azul</b> piscando juntos 	Modo Opção do Usuário
	<b>Verde</b> piscando 	Quando conectado a uma porta USB se o LED <b>Verde</b> piscar a cada 2 segundos isso indica que o DT2000 foi configurado para "Somente leitura"			
	<b>Azul</b> sólido 	Conectado a uma porta USB			
	<b>Azul</b> piscando 	Troca de dados com host/mudando PIN de usuário			

### 3. Como usar o DT2000 pela primeira vez

O DT2000 é embarcado com um PIN padrão 11223344 e embora possa ser usado assim que adquirido com o PIN padrão, por razões de segurança, é altamente recomendado que um novo PIN de Usuário seja criado imediatamente seguindo as instruções da seção 4 “Como alterar o PIN de usuário”.

Por favor, siga os 3 passos simples na tabela abaixo para desbloquear o DT2000 com o PIN padrão.

Instruções (uso pela primeira vez)	LED	Estado do LED
1. Pressione o botão KEY (chave) uma vez 		Os LEDs <b>Vermelho</b> , <b>Verde</b> e <b>Azul</b> piscarão uma vez juntos e depois o LED <b>Vermelho</b> continuará a piscar
2. Em 10 segundos digite o PIN de Usuário (padrão - 11223344) para desbloquear o DT2000		O LED <b>Vermelho</b> continuará a piscar
3. Pressione o botão KEY (chave) uma vez 		O LED <b>Vermelho</b> sólido muda para LED <b>Verde</b> sólido, indicando entrada bem sucedida de PIN de usuário padrão



**Observação:** Depois que o DT2000 tiver sido desbloqueado com sucesso, o LED **Verde** permanecerá ligado e sólido por apenas 30 segundos e durante esse tempo o DT2000 precisa ser conectado a uma porta USB. Ele pode ser bloqueado imediatamente pressionando e mantendo pressionado o botão KEY (chave)  por 3 segundos, ou esperando expirar os 30 segundos ou clicando no ícone “Remove Hardware e Ejetar Mídia” com Segurança em seu sistema operacional.

### 4. Como mudar o PIN de usuário

Requisitos do PIN:

- Deve ter entre 7 e 15 dígitos
- Não deve conter apenas números repetidos, por exemplo, (3-3-3-3-3-3)
- Não deve conter apenas números consecutivos, por exemplo, (1-2-3-4-5-6-7), (7-8-9-0-1-2-3-4), (7-6-5-4-3-2-1)

**Dica de senha:** Você pode criar uma palavra, nome, frase ou qualquer outra combinação alfanumérica inesquecível de PIN simplesmente pressionando as teclas com as letras correspondentes.

Exemplos desses tipos de PIN alfanuméricos são:

- Para a palavra “**password**” você iria pressionar as seguintes teclas: **7** (pqrs) **2** (abc) **7** (pqrs) **7** (pqrs) **9** (wxyz) **6** (mno) **7** (pqrs) **3** (def)
- Para “**kingston**” você iria pressionar: **5** (jkl) **4** (ghi) **6** (mno) **4** (ghi) **7** (pqrs) **8** (tuv) **6** (mno) **6** (mno)

Usando este método, podem ser criados PINs longos e fáceis de lembrar.

Instruções	LED	Estado do LED
1. Pressione o botão KEY (chave) uma vez 		Os LEDs <b>Vermelho</b> , <b>Verde</b> e <b>Azul</b> piscarão uma vez juntos e depois o LED <b>Vermelho</b> continuará a piscar
2. Em 10 segundos comece a digitar o PIN de Usuário (padrão - 11223344) para desbloquear o DT2000		O LED <b>Vermelho</b> continuará a piscar
3. Pressione o botão KEY (chave) uma vez 		O LED <b>Vermelho</b> sólido muda para LED <b>Verde</b> sólido, indicando entrada bem sucedida de PIN de usuário padrão
4. Pressione o botão KEY duas vezes (clique duplo) 		O LED <b>Azul</b> piscará
5. Em 10 segundos comece a digitar o Novo PIN de Usuário		O LED <b>Azul</b> continua a piscar
6. Pressione o botão KEY duas vezes (clique duplo) 		O LED <b>Verde</b> piscará
7. Em 10 segundos comece a digitar novamente o Novo PIN de Usuário		O LED <b>Verde</b> continua a piscar
8. Pressione o botão KEY duas vezes (clique duplo) 		O LED <b>Vermelho</b> sólido muda para LED <b>Verde</b> sólido, indicando mudança bem sucedida do PIN de usuário









**Observação:** Se for cometido um erro ao definir um novo PIN de usuário ou se o procedimento não for concluído, a unidade irá reter o PIN antigo.

## 5. Como habilitar as Opções





O modo Opções irá permitir ao Usuário executar diferentes funções como habilitar ou desabilitar o DT2000 como "Somente leitura", definir um bloqueio automático "por tempo limite" e determinar a versão do dispositivo.

A tabela abaixo ilustra como acessar o modo Opções, as seções 6 a 9 descrevem como executar as várias funções.

Instruções	LED	Estado do LED
1. Pressione o botão KEY (chave) uma vez 		Os LEDs <b>Vermelho</b> , <b>Verde</b> e <b>Azul</b> piscarão uma vez juntos e depois o LED <b>Vermelho</b> continuará a piscar
2. Em 10 segundos digite o PIN de usuário (padrão - 11223344) para desbloquear o DT2000		O LED <b>Vermelho</b> continuará a piscar
3. Pressione o botão KEY (chave) uma vez 		O LED <b>Vermelho</b> sólido muda para LED <b>Verde</b> sólido, indicando entrada bem sucedida do PIN de usuário
4. Pressione o botão KEY três vezes (clique triplo) 		Os LEDs <b>Verde</b> e <b>Azul</b> piscarão juntos aguardando novas instruções no modo OPÇÕES.

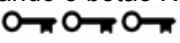
## 6. Como habilitar o modo somente leitura

O DT2000 possui um modo somente leitura que restringe o acesso de gravação na unidade. Isto é feito seguindo os seguintes passos.

Instruções	LED	Estado do LED
1. Desbloqueie o DT2000 com o PIN de Usuário		O LED <b>Vermelho</b> sólido muda para LED <b>Verde</b> sólido, indicando entrada bem sucedida do PIN de usuário
2. Habilite Opções pressionando o botão KEY três vezes (clique triplo) 		Os LEDs <b>Verde</b> e <b>Azul</b> piscarão juntos aguardando novas instruções no modo OPÇÕES
3. Em 10 segundos comece a pressionar o número 7 (pqrs) seguido pelo número 6 (mno) (76)		Os LEDs <b>Verde</b> e <b>Azul</b> continuam a piscar juntos
4. Pressione o botão KEY (chave) uma vez 		O LED <b>Azul</b> transforma-se rapidamente em <b>Verde</b> sólido - quando o DT2000 é inserido em uma porta USB, o LED <b>Verde</b> pisca a cada dois segundos, indicando que a unidade está em Modo Somente Leitura

Uma vez ativado, o acesso é limitado a Somente leitura até que a proteção contra gravação seja desabilitada.









**Observação:** Aplicamos uma convenção por nomes para que o usuário lembre-se das teclas para cada configuração opcional. Na tabela acima, usamos números que representam as “primeiras letras” do nome do recurso opcional. Por exemplo, para somente leitura: **Read-Only** = 7 (pqrs) 6 (mno).

## 7. Como habilitar o Modo Leitura/Gravação

O acesso restrito protegido contra gravação (somente leitura) pode ser desativado com o acesso restaurado para Leitura/Gravação.

Isto é feito seguindo os seguintes passos.

Instruções	LED	Estado do LED
1. Desbloqueie o DT2000 com o PIN de Usuário		O LED <b>Vermelho</b> sólido muda para LED <b>Verde</b> sólido, indicando entrada bem sucedida do PIN de usuário
2. Habilite Opções pressionando o botão KEY três vezes (clique triplo) 		Os LEDs <b>Verde</b> e <b>Azul</b> piscarão juntos aguardando novas instruções no modo OPÇÕES
3. Em 10 segundos digite o número 7 (pqrs) seguido pelo número 9 (wxyz) (79)		Os LEDs <b>Verde</b> e <b>Azul</b> continuam a piscar juntos
4. Pressione o botão KEY (chave) uma vez 		O LED <b>Azul</b> transforma-se rapidamente em <b>Verde</b> sólido - quando o DT2000 é inserido em uma porta USB, o LED <b>Verde</b> pisca a cada dois segundos, indicando que a unidade está em Modo Leitura/Gravação















Uma vez ativado, o acesso é restaurado para o estado Leitura/Gravação padrão.

## 8. Como instalar o modo de bloqueio por tempo limite

Para proteger-se contra acesso não autorizado quando o DT2000 está conectado a um host e é deixado desacompanhado, o DT2000 pode ser configurado para bloquear-se automaticamente após um tempo predefinido.















Em seu estado padrão, o recurso Bloqueio por tempo limite do DT2000 está ativado. O recurso Bloqueio por tempo limite pode ser configurado para ser ativado (bloquear) entre 1 e 99 minutos.

Para configurar o Bloqueio por tempo limite, siga os passos na tabela abaixo.







Instruções	LED	Estado do LED
1. Desbloqueie o DT2000 com o PIN de Usuário	 → 	O LED <b>Vermelho</b> sólido muda para LED <b>Verde</b> sólido, indicando entrada bem sucedida do PIN de usuário
2. Habilite Opções pressionando o botão KEY três vezes (clique triplo)   	 & 	Os LEDs <b>Verde</b> e <b>Azul</b> piscam juntos aguardando novas instruções no modo OPÇÕES
3. Em 10 segundos digite o número <b>8</b> (tuv) seguido pelo número <b>5</b> (jkl) - ( <b>85</b> )	 & 	Os LEDs <b>Verde</b> e <b>Azul</b> continuam a piscar juntos
4. Pressione o botão KEY (chave) uma vez 		LED <b>Verde</b> piscando
5. Em 10 segundos digite o Tempo limite do usuário com 2 dígitos: 00 = 0 minutos (Padrão) 01 = 1 minuto 99 = 99 minutos, etc.		O LED <b>Verde</b> continuará a piscar
6. Pressione o botão KEY uma vez 		LED <b>Verde</b> sólido - o Bloqueio por tempo limite foi habilitado

## 9. Como desativar o modo de Bloqueio por tempo limite

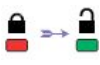
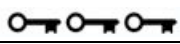
Para desabilitar o Bloqueio por tempo limite, siga os passos na tabela abaixo.

Instruções	LED	Estado do LED
1. Desbloqueie o DT2000 com o PIN de Usuário	 → 	O LED <b>Vermelho</b> sólido muda para LED <b>Verde</b> sólido, indicando entrada bem sucedida do PIN de usuário
2. Habilite Opções pressionando o botão KEY três vezes (clique triplo)   	 & 	Os LEDs <b>Verde</b> e <b>Azul</b> piscarão juntos aguardando novas instruções no modo OPÇÕES
3. Em 10 segundos digite o número <b>8</b> (tuv) seguido pelo número <b>5</b> (jkl) - ( <b>85</b> )	 & 	Os LEDs <b>Verde</b> e <b>Azul</b> continuam a piscar juntos
4. Pressione o botão KEY uma vez 		LED <b>Verde</b> piscando
5. Em 10 segundos digite o número <b>0</b> duas vezes (clique duplo) ( <b>zero zero</b> ) - ( <b>00</b> )		O LED <b>Verde</b> continuará a piscar
6. Pressione o botão KEY uma vez 		LED <b>Verde</b> sólido - o Bloqueio por tempo limite foi desabilitado

## 10. Como determinar o número da versão do DT2000

Instruções	LED	Estado do LED
1. Desbloqueie o DT2000 com o PIN de Usuário		O LED <b>Vermelho</b> sólido muda para LED <b>Verde</b> sólido, indicando entrada bem sucedida do PIN de usuário
2. Habilite Opções pressionando o botão KEY três vezes (clique triplo) 		Os LEDs <b>Verde</b> e <b>Azul</b> piscam juntos aguardando novas instruções no modo OPÇÕES
3. Em 10 segundos digite o número <b>8</b> (tu <b>v</b> ) seguido pelo número <b>6</b> (m <b>n</b> o) - ( <b>86</b> )		Os LEDs <b>Verde</b> e <b>Azul</b> continuam a piscar juntos
4. Pressione o botão KEY uma vez 	 	Os LEDs <b>Vermelho</b> , <b>Verde</b> e <b>Azul</b> rapidamente vão piscar juntos uma vez seguido pelo LED <b>Vermelho</b> piscando para o primeiro dígito significativo da revisão, em seguida o LED <b>Verde</b> irá piscar de acordo com o segundo dígito significativo do número da revisão

Por exemplo, se a revisão for número "1.8". o LED **Vermelho** irá piscar uma vez (1) e o LED **Verde** irá piscar oito (8) vezes. Quando a sequência tiver terminado, os LEDs **Vermelho**, **Verde** e **Azul** piscarão juntos uma vez e depois o LED **Verde** ficará sólido.

## 11. Detecção de ataque de hacker por força bruta



**Cuidado:** Se um usuário digitar um PIN incorreto 10 (dez) vezes consecutivas, o mecanismo contra força bruta do DT2000 irá disparar e o PIN de usuário, a chave de criptografia, **juntamente com todos os dados**, serão apagados e ficarão perdidos para sempre.

PIN usado para desbloquear o DT2000	O que acontece após 10 inserções consecutivas de um PIN incorreto?
PIN de usuário	O mecanismo contra força bruta do DT2000 irá disparar e o PIN do Usuário, a chave de criptografia e todos os dados serão apagados e ficarão perdidos para sempre.

Se o Usuário inserir um PIN incorreto 10 (dez) vezes consecutivas, a chave de criptografia e todos os dados serão apagados e ficarão perdidos para sempre. O DT2000 retornará ao PIN do Usuário padrão de fábrica, definido como 11223344 - consulte a seção 4 na página 6 sobre como mudar o PIN de Usuário. E também, já que isso irá forçar a criação de uma nova chave de criptografia, o DT2000 precisará ser reformatado (consulte a seção 13 ou 14).

O DT2000, diferentemente de outras unidades similares, incorpora um gerador de números randômicos. Quando a unidade é reconfigurada, uma nova chave de criptografia é randomicamente gerada.











## 12. Como reconfigurar o DT2000

No caso do PIN de usuário ser esquecido, ou se o usuário desejar excluir todos os dados armazenados no DT2000, siga as instruções abaixo.

O processo de reconfiguração irá limpar todos os parâmetros criptográficos, inclusive o PIN de Usuário. Isso significa que o DT2000 retornará ao PIN do Usuário padrão de fábrica, definido como 11223344 - consulte a seção 4 na página 6 sobre como mudar o PIN de Usuário. E também, já que isso irá forçar a criação de uma nova chave de criptografia, o DT2000 precisará ser reformatado (consulte a seção 13 ou 14).



**Cuidado:** Reformatar o DT2000 irá excluir **todos os dados** armazenados na unidade.

Instruções	LED	Estado do LED
1. Pressione e mantenha pressionado o número 7 (pqrs) e em seguida pressione o botão KEY  (chave). Libere os botões (7 &  )	 / 	<b>Vermelho</b> e <b>Verde</b> piscando alternadamente
2. Em 10 segundos digite o número 9 (wxyz) três vezes (clique triplo) (999)	 / 	Os LEDs <b>Vermelho</b> e <b>Verde</b> continuam a piscar alternadamente
3. Pressione e mantenha pressionado o número 7 (pqrs) e em seguida pressione o botão KEY  (chave). Libere os botões (7 &  )		O LED <b>Vermelho</b> desaparece gradualmente para concluir o processo de reconfiguração

## 13. Como configurar o DT2000 com o Sist. Operacional Windows

No caso da detecção de ataque de hacker tiver sido acionada inserindo-se o **PIN incorreto 10 vezes** sucessivas, ou se a unidade tiver sido **reformatada**, **todos os dados da unidade estarão perdidos para sempre**.

Depois que um novo **PIN de usuário** tiver sido criado, o DT2000 precisará ser inicializado e formatado.

**Para inicializar seu DT2000, faça o seguinte:**

1. Crie um novo **PIN de usuário** (consulte a seção 4).
2. Desbloqueie o DT2000 inserindo o novo **PIN de usuário** e conectando a uma porta USB de um computador.
3. O computador deve notificar o usuário com a seguinte mensagem:

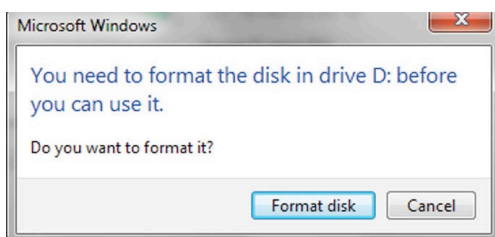

4. Prossiga clicando em **Formatar disco**. Selecione **FAT32** ou **NTFS** dependendo das suas necessidades, digite uma **Etiqueta de volume** e clique em **Iniciar**.

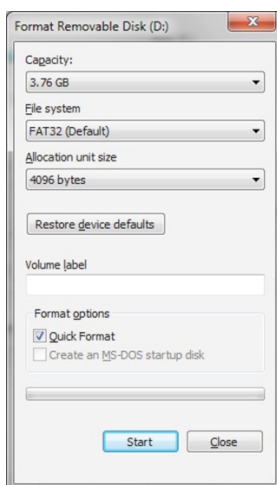

5. Clique em **OK** para continuar a formatação da unidade.



**Aviso:** Este procedimento irá excluir **todos os dados** armazenados na unidade.

6. O computador irá concluir a formatação da unidade e confirmar que a formatação está concluída. Enquanto o DT2000 estiver sendo formatado, o LED **Azul** ficará piscando.

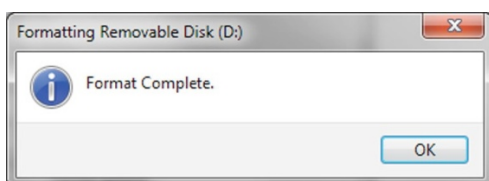

Quando concluído, o LED **Azul** torna-se sólido e seu DT2000 está pronto para usar.

**Se o assistente de formatação não aparecer, siga o procedimento abaixo:**

1. Clique com o botão direito em **Meu Computador** ou **Computador** e em seguida em **Gerenciar**.
2. Na janela **Gerenciamento do Computador** na guia **Gerenciamento de Disco**, o DT2000 é reconhecido como dispositivo removível em formato RAW.

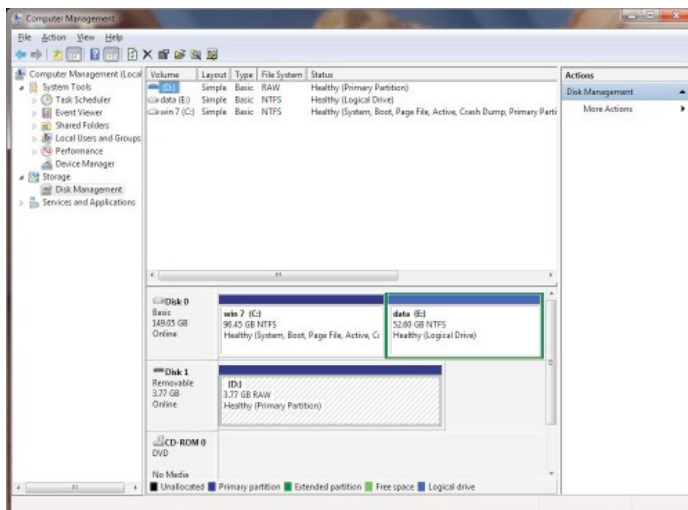

3. Na área vazia sob a seção não alocada, clique com o botão direito em **Unidade Removível Raw** e selecione **Formatar**.

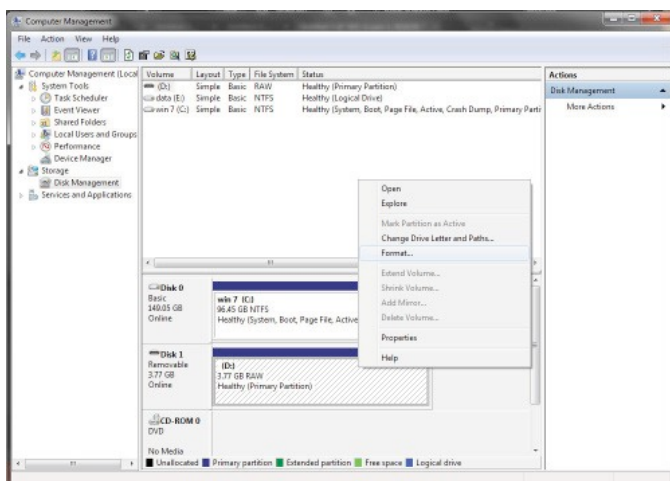

4. A janela **Formatar** irá se abrir.  
Digite uma nova **Etiqueta de Volume**.  
Selecione **FAT32** ou **NTFS** dependendo de suas necessidades e clique em **OK**.

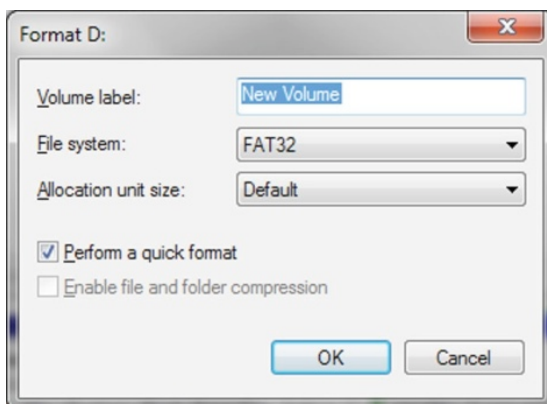

5. Clique em **OK** na janela de aviso **Formatar** para continuar a formatar a unidade.

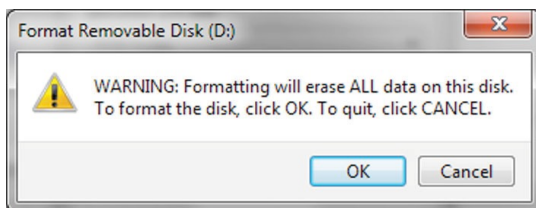

**Aviso:** Este procedimento irá excluir **todos os dados** armazenados na unidade.

6. O computador irá concluir a formatação e retornar à janela **Gerenciamento de Disco**.

Enquanto o DT2000 estiver sendo formatado, o LED **Azul** começará a piscar.

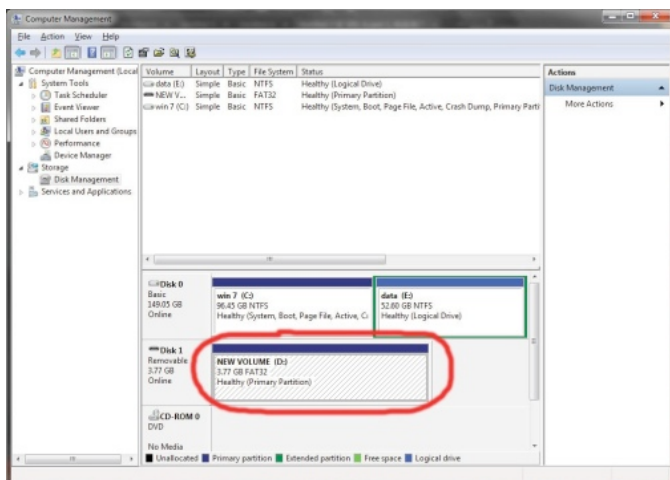

Quando concluído, o LED **Azul** torna-se sólido e seu DT2000 está pronto para usar.

## 14. Como configurar o DT2000 com o Sist. Operacional Mac

No caso da detecção de ataque de hacker tiver sido acionada inserindo-se o PIN incorreto 10 vezes sucessivas, ou se a unidade tiver sido reformatada, **todos os dados da unidade estarão perdidos para sempre**.

Depois que um novo **PIN de usuário** tiver sido criado, o DT2000 precisará ser inicializado e formatado.

Para formatar seu DT2000 em computadores com Sist. Operacional Mac, faça o seguinte:

1. Crie um novo **PIN de usuário** (consulte a seção 4).
2. Desbloqueie o DT2000 inserindo o novo **PIN de usuário** e conectando a uma porta USB de um computador Mac. O sistema irá exibir uma janela **INICIALIZAR**.

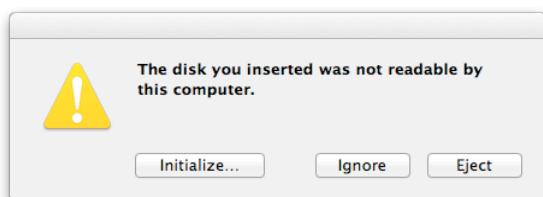

3. Pressione **INICIALIZAR** e selecione o DT2000 na janela **Utilitário de Disco**.

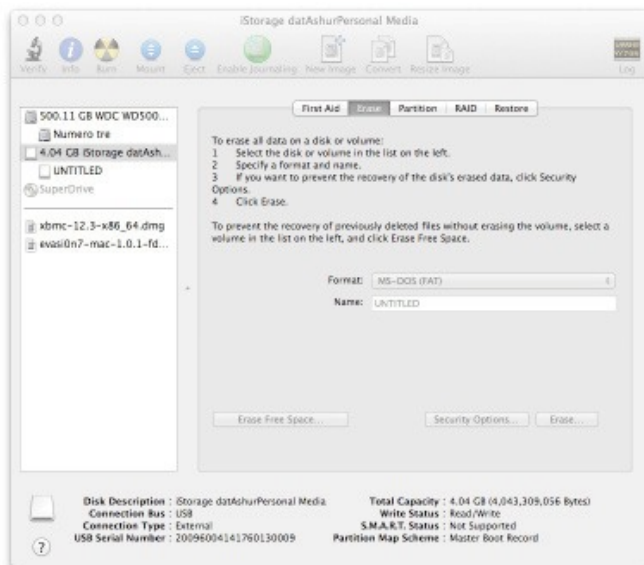

4. Clique no DT2000 do lado esquerdo da janela **Utilitário de Disco**.
5. Escolha **Apagar** no menu contextual no lado direito da janela. Selecione **MS-DOS** para **Formato do Volume**.
6. Clique em **Apagar**.

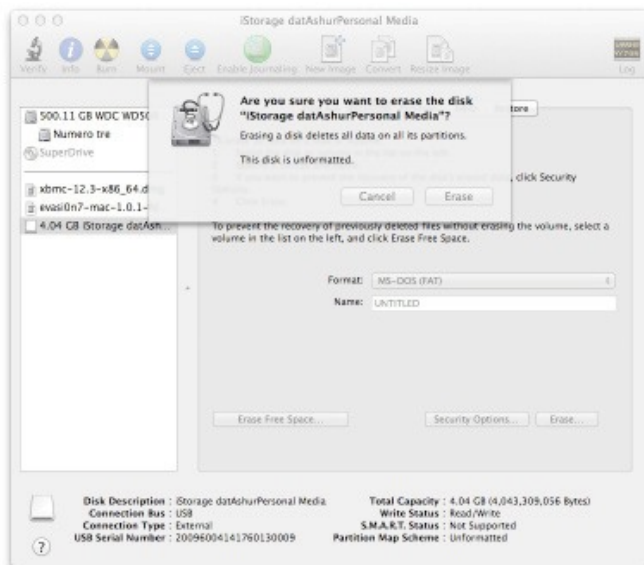

7. O DT2000 formatado irá aparecer na janela **Utilitário de Disco** e será criado no desktop.

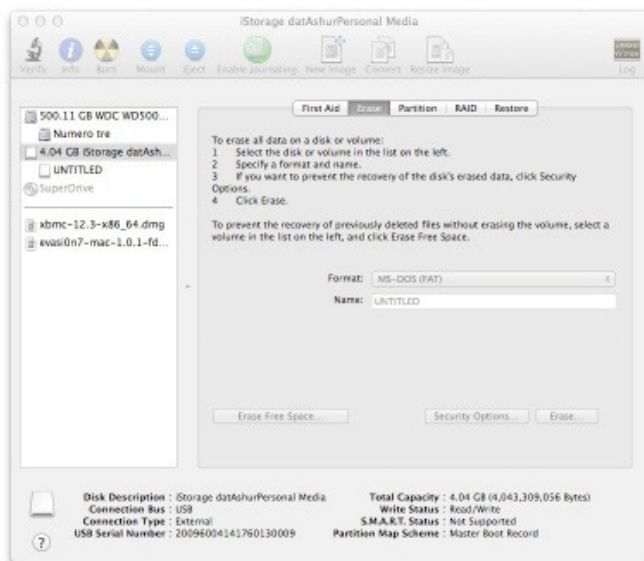

## Informações sobre a Bateria/Descarte do Produto

Não descarte seus produtos eletrônicos ou contendo bateria no seu lixo doméstico normal. Os produtos eletrônicos devem ser descartados de maneira responsável para minimizar o impacto no meio ambiente. Não tente remover a bateria do produto, ela só pode ser removida pela Kingston ou por um prestador de serviços profissional. Entre em [contato conosco](#) para mais informações sobre a bateria e como reciclar o produto de maneira responsável.

DataTraveler® 2000 incorpora a Tecnologia DataLock® licenciada pela ClevX, LLC.

## Instrukcja obsługi pamięci DataTraveler® 2000



**Kod PIN należy przechowywać w bezpiecznym miejscu. Jego utrata uniemożliwia dostęp do danych zapisanych w pamięci Kingston DataTraveler®.**

**W przypadku problemów należy zapoznać się z kompletną instrukcją obsługi umieszczoną w pamięci DT2000 oraz dostępną na stronie WWW firmy Kingston: [kingston.com/support](http://kingston.com/support)**

W pamięci DataTraveler® 2000 wykorzystano technologię DataLock® na licencji firmy ClevX, LLC.

©2016 Kingston Technology Europe Ltd i Digital Europe Ltd, Kingston Court, Brooklands Close, Sunbury-on-Thames, Middlesex, TW16 7EP, England. Tel: +44 (0) 1932 738888 Faks: +44 (0) 1932 785469. Wszelkie prawa zastrzeżone. Wszelkie znaki towarowe i zastrzeżone znaki towarowe są własnością odpowiednich właścicieli.





## Spis treści

Wymagania systemowe.....	3
Wprowadzenie.....	4
1. Elementy pamięci DT2000.....	5
2. Wskaźniki LED i ich znaczenie .....	5
3. Początkowe ustawienia pamięci DT2000 .....	6
4. Jak zmienić kod PIN .....	6
5. Jak aktywować opcje .....	7
6. Jak włączyć tryb tylko do odczytu.....	8
7. Jak włączyć tryb odczytu/zapisu .....	8
8. Jak ustawić limit czasu blokady .....	9
9. Jak wyłączyć limit czasu blokady.....	9
10. Jak sprawdzić numer wersji pamięci DT2000.....	10
11. Wykrywanie łamania hasła metodą brute force .....	10
12. Jak zresetować pamięć DT2000.....	11
13. Jak skonfigurować pamięć DT2000 w systemie operacyjnym Windows .....	12
14. Jak skonfigurować pamięć DT2000 w systemie operacyjnym Mac.....	15

## ***Informacje o tej Instrukcji obsługi***

Ta instrukcja obsługi dotyczy pamięci DataTraveler<sup>®</sup> 2000 (nazywanej odtąd w skrócie pamięcią DT2000).

### **Wymagania systemowe**

#### **Platforma PC**

#### **Obsługiwane systemy operacyjne komputerów PC**

- Windows 10
- Windows 8/8.1
- Windows 7
- Windows Vista<sup>®</sup> SP2

---

#### **Platforma Mac**

#### **Obsługiwane systemy operacyjne**

- Mac OS X 10.8.x – 10.11x

---

#### **Platforma Linux**

#### **Obsługiwane systemy operacyjne**

- Linux z wersją jądra 2.6+

---

#### **Inne platformy**

#### **Obsługiwane systemy operacyjne**

- Chrome OS<sup>™</sup>, Android\*

---

\* Tylko w kompatybilnych urządzeniach. Informacji na temat obsługi pamięci flash USB przez urządzenie udzieli jego producent.

## Wprowadzenie



**Uwaga:** Bateria pamięci DT2000 nie jest w pełni naładowana w chwili zakupu. Zalecamy pełne naładowanie baterii przed pierwszym użyciem. W tym celu należy podłączyć pamięć DT2000 do zasilanego portu USB i poczekać 60 minut na pełne naładowanie baterii.

Dziękujemy za zakup pamięci DataTraveler® 2000, wyjątkowo bezpiecznej i łatwej w użyciu, szyfrowanej sprzętowo pamięci flash USB 3.0 chronionej kodem PIN.



W pamięci DT2000 zastosowano 256-bitowe szyfrowanie sprzętowe XTS-AES klasy wojskowej, które szyfruje w czasie rzeczywistym wszystkie dane przechowywane w pamięci. Pamięć DT2000 nie wymaga żadnego zewnętrznego oprogramowania ani podłączania do specjalnych urządzeń.

Wbudowana klawiatura i bateria pamięci DT2000 umożliwiają użytkownikowi wprowadzenie kodu PIN złożonego z 7–15 cyfr przed podłączeniem pamięci do portu USB.

W przypadku zgubienia lub kradzieży pamięci użytkownik ma pewność, że wszystkie dane zapisane w pamięci DT2000 są bezpieczne i nie mogą zostać odczytane przez osoby niepowołane.

Do odblokowywania pamięci DT2000 służy wbudowana klawiatura a nie komputer, do którego podłączona zostaje pamięć. Pamięć jest odporna na programowe i sprzętowe aplikacje rejestrujące naciśnięcia klawiszy i ataki metodą brute force.









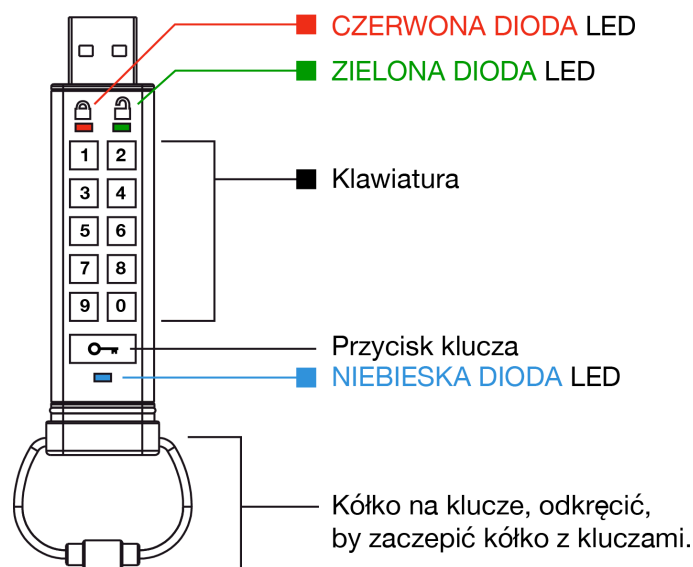







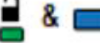

**Przeostroga:** W chwili zakupu domyślny kod PIN pamięci to  1-1-2-2-3-3-4-4  i można z niej od razu korzystać, używając tego domyślnego kodu PIN. Jednak ze względów bezpieczeństwa **zdecydowanie zalecamy bezzwłoczne utworzenie nowego kodu PIN**. Opis tej procedury zawiera rozdział 4 Jak zmienić kod PIN.

Użytkownik, który nie pamięta kodu PIN nie może uzyskać dostępu do danych w pamięci.

## 1. Elementy pamięci DT2000



## 2. Wskaźniki LED i ich znaczenie

Dioda LED	Stan diody LED	Opis	Stan diody LED	Opis	Opis
	<b>Czerwona</b> – ściemnianie do czarnego 	Blokowanie/wprowadzenie niepoprawnego kodu PIN		<b>Czerwona i zielona</b> – pulsowanie na przemian 	Reset do ustawień fabrycznych
	<b>Czerwona</b> – pulsowanie 	Pamięć zablokowana, oczekiwanie na domyślny kod PIN lub wprowadzenie zdefiniowanego kodu PIN			
	<b>Zielona</b> – świecenie bez przerw 	Pamięć DT2000 jest odblokowana		<b>Zielona i niebieska</b> – jednoczesne pulsowanie 	Tryb opcji użytkownika
	<b>Zielona</b> – pulsowanie 	Jeśli po podłączeniu pamięci DT2000 do portu USB <b>zielona</b> dioda LED pulsuje co 2 sekundy, oznacza to pracę w trybie tylko do odczytu			
	<b>Niebieska</b> – świecenie bez przerw 	Pamięć podłączono do portu USB			
	<b>Niebieska</b> – pulsowanie 	Wymiana danych z urządzeniem hostującym / zmiana kodu PIN			

### 3. Początkowe ustawienia pamięci DT2000

W chwili zakupu domyślny kod PIN pamięci to 11223344 i można z niej od razu korzystać, używając tego domyślnego kodu PIN. Jednak ze względów bezpieczeństwa zdecydowanie zalecamy bezzwłoczne utworzenie nowego kodu PIN. Opis tej procedury zawiera rozdział 4 Jak zmienić kod PIN.

3 proste czynności w poniższej tabeli umożliwiają odblokowanie pamięci DT2000 z użyciem domyślnego kodu PIN.

Instrukcje (pierwsze użycie)	Dioda LED	Stan diody LED
1. Naciśnij jednokrotnie przycisk klucza. 		<b>Czerwona</b> , <b>zielona</b> i <b>niebieska</b> diody LED zaświecą razem raz, a następnie zaczną pulsować <b>czerwona</b> dioda LED.
2. Wprowadź kod PIN w ciągu 10 sekund (domyślny – 11223344), aby odblokować pamięć DT2000.		<b>Czerwona</b> dioda LED nadal pulsuje.
3. Naciśnij jednokrotnie przycisk klucza. 		<b>Czerwona</b> dioda LED świecąca stale gaśnie, zaczyna stale świecić <b>zielona</b> dioda LED, potwierdzając poprawność wprowadzonego domyślnego kodu PIN.



**Uwaga:** Po pomyślnym odblokowaniu pamięci DT2000 **zielona** dioda LED świeci nieprzerwanie tylko przez 30 sekund. W tym czasie należy podłączyć pamięć DT2000 do portu USB. Pamięć można natychmiast zablokować ponownie, naciskając i przytrzymując przez 3 sekundy przycisk klucza  lub odczekując 30 sekund na automatyczne zablokowanie pamięci, lub klikając w systemie operacyjnym ikonę Bezpieczne usuwanie sprzętu i wysuwanie nośników.

### 4. Jak zmienić kod PIN

Kod PIN musi spełniać następujące warunki:













- długość od 7 do 15 cyfr;
- nie może składać się wyłącznie z powtarzających się cyfr, np. 3-3-3-3-3-3;
- nie może składać się wyłącznie z kolejnych cyfr, np. 1-2-3-4-5-6-7, 7-8-9-0-1-2-3-4, 7-6-5-4-3-2-1.

**Wskazówka dotycząca tworzenia hasła:** Można utworzyć łatwe do zapamiętania słowo, nazwę, frazę lub inny alfanumeryczny kod PIN, naciskając klawisze z literami odpowiadającymi literom w hasle.

Oto kilka przykładów tego typu alfanumerycznych kodów PIN:

- Słowu „**password**” odpowiada następująca sekwencja klawiszy:  
7 (pqr**s**) 2 (a**bc**) 7 (pqr**s**) 7 (pqr**s**) 9 (w**xyz**) 6 (m**no**) 7 (pqr**s**) 3 (d**ef**)
- Słowu „**kingston**” odpowiada następująca sekwencja:  
5 (j**kl**) 4 (g**hi**) 6 (m**no**) 4 (g**hi**) 7 (pqr**s**) 8 (t**uv**) 6 (m**no**) 6 (m**no**)

Dzięki tej metodzie można tworzyć długie, ale łatwe do zapamiętania kody PIN.







Instrukcje	Dioda LED	Stan diody LED
1. Naciśnij jednokrotnie przycisk klucza. 		<b>Czerwona, zielona i niebieska</b> diody LED zaświecą razem raz, a następnie zaczną pulsować <b>czerwona</b> dioda LED.
2. Zaczynaj wprowadzać kod PIN w ciągu 10 sekund (domyślny – 11223344), aby odblokować pamięć DT2000.		<b>Czerwona</b> dioda LED nadal pulsuje.
3. Naciśnij jednokrotnie przycisk klucza. 		<b>Czerwona</b> dioda LED świecąca stale gaśnie, zaczyna stale świecić <b>zielona</b> dioda LED, potwierdzając poprawność wprowadzonego domyślnego kodu PIN.
4. Naciśnij dwukrotnie przycisk klucza. 		<b>Niebieska</b> dioda LED pulsuje.
5. Zaczynaj wprowadzać nowy kod PIN w ciągu 10 sekund.		<b>Niebieska</b> dioda LED nadal pulsuje.
6. Naciśnij dwukrotnie przycisk klucza. 		<b>Zielona</b> dioda LED pulsuje.
7. Zaczynaj ponownie wprowadzać nowy kod PIN w ciągu 10 sekund.		<b>Zielona</b> dioda LED nadal pulsuje.
8. Naciśnij dwukrotnie przycisk klucza. 		<b>Czerwona</b> dioda LED świecąca stale gaśnie, zaczyna stale świecić <b>zielona</b> dioda LED, potwierdzając pomyślną zmianę kodu PIN.



**Uwaga:** Jeśli podczas definiowania nowego kodu PIN zostanie popełniona pomyłka lub jeśli procedura nie zostanie zakończona, pamięć będzie nadal chroniona starym kodem PIN.



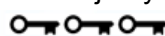

## 5. Jak aktywować opcje

Tryb opcji umożliwia korzystanie z różnych funkcji, takich jak włączanie i wyłączenie w pamięci DT2000 trybu tylko do odczytu, ustawianie limitu czasu automatycznej blokady i sprawdzanie wersji urządzenia. Poniższa tabela ilustruje sposób uzyskiwania dostępu do trybu opcji. Rozdziały 6-9 opisują sposoby korzystania z różnych funkcji.

Instrukcje	Dioda LED	Stan diody LED
1. Naciśnij jednokrotnie przycisk klucza. 		<b>Czerwona, zielona i niebieska</b> diody LED zaświecą razem raz, a następnie zaczną pulsować <b>czerwona</b> dioda LED.
2. Wprowadź kod PIN w ciągu 10 sekund (domyślny – 11223344), aby odblokować pamięć DT2000.		<b>Czerwona</b> dioda LED nadal pulsuje.
3. Naciśnij jednokrotnie przycisk klucza. 		<b>Czerwona</b> dioda LED świecąca stale gaśnie, zaczyna stale świecić <b>zielona</b> dioda LED, potwierdzając poprawność wprowadzonego kodu PIN.
4. Naciśnij trzykrotnie przycisk klucza. 		<b>Zielona i niebieska</b> diody pulsują jednocześnie, wskazując oczekiwanie na nowe instrukcje trybu opcji.

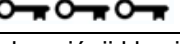
## 6. Jak włączyć tryb tylko do odczytu

Pamięć DT2000 udostępnia tryb tylko do odczytu, uniemożliwiający zapisywanie w niej danych. Procedurę włączania tego trybu opisano poniżej.

Instrukcje	Dioda LED	Stan diody LED
1. Odblokuj pamięć DT2000, wprowadzając kod PIN.		<b>Czerwona</b> dioda LED świecąca stale gaśnie, zaczyna stale świecić <b>zielona</b> dioda LED, potwierdzając poprawność wprowadzonego kodu PIN.
2. Włącz tryb opcji, naciskając trzykrotnie przycisk klucza. 		<b>Zielona</b> i <b>niebieska</b> diody pulsują jednocześnie, wskazując oczekiwanie na nowe instrukcje trybu opcji.
3. W ciągu 10 sekund naciśnij klawisz 7 ( <b>pqrs</b> ), a następnie klawisz 6 ( <b>mno</b> ) (ang. Read Only) (76).		<b>Zielona</b> i <b>niebieska</b> diody nadal pulsują jednocześnie.
4. Naciśnij jednokrotnie przycisk klucza. 		<b>Niebieska</b> dioda LED szybko przygasa, zaczyna stale świecić <b>zielona</b> dioda LED – po podłączeniu pamięci DT2000 do portu USB <b>zielona</b> dioda LED pulsuje co dwie sekundy, wskazując, że pamięć pracuje w trybie tylko do odczytu.

Po zakończeniu tej procedury możliwe jest tylko odczytywanie danych do chwili wyłączenia ochrony przed zapisem.



**Uwaga:** Zastosowana konwencja (użycie pierwszych liter terminu w języku angielskim) ułatwia zapamiętanie sekwencji klawiszy włączających poszczególne opcje. W powyższej procedurze wykorzystano klawisze cyfr odpowiadające literom R i O – **Read-Only** = 7 (pqrs) 6 (mno).

## 7. Jak włączyć tryb odczytu/zapisu

Ochronę przed zapisem (tryb tylko do odczytu) można wyłączyć i przywrócić możliwość odczytywania i zapisywania danych. Procedurę włączania tego trybu opisano poniżej.

Instrukcje	Dioda LED	Stan diody LED
1. Odblokuj pamięć DT2000, wprowadzając kod PIN.		<b>Czerwona</b> dioda LED świecąca stale gaśnie, zaczyna stale świecić <b>zielona</b> dioda LED, potwierdzając poprawność wprowadzonego kodu PIN.
2. Włącz tryb opcji, naciskając trzykrotnie przycisk klucza. 		<b>Zielona</b> i <b>niebieska</b> diody pulsują jednocześnie, wskazując oczekiwanie na nowe instrukcje trybu opcji.
3. W ciągu 10 sekund naciśnij klawisz 7 ( <b>pqrs</b> ), a następnie klawisz 9 ( <b>wxyz</b> ) (ang. Read Write)(79).		<b>Zielona</b> i <b>niebieska</b> diody nadal pulsują jednocześnie.
4. Naciśnij jednokrotnie przycisk klucza. 		<b>Niebieska</b> dioda LED szybko przygasa, zaczyna stale świecić <b>zielona</b> dioda LED – po podłączeniu pamięci DT2000 do portu USB <b>zielona</b> dioda LED pulsuje co dwie sekundy, wskazując, że pamięć pracuje w trybie odczytu/zapisu.



Po zakończeniu tej procedury możliwe jest odczytywanie i zapisywanie danych.

## 8. Jak ustawić limit czasu blokady

Aby chronić pozostawioną bez nadzoru pamięć DT2000 podłączoną do urządzenia hostującego przed dostępem niepowołanych osób, można włączyć funkcję automatycznej blokady po upływie zadanego czasu.

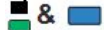

Domyślnie funkcja ta jest wyłączona. Okres, po którym pamięć będzie się automatycznie blokować można ustawić na wartość z zakresu od 1 minuty do 99 minut.

Aby ustawić limit czasu blokady, wykonaj czynności w poniższej tabeli.

Instrukcje	Dioda LED	Stan diody LED
1. Odblokuj pamięć DT2000, wprowadzając kod PIN.		<b>Czerwona</b> dioda LED świecąca stale gaśnie, zaczyna stale świecić <b>zielona</b> dioda LED, potwierdzając poprawność wprowadzonego kodu PIN.
2. Włącz tryb opcji, naciskając trzykrotnie przycisk klucza. 		<b>Zielona</b> i <b>niebieska</b> diody pulsują jednocześnie, wskazując oczekiwanie na nowe instrukcje trybu opcji.
3. W ciągu 10 sekund naciśnij klawisz <b>8</b> (tuv), a następnie klawisz <b>5</b> (jkl) (ang. Timeout Lock) ( <b>85</b> ).		<b>Zielona</b> i <b>niebieska</b> diody nadal pulsują jednocześnie.
4. Naciśnij jednokrotnie przycisk klucza. 		<b>Zielona</b> dioda LED pulsuje.
5. W ciągu 10 sekund określ limit czasu, wyrażony dwoma cyframi: 00 = 0 minut (ustawienie domyślne) 01 = 1 minuta 99 = 99 minut itp.		<b>Zielona</b> dioda LED nadal pulsuje.
6. Naciśnij jednokrotnie przycisk klucza. 		<b>Zielona</b> dioda LED świeci nieprzerwanie – pomyślnie włączono limit czasu blokady.







## 9. Jak wyłączyć limit czasu blokady

Aby wyłączyć limit czasu blokady, wykonaj czynności w poniższej tabeli.

Instrukcje	Dioda LED	Stan diody LED
1. Odblokuj pamięć DT2000, wprowadzając kod PIN.		<b>Czerwona</b> dioda LED świecąca stale gaśnie, zaczyna stale świecić <b>zielona</b> dioda LED, potwierdzając poprawność wprowadzonego kodu PIN.
2. Włącz tryb opcji, naciskając trzykrotnie przycisk klucza. 		<b>Zielona</b> i <b>niebieska</b> diody pulsują jednocześnie, wskazując oczekiwanie na nowe instrukcje trybu opcji.
3. W ciągu 10 sekund naciśnij klawisz <b>8</b> (tuv), a następnie klawisz <b>5</b> (jkl) (ang. Timeout Lock) ( <b>85</b> ).		<b>Zielona</b> i <b>niebieska</b> diody nadal pulsują jednocześnie.
4. Naciśnij jednokrotnie przycisk klucza. 		<b>Zielona</b> dioda LED pulsuje.
5. W ciągu 10 sekund naciśnij dwukrotnie klawisz <b>0</b> (zero zero) – ( <b>00</b> minut).		<b>Zielona</b> dioda LED nadal pulsuje.
6. Naciśnij jednokrotnie przycisk klucza. 		<b>Zielona</b> dioda LED świeci nieprzerwanie – pomyślnie wyłączono limit czasu blokady.



## 10. Jak sprawdzić numer wersji pamięci DT2000

Instrukcje	Dioda LED	Stan diody LED
1. Odblokuj pamięć DT2000, wprowadzając kod PIN.		<b>Czerwona</b> dioda LED świecąca stale gaśnie, zaczyna stale świecić <b>zielona</b> dioda LED, potwierdzając poprawność wprowadzonego kodu PIN.
2. Włącz tryb opcji, naciskając trzykrotnie przycisk klucza. 		<b>Zielona</b> i <b>niebieska</b> diody pulsują jednocześnie, wskazując oczekiwanie na nowe instrukcje trybu opcji.
3. W ciągu 10 sekund naciśnij klawisz <b>8</b> (tuv), a następnie klawisz <b>6</b> (mno) (ang. Version Number) ( <b>86</b> ).		<b>Zielona</b> i <b>niebieska</b> diody nadal pulsują jednocześnie.
4. Naciśnij jednokrotnie przycisk klucza. 	 	<b>Czerwona</b> , <b>zielona</b> i <b>niebieska</b> diody LED zaświecą krótko razem, a następnie <b>czerwona</b> dioda LED zaświeci się liczbę razy odpowiadającą pierwszej znaczącej cyfrze numeru wersji, potem <b>zielona</b> dioda LED wskaże drugą znaczącą cyfrę numeru wersji w analogiczny sposób.
Na przykład, jeśli numer wersji to 1.8, <b>czerwona</b> dioda LED zapala się jeden (1) raz, a <b>zielona</b> dioda LED zapala się osiem (8) razy. Po wskazaniu numeru wersji <b>czerwona</b> , <b>zielona</b> i <b>niebieska</b> diody LED zaświecą krótko razem, a następnie <b>zielona</b> dioda LED zacznie świecić stale.		

## 11. Wykrywanie łamania hasła metodą brute force



**Przeostoga:** Wprowadzenie nieprawidłowego kodu PIN 10 (dziesięć) kolejnych razy powoduje aktywowanie mechanizmu ochrony pamięci DT2000 przed atakami metodą brute force i bezpowrotne usunięcie kodu PIN, klucza szyfrowania i **wszystkich danych**.

Kod PIN odblokowujący pamięć DT2000	Co się stanie po 10 kolejnych próbach wprowadzenie nieprawidłowego kodu PIN?
Kod PIN	Aktywowanie mechanizmu ochrony pamięci DT2000 przed atakami metodą brute force i bezpowrotne usunięcie kodu PIN, klucza szyfrowania i wszystkich danych.

Wprowadzenie nieprawidłowego kodu PIN 10 (dziesięć) kolejnych razy powoduje bezpowrotne usunięcie klucza szyfrowania i wszystkich danych. Następnie przywracane są domyślne ustawienia pamięci DT2000, czyli fabryczny kod PIN – 11223344. Sposób zmiany kodu PIN opisuje rozdział 4 na stronie 6. Ponadto w takiej sytuacji wymuszane jest utworzenie nowego klucza szyfrowania, co powoduje konieczność ponownego sformatowania pamięci DT2000 (patrz rozdział 13 lub 14).

Cechą wyróżniającą pamięć DT2000 wśród innych urządzeń tego typu jest wyposażenie jej w generator liczb losowych. Po zresetowaniu pamięci nowy klucz szyfrowania zostaje wygenerowany losowo.









## 12. Jak zresetować pamięć DT2000

Poniżej opisano czynności do wykonania, jeśli użytkownik nie pamięta kodu PIN lub chce usunąć wszystkie dane zapisane w pamięci DT2000.

W ramach procesu resetowania wymazywane są wszystkie parametry kryptograficzne, z kodem PIN włącznie. Oznacza to, że przywrócone zostają domyślne ustawienia pamięci DT2000, czyli fabryczny kod PIN – 11223344. Sposób zmiany kodu PIN opisuje rozdział 4 na stronie 6. Ponadto w takiej sytuacji wymuszane jest utworzenie nowego klucza szyfrowania, co powoduje konieczność ponownego sformatowania pamięci DT2000 (patrz rozdział 13 lub 14).



**Przeostroga:** Zresetowanie pamięci DT2000 spowoduje usunięcie **wszystkich danych** zapisanych w pamięci.

Instrukcje	Dioda LED	Stan diody LED
1. Naciśnij i przytrzymaj klawisz <b>7</b> (pqrs), a następnie przycisk klucza  . Puść oba przyciski ( <b>7</b> i  ).	 / 	<b>Czerwona</b> i <b>zielona</b> diody LED pulsują na przemian.
2. W ciągu 10 sekund naciśnij trzykrotnie klawisz <b>9</b> (wxyz) ( <b>999</b> ).	 / 	<b>Czerwona</b> i <b>zielona</b> diody LED nadal pulsują na przemian.
3. Naciśnij i przytrzymaj klawisz <b>7</b> (pqrs), a następnie przycisk klucza  . Puść oba przyciski ( <b>7</b> i  ).		<b>Czerwona</b> dioda LED ciemnieje, wskazując zakończenie procesu.

## 13. Jak skonfigurować pamięć DT2000 w systemie operacyjnym Windows

W przypadku aktywowania ochrony przed próbą włamania w wyniku **wprowadzenia niepoprawnego kodu PIN 10 kolejnych razy** lub zresetowania pamięci **wszystkie dane zapisane w pamięci zostają bezpowrotnie utracone**.

Po utworzeniu nowego  **kodu PIN** należy zainicjować i sformatować pamięć DT2000.

**Aby zainicjować pamięć DT2000, wykonaj następujące czynności:**

1. Utwórz nowy  **kod PIN** (patrz rozdział 4).
2. Odblokuj pamięć DT2000, wprowadzając nowy  **kod PIN** i podłącz ją do portu USB komputera.
3. Komputer powinien wyświetlić następujący komunikat:

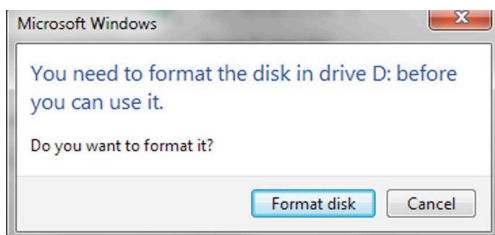

4. Aby kontynuować, kliknij przycisk **Formatuj dysk**. Wybierz opcję **FAT32** lub **NTFS** w zależności od potrzeb, wprowadź **Etykietę woluminu** i kliknij **Start**.

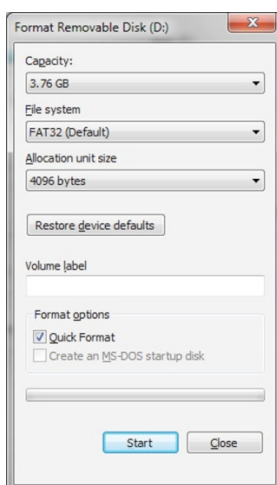

5. Kliknij **OK**, aby rozpocząć formatowanie pamięci.

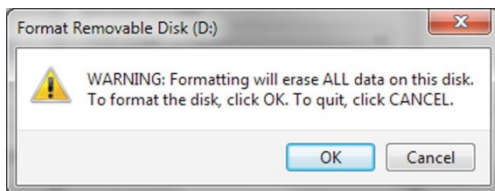

**Ostrzeżenie:** Ta procedura spowoduje usunięcie **wszystkich danych** zapisanych w pamięci.

6. Komputer formatuje pamięć i informuje o zakończeniu procedury. Podczas formatowania pamięci DT2000 pulsuje **niebieska** dioda LED.

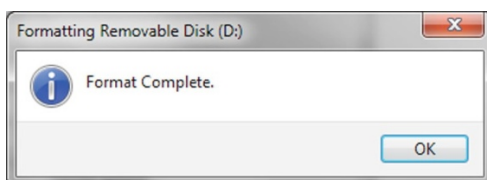

Po zakończeniu **niebieska** dioda zaczyna świecić bez przerwy, a pamięć DT2000 jest gotowa do użycia.

**Jeśli kreator formatowania nie zostanie wyświetlony, wykonaj poniższe czynności:**

1. Kliknij ikonę **Mój komputer** lub **Komputer** prawym przyciskiem myszy i wybierz polecenie **Zarządzaj**.
2. W oknie **Zarządzanie komputerem**, na karcie **Zarządzanie dyskami** pamięć DT2000 widnieje jako urządzenie wymienne w formacie nieprzetworzonym.

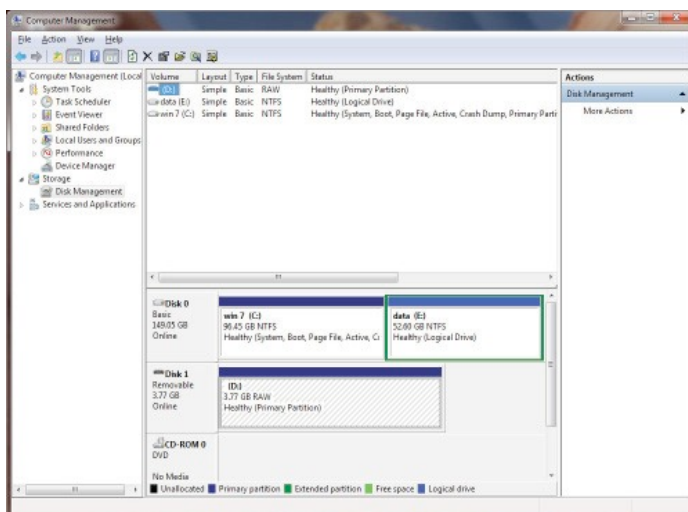

3. W pustym obszarze w sekcji Nieprzydzielone kliknij prawym przyciskiem myszy pozycję **Removable Raw Drive** i wybierz polecenie **Formatuj**.

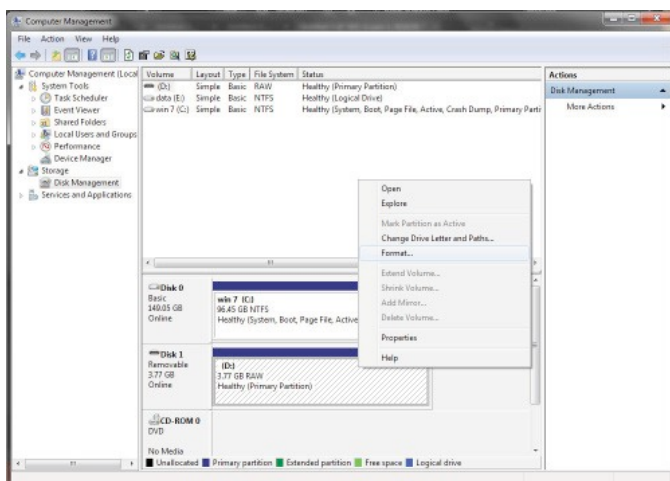

4. Zostanie otworzone okno **Formatuj**.  
Wprowadź nową **Etykietę woluminu**.  
Wybierz opcję **FAT32** lub **NTFS** w zależności od potrzeb i kliknij **OK**.

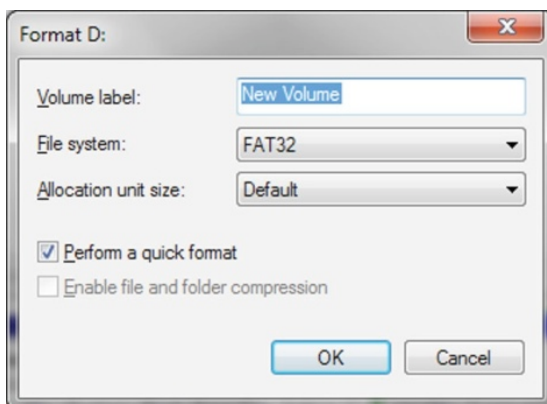

5. Kliknij **OK** w oknie ostrzeżenia o **formatowaniu**, aby rozpocząć formatowanie pamięci.

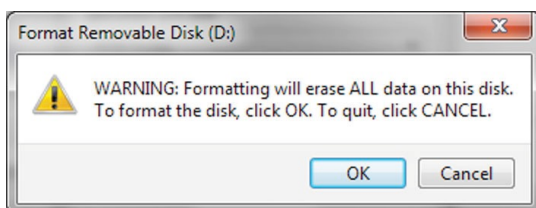

**Ostrzeżenie:** Ta procedura spowoduje usunięcie **wszystkich danych** zapisanych w pamięci.

6. Po sformatowaniu pamięci przez komputer nastąpi powrót do okna **Zarządzanie dyskami**.

Podczas formatowania pamięci DT2000 pulsuje **niebieska** dioda LED.

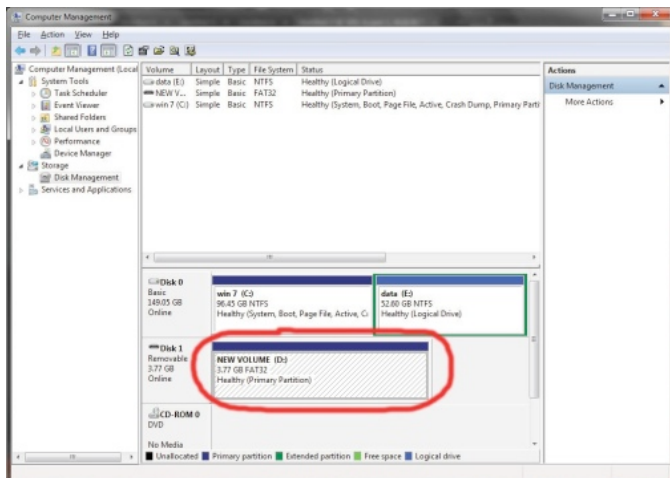

Po zakończeniu **niebieska** dioda zaczyna świecić bez przerwy, a pamięć DT2000 jest gotowa do użycia.

## 14. Jak skonfigurować pamięć DT2000 w systemie operacyjnym Mac

W przypadku aktywowania ochrony przed próbą włamania w wyniku wprowadzenia niepoprawnego kodu PIN 10 kolejnych razy lub zresetowania pamięci **wszystkie dane zapisane w pamięci zostają bezpowrotnie utracone**.

Po utworzeniu nowego **kodu PIN** należy zainicjować i sformatować pamięć DT2000.

Aby sformatować pamięć DT2000 w systemie operacyjnym Mac, należy wykonać następujące czynności:

1. Utwórz nowy **kod PIN** (patrz rozdział 4).
2. Odblokuj pamięć DT2000, wprowadzając nowy **kod PIN** i podłącz ją do portu USB komputera Mac. System wyświetli okno **inicjacji**.



3. Naciśnij przycisk **Inicjuj**, a w oknie **Narzędzia dyskowe** wybierz pamięć DT2000.

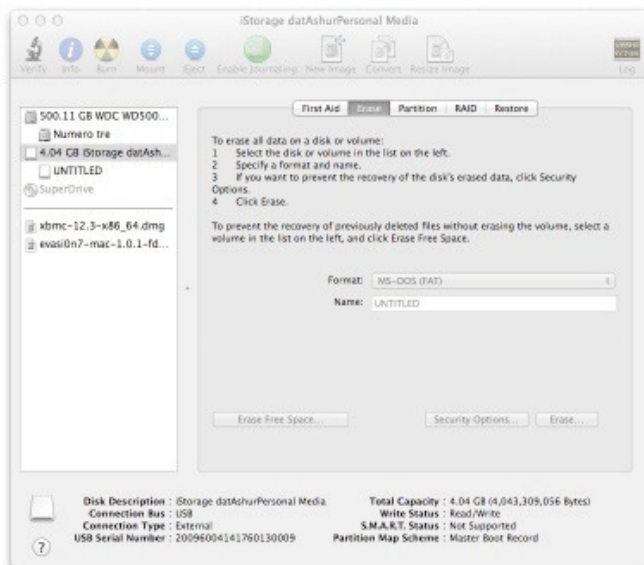

4. Kliknij pamięć DT2000 po lewej stronie okna **Narzędzia dyskowe**.
5. Kliknij kartę **Wymaż** po prawej stronie ekranu. Wybierz **MS-DOS** jako **Format woluminu**.
6. Kliknij przycisk **Wymaż**.

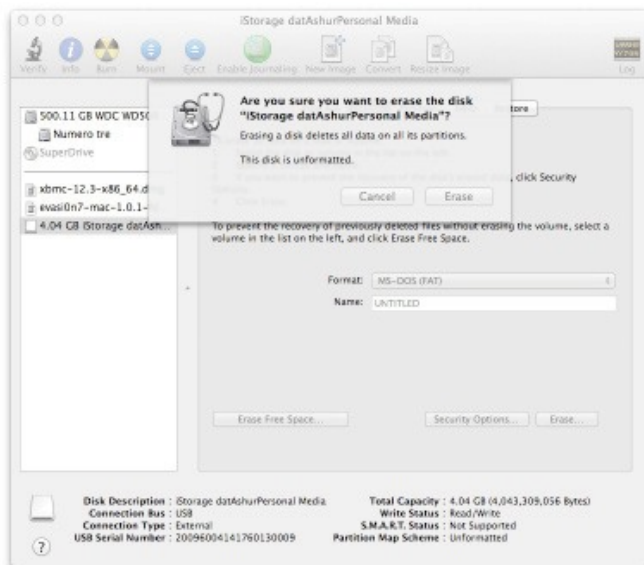

7. Sformatowana pamięć DT2000 zostanie wyświetlona w oknie **Narzędzia dyskowe** i na pulpicie.

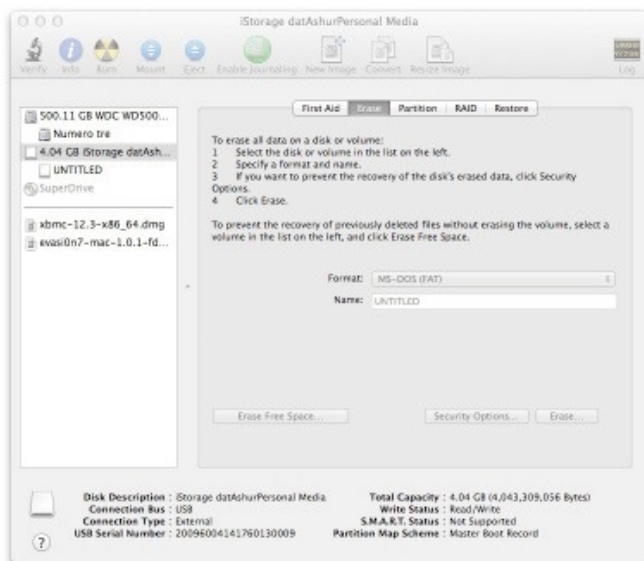

## Informacje o baterii i utylizacji produktu

Produktów elektrycznych i zawierających baterie nie należy wyrzucać ze zwykłymi odpadami domowymi. Produkty elektroniczne należy utylizować zgodnie z przepisami w celu ograniczenia szkodliwości dla środowiska. Nie należy samodzielnie wyjmować baterii z produktu — może to zrobić tylko firma Kingston lub profesjonalny usługodawca. Aby uzyskać więcej informacji na temat baterii i odpowiedzialnej utylizacji produktu, zachęcamy do kontaktu z nami.

W pamięci DataTraveler<sup>®</sup> 2000 wykorzystano technologię DataLock<sup>®</sup> na licencji firmy ClevX, LLC.



## USB-накопитель DataTraveler® 2000 - Руководство пользователя



**Храните свой PIN-код в надежном месте. Если вы забудете или потеряете его, доступ к данным, хранящимся на накопителе Kingston DataTraveler®, будет невозможен.**

При возникновении каких-либо вопросов обратитесь к данному полному руководству пользователя, которое загружено на накопитель. Документ также доступен на веб-сайте Kingston: [kingston.com/support](http://kingston.com/support)

В USB-накопителе DataTraveler® 2000 используется технология DataLock® компании ClevX, LLC.

©2016 Kingston Technology Corporation, 17600 Newhope Street, Fountain Valley, CA 92708 USA. Все права защищены. Все товарные знаки и зарегистрированные товарные знаки являются собственностью соответствующих владельцев.



## Оглавление

О РУКОВОДСТВЕ .....	3
ВВЕДЕНИЕ .....	4
1. ВНЕШНИЙ ВИД USB-НАКОПИТЕЛЯ DT2000 .....	5
2. СВЕТОДИОДНЫЕ ИНДИКАТОРЫ И ИХ ЗНАЧЕНИЕ .....	5
3. НАЧАЛО РАБОТЫ С USB-НАКОПИТЕЛЕМ DT2000 .....	6
4. ИЗМЕНЕНИЕ ПОЛЬЗОВАТЕЛЬСКОГО PIN-КОДА.....	6
5. ВКЛЮЧЕНИЕ ОПЦИЙ.....	7
6. ВКЛЮЧЕНИЕ РЕЖИМА «ТОЛЬКО ДЛЯ ЧТЕНИЯ» .....	8
7. ВКЛЮЧЕНИЕ РЕЖИМА ЧТЕНИЯ И ЗАПИСИ .....	8
8. УСТАНОВКА РЕЖИМА БЛОКИРОВКИ ПО ВРЕМЕНИ .....	9
9. ОТКЛЮЧЕНИЕ РЕЖИМА БЛОКИРОВКИ ПО ВРЕМЕНИ .....	9
10. ОПРЕДЕЛЕНИЕ НОМЕРА ВЕРСИИ USB-НАКОПИТЕЛЯ DT2000.....	10
11. РАСПОЗНАВАНИЕ ВЗЛОМА МЕТОДОМ ПЕРЕБОРА.....	10
12. ВЫПОЛНЕНИЕ СБРОСА USB-НАКОПИТЕЛЯ DT2000 .....	11
13. НАСТРОЙКА USB-НАКОПИТЕЛЯ DT2000 ДЛЯ РАБОТЫ С ОС WINDOWS .....	12
14. НАСТРОЙКА USB-НАКОПИТЕЛЯ DT2000 ДЛЯ РАБОТЫ С MAC OS.....	15



## О руководстве

Данное руководство пользователя относится к USB-накопителю DataTraveler® 2000 Kingston (далее - DT2000).

## Системные требования

---

### Платформа ПК

### Поддерживаемые операционные системы ПК

- Windows 10
- Windows 8/8.1
- Windows 7
- Windows Vista® SP2

---

### Платформа Mac

### Поддержка операционных систем

- Mac OS X 10.8.x - 10.11x

---

### Платформа Linux

### Поддержка операционных систем

- Ядро Linux версии 2.6 и выше

---

### Другие платформы

### Поддержка операционных систем

- Chrome OS™, Android\*

---

\*Только совместимые устройства. Проверьте у производителя устройства, поддерживает ли оно USB-накопители.

## ВВЕДЕНИЕ



**Примечание:** перезаряжаемый аккумулятор USB-накопителя DT2000 при поставке заряжен не полностью. Рекомендуем зарядить аккумулятор перед началом работы. Для этого подключите DT2000 к порту USB на 1 час, чтобы полностью зарядить аккумулятор.

Благодарим вас за приобретение USB-накопителя DataTraveler® 2000, надежного и простого в использовании накопителя с интерфейсом USB 3.0 и с функцией аппаратного шифрования и активации PIN-кодом.

В DT2000 используется 256-битное аппаратное шифрование XTS-AES военного уровня, которое в реальном времени шифрует все данные, записываемые на накопитель. USB-накопитель DT2000 не требует дополнительного ПО и не зависит от ОС и хост-устройства.

USB-накопитель DT2000 имеет перезаряжаемый аккумулятор, который позволяет пользователю ввести на встроенной клавиатуре PIN-код (персональный идентификационный номер) длиной 7-15 цифр перед подключением накопителя к порту USB.

В случае утери или кражи накопителя пользователь может быть уверен, что все данные, хранящиеся на нем, надежно защищены и не могут быть использованы посторонними лицами.

USB-накопитель DT2000 разблокируется с помощью встроенной клавиатуры, а не компьютера. Накопитель защищен от программных и аппаратных перехватчиков вводимой информации и атак методом перебора.



**Внимание:** DT2000 поставляется с настроенным по  1-1-2-2-3-3-4-4 







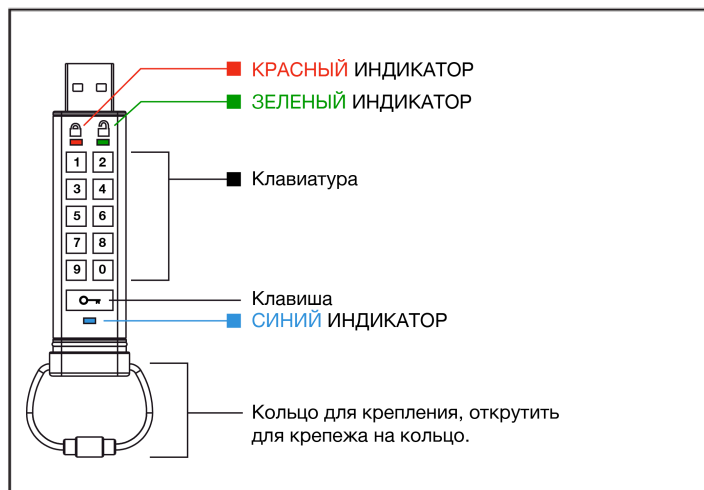





и несмотря на то, что накопитель можно использовать сразу после покупки с PIN-кодом по умолчанию, из соображений безопасности мы **настоятельно рекомендуем сразу же создать новый пользовательский PIN-код**; см. инструкции в разделе 4 «Изменение пользовательского PIN-кода».

Если вы забудете PIN-код, все данные будут недоступны.

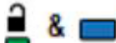
## 1. Внешний вид USB-накопителя DT2000



## 2. Светодиодные индикаторы и их значение

Индикатор	Состояние индикатора	Описание	Состояние индикатора	Описание	Описание
	<b>Красный Черный</b> отключение 	Выполняется блокировка/введен неправильный PIN-код		<b>Красный и зеленый</b> загораются попеременно 	Сброс на заводские настройки
	<b>Красный</b> мигает 	Заблокирован, ожидается ввод заводского PIN-кода по умолчанию или установленного PIN-кода			
	<b>Зеленый</b> горит постоянно 	Накопитель разблокирован		<b>Зеленый и синий</b> мигают вместе 	Режим пользовательских опций
	<b>Зеленый</b> мигает 	При подключении к порту USB, если <b>зеленый</b> индикатор мигает каждые 2 секунды, это означает, что DT2000 переведен в режим «только для чтения»			
	<b>Синий</b> горит постоянно 	Подключен к порту USB			
	<b>Синий</b> мигает	Обмен данными с хост-устройством/изменение пользовательского PIN-кода			

### 3. Начало работы с USB-накопителем DT2000

USB-накопитель DT2000 поставляется с настроенным по умолчанию PIN-кодом 11223344 и несмотря на то, что накопитель можно использовать сразу после покупки с PIN-кодом по умолчанию, из соображений безопасности мы настоятельно рекомендуем сразу же создать новый пользовательский PIN-код; см. инструкции в разделе 4 'Изменение пользовательского PIN-кода'.

Выполните 3 действия из таблицы ниже для разблокировки USB-накопителя DT2000 с PIN-кодом по умолчанию.

Инструкции (первое использование)	Индикатор	Состояние индикатора
1. Нажмите один раз кнопку KEY 		<b>Красный, зеленый и синий</b> индикаторы одновременно загорятся, а затем <b>красный</b> индикатор продолжит мигать
2. В течение 10 секунд введите пользовательский PIN-код (по умолчанию - 11223344) для разблокировки USB-накопителя DT2000		<b>Красный</b> индикатор продолжит мигать
3. Нажмите один раз кнопку KEY 		<b>Красный</b> постоянно горящий индикатор сменится на <b>зеленый</b> постоянно горящий индикатор, сигнализируя о правильном вводе пользовательского PIN-кода по умолчанию



**Примечание:** После разблокировки DT2000 **зеленый** индикатор будет продолжать постоянно гореть только в течение 30 секунд; за это время необходимо подключить DT2000 к порту USB. Накопитель можно мгновенно заблокировать, нажав и удерживая кнопку KEY  в течение 3 секунд, или подождав 30 секунд, или нажав на значок 'Безопасное извлечение устройства' в операционной системе.

### 4. Изменение пользовательского PIN-кода

Требования к PIN-коду:













- Длина 7-15 цифр
- Не должен содержать только повторяющиеся цифры, например (3-3-3-3-3-3)
- Не должен содержать только последовательные цифры, например (1-2-3-4-5-6-7), (7-8-9-0-1-2-3-4), (7-6-5-4-3-2-1)

**Подсказка пароля:** Можно создать запоминаемое слово, имя, фразу или любую алфавитно-цифровую комбинацию для PIN-кода, нажимая клавиши с

Примеры таких алфавитно-цифровых PIN-кодов:

- Для ввода «**password**» нужно нажать следующие клавиши:  
7 (pqrs) 2 (abc) 7 (pqrs) 7 (pqrs) 9 (wxyz) 6 (mno) 7 (pqrs) 3 (def)
- Для ввода «**kingston**» нужно нажать:  
5 (jkl) 4 (ghi) 6 (mno) 4 (ghi) 7 (pqrs) 8 (tuv) 6 (mno) 6 (mno)

Таким образом можно создать длинный и простой в запоминании PIN-код.

Инструкции	Индикатор	Состояние индикатора
1. Нажмите один раз кнопку KEY 		<b>Красный</b> , <b>зеленый</b> и <b>синий</b> индикаторы одновременно загорятся, а затем <b>красный</b> индикатор продолжит мигать
2. В течение 10 секунд начните вводить пользовательский PIN-код (по умолчанию - 11223344) для разблокировки DT2000		<b>Красный</b> индикатор продолжит мигать
3. Нажмите один раз кнопку KEY 		<b>Красный</b> постоянно горящий индикатор сменится на <b>зеленый</b> постоянно горящий индикатор, сигнализируя о правильном вводе пользовательского PIN-кода по умолчанию
4. Дважды нажмите кнопку KEY (двойной щелчок) 		<b>Синий</b> индикатор замигает
5. В течение 10 секунд начните вводить новый пользовательский PIN-код		<b>Синий</b> индикатор продолжает мигать
6. Дважды нажмите кнопку KEY (двойной щелчок) 		<b>Зеленый</b> индикатор замигает
7. В течение 10 секунд начните повторно вводить новый пользовательский PIN-код		<b>Зеленый</b> индикатор продолжает мигать
8. Дважды нажмите кнопку KEY (двойной щелчок) 		<b>Красный</b> постоянно горящий индикатор сменится на <b>зеленый</b> постоянно горящий индикатор, сигнализируя об успешном изменении пользовательского PIN-кода



**Примечание:** если при установке нового пользовательского PIN-кода произошла ошибка или процедура не была завершена, накопитель сохранит старый PIN-код.

## 5. Включение опций

Режим опций позволяет пользователю выполнять различные функции, например, включать или отключать режим 'только для чтения' DT2000, устанавливать автоматическую блокировку по времени, а также определить версию устройства.

В таблице ниже указано, как перейти в режим опций, в разделах 6 - 9 описывается процесс выполнения различных функций.

Инструкции	Индикатор	Состояние индикатора
1. Нажмите один раз кнопку KEY 		<b>Красный</b> , <b>зеленый</b> и <b>синий</b> индикаторы одновременно загорятся, а затем <b>красный</b> индикатор продолжит мигать
2. В течение 10 секунд введите пользовательский PIN-код (по умолчанию - 11223344) для разблокировки DT2000		<b>Красный</b> индикатор продолжит мигать
3. Нажмите один раз кнопку KEY 		<b>Красный</b> постоянно горящий индикатор сменится на <b>зеленый</b> постоянно горящий индикатор, сигнализируя о правильном вводе пользовательского PIN-кода
4. Трижды нажмите кнопку KEY (тройной щелчок) 		<b>Зеленый</b> и <b>синий</b> индикаторы замигают вместе, ожидая новых инструкций в режиме OPTIONS (Опции).

## 6. Включение режима «только для чтения»

USB-накопитель DT2000 имеет режим «только для чтения», который ограничивает доступ для записи на накопитель. Его можно включить, выполнив следующие действия.

Инструкции	Индикатор	Состояние индикатора
1. Разблокируйте USB-накопитель DT2000, введя пользовательский PIN-код	 → 	<b>Красный</b> постоянно горящий индикатор сменится на <b>зеленый</b> постоянно горящий индикатор, сигнализируя о правильном вводе пользовательского PIN-кода
2. Включите опции, трижды нажав кнопку KEY (тройной щелчок) 	 & 	<b>Зеленый</b> и <b>синий</b> индикаторы мигают вместе, ожидая новых инструкций в режиме OPTIONS (Опции).
3. В течение 10 секунд начните нажимать кнопку цифры 7 ( <b>pqrs</b> ), а затем цифры 6 ( <b>mno</b> ) (76)	 & 	<b>Зеленый</b> и <b>синий</b> индикаторы продолжают мигать вместе
4. Нажмите один раз кнопку KEY 	 → 	<b>Синий</b> индикатор быстро отключится, сменившись постоянно горящим <b>зеленым</b> - при вставке USB-накопителя DT2000 в порт USB <b>зеленый</b> индикатор начнет мигать каждые две секунды, сигнализируя о том, что накопитель находится в режиме «только для чтения»













**Примечание:** Мы применили способ наименования, позволяющий пользователю запомнить последовательности клавиш для каждой настройки опций. В таблице ниже приведены цифры, соответствующие первым буквам названия функции опций. Например, **Read-Only** (только для чтения) = 7 (pqrs) 6 (mno).

## 7. Включение режима чтения и записи

Доступ с защитой от записи (режим «только для чтения») можно отключить с восстановлением режима чтения и записи.

Эту функцию можно включить, выполнив следующие действия.

Инструкции	Индикатор	Состояние индикатора
1. Разблокируйте USB-накопитель DT2000, введя пользовательский PIN-код	 → 	<b>Красный</b> постоянно горящий индикатор сменится на <b>зеленый</b> постоянно горящий индикатор, сигнализируя о правильном вводе пользовательского PIN-кода
2. Включите опции, трижды нажав кнопку KEY (тройной щелчок) 	 & 	<b>Зеленый</b> и <b>синий</b> индикаторы мигают вместе, ожидая новых инструкций в режиме OPTIONS (Опции).
3. В течение 10 секунд нажмите кнопку цифры 7 ( <b>pqrs</b> ), а затем цифры 9 ( <b>wxyz</b> ) (79)	 & 	<b>Зеленый</b> и <b>синий</b> индикаторы продолжают мигать вместе
4. Нажмите один раз кнопку KEY 	 → 	<b>Синий</b> индикатор быстро отключится, сменившись постоянно горящим <b>зеленым</b> - при вставке USB-накопителя DT2000 в порт USB <b>зеленый</b> индикатор начнет мигать каждые две секунды, сигнализируя о том, что накопитель находится в режиме чтения и записи

После активации восстанавливается состояние чтения и записи по умолчанию.



## 8. Установка режима блокировки по времени

Для защиты от несанкционированного доступа к подключенному к хост-устройству USB-накопителю DT2000, накопитель DT2000 можно установить в режим автоматической блокировки через заданный промежуток времени.











В состоянии по умолчанию блокировка по времени USB-накопителя DT2000 отключена. Для функции блокировки по времени можно указать промежуток времени блокировки от 1 до 99 минут.

Для установки режима блокировки по времени выполните действия, указанные в таблице ниже.













Инструкции	Индикатор	Состояние индикатора
1. Разблокируйте USB-накопитель DT2000, введя пользовательский PIN-код	 → 	<b>Красный</b> постоянно горящий индикатор сменится на <b>зеленый</b> постоянно горящий индикатор, сигнализируя о правильном вводе пользовательского PIN-кода
2. Включите опции, трижды нажав кнопку KEY (тройной щелчок)   	 & 	<b>Зеленый</b> и <b>синий</b> индикаторы мигают вместе, ожидая новых инструкций в режиме OPTIONS (Опции)
3. В течение 10 секунд нажмите кнопку цифры <b>8</b> (tuv), а затем цифры <b>5</b> (jkl) - (85)	 & 	<b>Зеленый</b> и <b>синий</b> индикаторы продолжают мигать вместе
4. Нажмите один раз кнопку KEY 		Мигающий <b>зеленый</b> индикатор
5. В течение 10 секунд введите промежуток блокировки по времени двумя цифрами: 00 = 0 минут (по умолчанию) 01 = 1 минута 99 = 99 минут и т.д.		<b>Зеленый</b> индикатор продолжает мигать
6. Нажмите один раз кнопку KEY 		<b>Зеленый</b> индикатор постоянно горит - блокировка по времени включена

## 9. Отключение режима блокировки по времени

Для отключения режима блокировки по времени выполните действия, указанные в таблице ниже.

Инструкции	Индикатор	Состояние индикатора
1. Разблокируйте USB-накопитель DT2000, введя пользовательский PIN-код	 → 	<b>Красный</b> постоянно горящий индикатор сменится на <b>зеленый</b> постоянно горящий индикатор, сигнализируя о правильном вводе пользовательского PIN-кода
2. Включите опции, трижды нажав кнопку KEY (тройной щелчок)   	 & 	<b>Зеленый</b> и <b>синий</b> индикаторы мигают вместе, ожидая новых инструкций в режиме OPTIONS (Опции)
3. В течение 10 секунд нажмите кнопку цифры <b>8</b> (tuv), а затем цифры <b>5</b> (jkl) - (85)	 & 	<b>Зеленый</b> и <b>синий</b> индикаторы продолжают мигать вместе
4. Нажмите один раз кнопку KEY 		Мигающий <b>зеленый</b> индикатор
5. В течение 10 секунд дважды нажмите кнопку цифры <b>0</b> (двойной щелчок) ( <b>ноль</b> - (00))		<b>Зеленый</b> индикатор продолжает мигать
6. Нажмите один раз кнопку KEY 		<b>Зеленый</b> индикатор постоянно горит - блокировка по времени отключена

## 10. Определение номера версии USB-накопителя DT2000

Инструкции	Индикатор	Состояние индикатора
1. Разблокируйте USB-накопитель DT2000, введя пользовательский PIN-код	 → 	<b>Красный</b> постоянно горящий индикатор сменится на <b>зеленый</b> постоянно горящий индикатор, сигнализируя о правильном вводе пользовательского PIN-кода
2. Включите опции, трижды нажав кнопку KEY (тройной щелчок) 	 & 	<b>Зеленый</b> и <b>синий</b> индикаторы мигают вместе, ожидая новых инструкций в режиме OPTIONS (Опции)
3. В течение 10 секунд нажмите кнопку цифры <b>8</b> (tuv), а затем цифры <b>6</b> (mno) - ( <b>86</b> )	 & 	<b>Зеленый</b> и <b>синий</b> индикаторы продолжают мигать вместе
4. Нажмите один раз кнопку KEY 	    → 	<b>Красный</b> , <b>зеленый</b> и <b>синий</b> одновременно быстро мигнут, затем <b>красный</b> индикатор промигает первую значимую цифру версии, а <b>зеленый</b> индикатор промигает вторую значимую цифру номера версии
Например, если версия имеет номер «1.8», <b>красный</b> индикатор мигнет один раз (1), а <b>зеленый</b> индикатор - восемь раз (8). После завершения последовательности <b>красный</b> , <b>зеленый</b> и <b>синий</b> индикаторы мигнут вместе, затем будет постоянно гореть <b>зеленый</b> индикатор.		

## 11. Распознавание взлома методом перебора



**Внимание:** если пользователь введет неправильный пользовательский PIN-код 10 (десять) раз подряд, включится механизм DT2000 от взлома методом перебора, и пользовательский PIN-код, ключ шифрования, а также все данные будут удалены и безвозвратно утеряны.

PIN-код, используемый для разблокировки USB-накопителя DT2000	Что произойдет после 10 последовательных неправильных вводов PIN-кода?
Пользовательский PIN-код	Сработает механизм защиты DT2000 от взлома методом перебора и пользовательский PIN-код, ключ шифрования и все данные будут удалены и безвозвратно утеряны.

Если пользователь 10 (десять) раз подряд введет неправильный PIN-код, ключ шифрования и все данные будут удалены и безвозвратно утеряны. Затем USB-накопитель DT2000 переключится на заводской пользовательский PIN-код по умолчанию (11223344) - инструкцию по изменению пользовательского PIN-кода см. в разделе 4 на странице 6. Кроме того, это приведет к созданию нового ключа шифрования, при этом потребуются повторное форматирование USB-накопителя DT2000 (см. раздел 13 или 14).

В отличие от других накопителей, USB-накопитель DT2000 имеет генератор случайных чисел. После выполнения сброса накопителя случайным образом создается новый ключ шифрования.

## 12. Выполнение сброса USB-накопителя DT2000

В случае, если пользовательский PIN-код был забыт, или пользователь хочет удалить все данные, хранящиеся на USB-накопителе DT2000, выполните инструкции, приведенные ниже.

Процесс сброса удалит все криптографические параметры, в том числе и пользовательский PIN-код. Это означает, что USB-накопитель DT2000 переключится на заводской пользовательский PIN-код по умолчанию (11223344) - инструкцию по изменению пользовательского PIN-кода см. в разделе 4 на странице 6. Кроме того, это приведет к созданию нового ключа шифрования, при этом потребуется повторное форматирование USB-накопителя DT2000 (см. раздел 13 или 14).



**Внимание:** выполнение сброса USB-накопителя DT2000 удалит **все данные**, хранящиеся на накопителе.

Инструкции	Индикатор	Состояние индикатора
1. Нажмите и удерживайте кнопку цифры <b>7</b> (pqrs), затем нажмите кнопку KEY  . Отпустите кнопки ( <b>7</b> и  )	 / 	<b>Красный</b> и <b>зеленый</b> индикаторы начнут попеременно загораться
2. В течение 10 секунд трижды нажмите кнопку цифры <b>9</b> (wxyz) (тройной щелчок) ( <b>999</b> )	 / 	<b>Красный</b> и <b>зеленый</b> индикаторы продолжают попеременно загораться
3. Нажмите и удерживайте кнопку цифры <b>7</b> (pqrs), затем нажмите кнопку KEY  . Отпустите кнопки ( <b>7</b> и  )		<b>Красный</b> индикатор отключится, сообщая о завершении процесса сброса

## 13. Настройка USB-накопителя DT2000 для работы с ОС Windows

В случае, когда функция распознавания взлома срабатывает при **неправильно введенном 10 раз PIN-коде**, или после выполнения сброса накопителя **все данные на накопителе будут безвозвратно утеряны**.

После создания нового **пользовательского PIN-кода** USB-накопитель DT2000 должен быть инициализирован и отформатирован.

**Для инициализации USB-накопителя DT2000 выполните следующее:**

1. Создайте новый **пользовательский PIN-код** (см. раздел 4).
2. Разблокируйте USB-накопитель DT2000, введя новый **пользовательский PIN-код**, и подключите накопитель к порту USB компьютера.
3. Компьютер отобразит следующее сообщение:

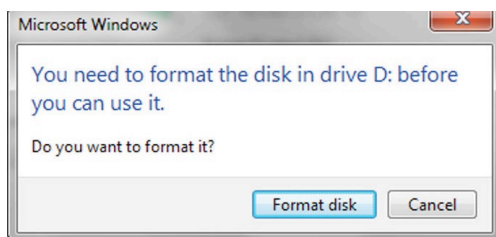

4. Продолжите, нажав на **Форматировать диск**. Выберите нужную файловую систему (**FAT32** или **NTFS**) введите **Метку тома** и нажмите **Начать**.

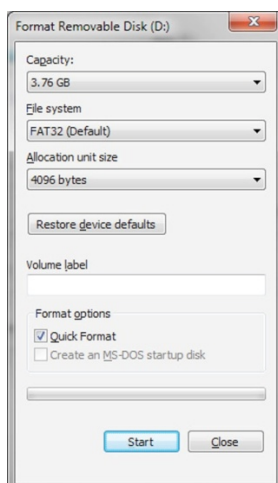

5. Нажмите **ОК**, чтобы продолжить форматирование накопителя.

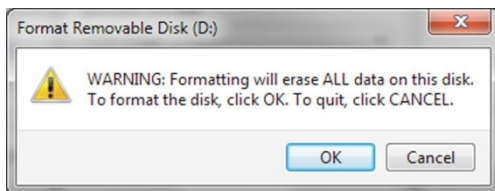

**Внимание:** эта процедура удалит **все данные**, хранящиеся на накопителе.

6. Компьютер закончит форматирование накопителя и подтвердит завершение форматирования. В процессе форматирования USB-накопителя DT2000 мигает **синий** индикатор.

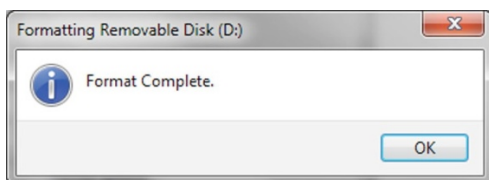

После завершения **синий** индикатор начинает гореть постоянно; DT2000 готов к использованию.

**Если мастер форматирования не открылся, выполните следующую процедуру:**

1. Правой клавишей мыши нажмите на **Мой компьютер** или **Компьютер**, затем нажмите на **Управление**.
2. Во вкладке **Управление дисками** окна **Управление компьютером** DT2000 распознается как неотформатированное съемное устройство.

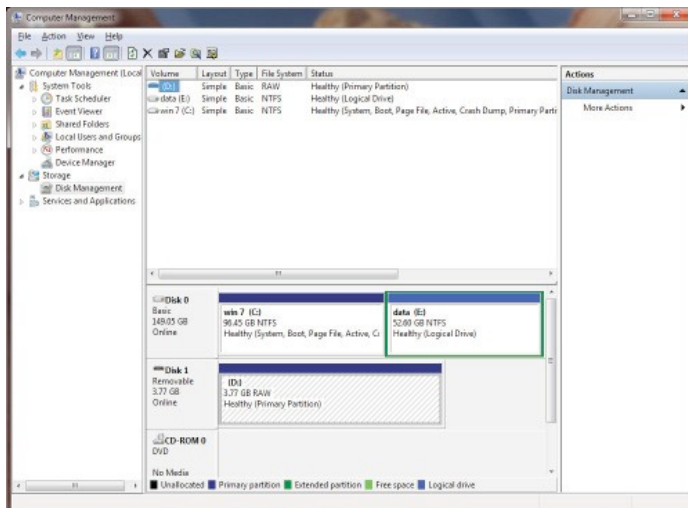

3. В пустой области нераспределенного пространства нажмите правой клавишей мыши на **Неотформатированное съемное устройство** и выберите **Форматирование**.

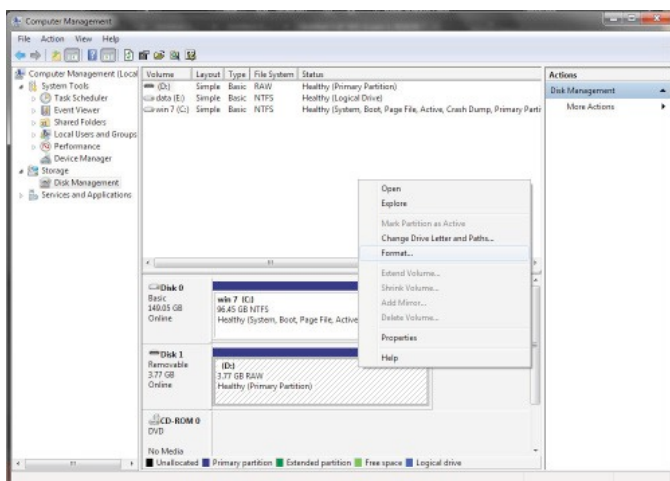

4. Откроется окно **Форматирование**. Введите новую **Метку тома**. Выберите нужную файловую систему (**FAT32** или **NTFS**) и нажмите на **OK**.

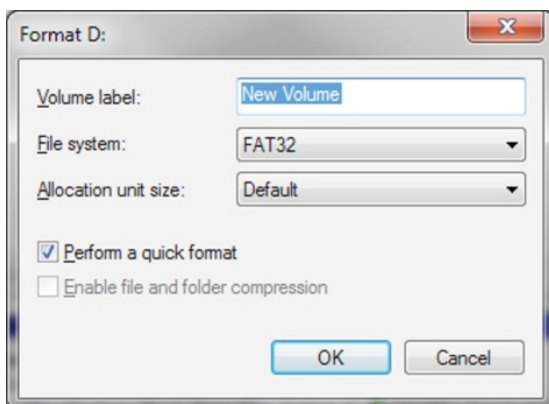

5. Нажмите на **OK** в окне **Форматирование** и продолжите форматирование накопителя.

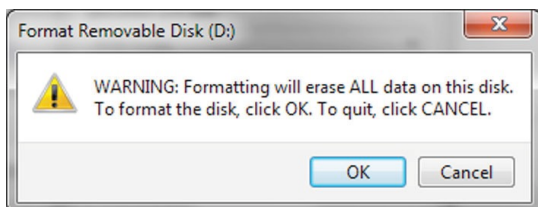

**Внимание:** эта процедура удалит **все данные**, хранящиеся на накопителе.

6. Компьютер завершит форматирование и вернется в окно **Управление дисками**.  
В процессе форматирования USB-напителя DT2000 мигает **синий** индикатор.

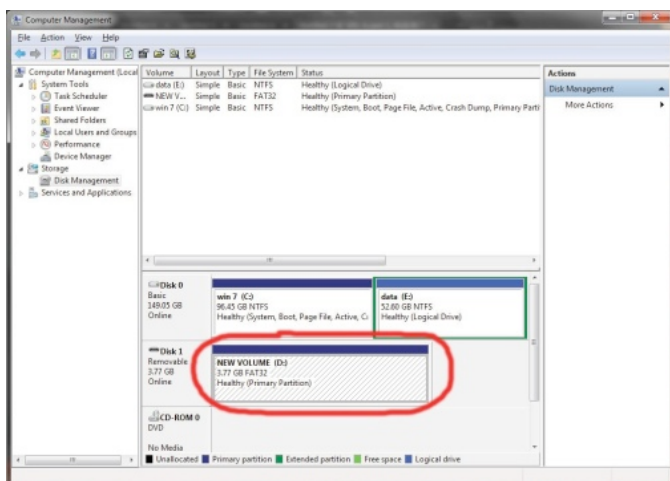

После завершения **синий** индикатор начинает гореть постоянно; DT2000 готов к использованию.

## 14. Настройка USB-напитателя DT2000 для работы с Mac OS

В случае, когда функция распознавания взлома срабатывает при неправильно введенном 10 раз PIN-коде, или после выполнения сброса накопителя **все данные в накопителе будут безвозвратно утеряны**.

После создания нового **пользовательского PIN-кода** USB-накопитель DT2000 должен быть инициализирован и отформатирован.

Для форматирования USB-напитателя DT2000 на компьютерах Mac OS выполните следующее:

1. Создайте новый **пользовательский PIN-код** (см. раздел 4).
2. Разблокируйте USB-накопитель DT2000, введя новый **пользовательский PIN-код**, и подключите накопитель к порту USB компьютера Mac. Откроется окно **ИНИЦИАЛИЗАЦИЯ**.

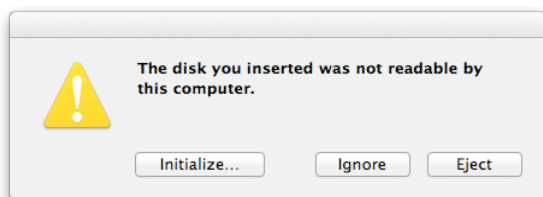

3. Нажмите на **ИНИЦИАЛИЗАЦИЯ** и выберите DT2000 в окне **Дисковая утилита**.

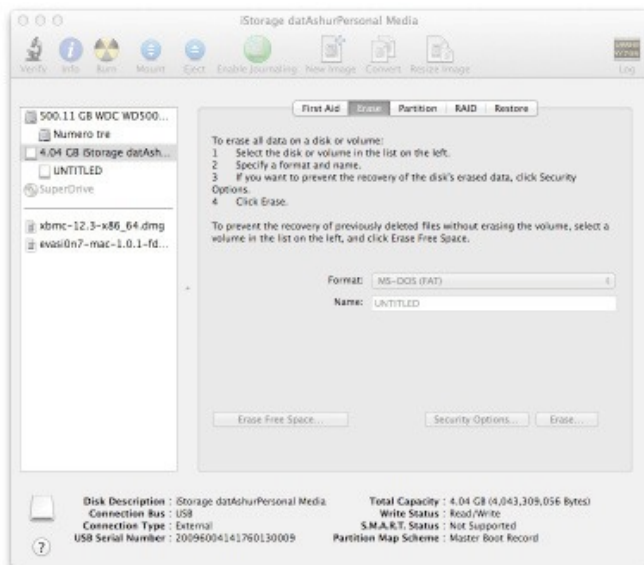

4. Нажмите на DT2000 в левой части окна **Дисковая утилита**.
5. Выберите в контекстном меню в правой части окна **Удалить**. Выберите **MS-DOS** в качестве **Формата тома**.
6. Нажмите на **Удалить**.

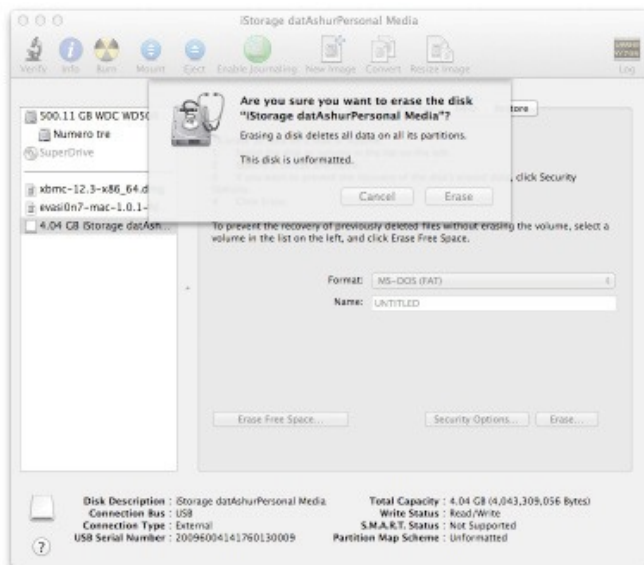



7. Отформатированный USB-накопитель DT2000 отобразится в окне **Дисковая утилита** и смонтируется на рабочем столе.

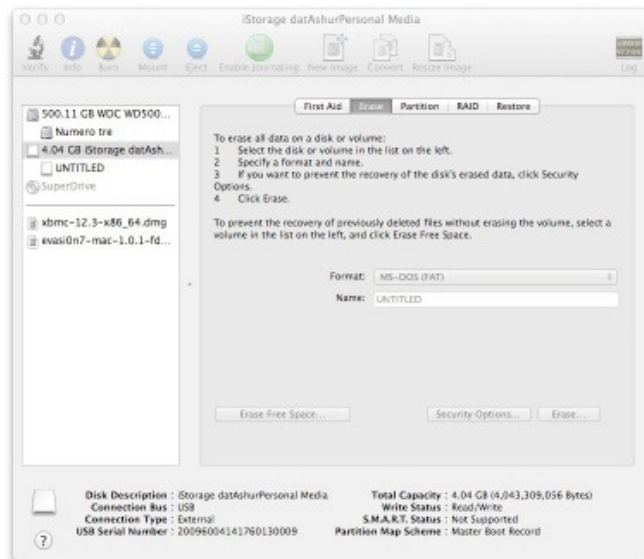

## Информация об аккумуляторе/утилизация продукции

Не выбрасывайте электрические устройства или устройства, содержащие аккумуляторы, вместе с обычным бытовым мусором. Электронные устройства необходимо безопасно утилизировать, чтобы минимизировать вред окружающей среде. Не пытайтесь извлечь аккумулятор из устройства, этим должна заниматься исключительно компания Kingston или профессиональный поставщик услуг. Свяжитесь с нами для получения дополнительной информации об аккумуляторе и безопасной утилизации нашей продукции.

В USB-накопителе DataTraveler® 2000 используется технология DataLock® компании ClevX, LLC.

## DataTraveler® 2000 - Kullanıcı Kılavuzu



**PIN'inizi güvenli bir yerde saklamayı unutmayın. Kaybetmeniz ya da unutmanız halinde, Kingston DataTraveler®'da saklanan verilere erişmenin başka bir yolu bulunmamaktadır.**

**Eğer zorluk yaşıyorsanız lütfen DT2000'inize yüklü olan ya da Kingston web sitesinde bulunan bu eksiksiz kullanıcı kılavuzuna bakın: [kingston.com/support](http://kingston.com/support)**

DataTraveler® 2000'de lisansı ClevX, LLC'ye ait DataLock® Teknolojisi bulunmaktadır.

## İçindekiler

Sistem Gereksinimleri.....	3
Giriş .....	4
1. DT2000 Düzeni .....	5
2. LED göstergeleri ve işlevleri .....	5
3. DT2000'nin ilk kez kullanılması .....	6
4. Kullanıcı PIN'inin Değiştirilmesi.....	6
5. Seçeneklerin etkinleştirilmesi.....	7
6. Salt Okunur Modun etkinleştirilmesi.....	8
7. Okuma/Yazma Modunun etkinleştirilmesi.....	8
8. Zaman Aşımı Kilit Modunun ayarlanması .....	9
9. Zaman Aşımı Kilit Modunun devre dışı bırakılması .....	9
10. DT2000 Sürüm Numarasının belirlenmesi .....	10
11. Kaba Güç (Brute Force) Korsanlığının Algılanması .....	10
12. DT2000'nin Sıfırlanması.....	11
13. DT2000'nin Windows İşletim Sisteminde yapılandırılması .....	12
14. DT2000'nin MAC İşletim Sisteminde yapılandırılması .....	15

## ***Bu Kılavuz Hakkında***

Bu kullanıcı kılavuzu Kingston DataTraveler® 2000 içindir (bundan sonra kolaylık için DT2000 olarak ifade edilecektir).

## **Sistem Gereksinimleri**

---

### **PC Platformu**

### **PC İşletim Sistemi Desteği**

- Windows 10
  - Windows 8/8.1
  - Windows 7
  - Windows Vista® SP2
- 

### **Mac Platformu**

### **İşletim Sistemi Desteği**

- Mac OS X 10.8.x - 10.11x
- 

### **Linux Platformu**

### **İşletim Sistemi Desteği**

- Linux v2.6 kernel+
- 

### **Diğer Platformlar**

### **İşletim Sistemi Desteği**

- Chrome OS™, Android\*
- 

\*Yalnızca uyumlu cihazlarda. USB Flash Sürücülerini destekleyip desteklemediğini öğrenmek için cihazınızın üreticisiyle görüşün.

## GİRİŞ



**Not:** DT2000'nin şarj edilebilir pili, kutudan çıktığında şarjlı değildir. İlk kullanımdan önce pilin şarj edilmesini öneriyoruz. Şarj etmek için DT2000'i 60 dakika boyunca elektrik sağlayabilen bir USB bağlantı noktasına takarak pili tam olarak şarj edin.

Kolay kullanımlı donanımsal şifreleme sunan USB 3.0 PIN ile etkinleştirilen bir flash sürücü olan DataTraveler® 2000'i satın aldığınız için teşekkür ederiz.



DT2000, sürücü üzerindeki verileri gerçek zamanlı olarak şifreleyen askeri sınıf XTS-AES 256-bit donanımsal şifreleme sistemini kullanmaktadır. DT2000 herhangi bir yazılım gerektirmez ve işletim sistemi ve ana cihazdan bağımsızdır.

DT2000, sürücüyü bir USB bağlantı noktasına takmadan önce üzerindeki tuş takımı ile 7-15 basamaklı bir PIN (Kişisel Tanımlama Numarası) girmenizi sağlayan şarj edilebilir bir pile sahiptir.

Sürücü kaybolur ya da çalınırsa, kullanıcı DT2000 üzerindeki verilerin güvende olduğunu ve yetkisiz kişilerin bunlara erişemeyeceğini bilerek rahat hissedebilir.

DT2000'nin kilidi, üzerindeki tuş takımı ile açılabilir. Kilit, takıldığı ana cihaz tarafından açılmaz. Yazılım/donanım tabanlı anahtar kaydedicilerden ya da kaba güç (brute force) saldırılarından etkilenmez.









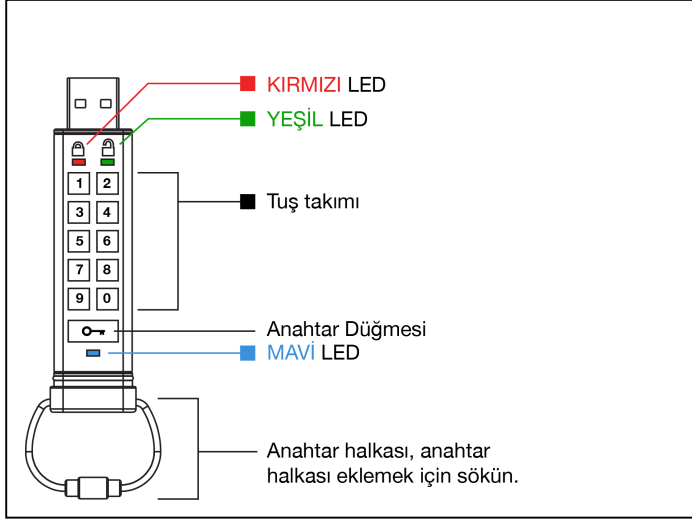







**Dikkat:** DT2000, varsayılan bir Kullanıcı PIN'i ile gelmektedir:  1-1-2-2-3-3-4-4  ve varsayılan PIN ile doğrudan kutudan çıktığı gibi kullanılabilir olmasına karşın Bölüm 4, «Kullanıcı PIN'inin Değiştirilmesi» konusunda verilen talimatlar izlenerek **hemen yeni bir Kullanıcı PIN'inin belirlenmesi kesinlikle önerilmektedir.**

Eğer PIN'inizi unutursanız verilerinize ulaşamazsınız.

## 1. DT2000 Düzeni



## 2. LED göstergeleri ve işlevleri

LED	LED Durumu	Açıklama	LED Durumu	Açıklama	Açıklama
	<b>Kırmızı Siyah</b> kademeli değişimli 	Kilitleniyor/yanlış PIN girişi		<b>Kırmızı ve Yeşil</b> değişken biçimde yanıp sönüyor 	Fabrika ayarlarına sıfırlama
	<b>Kırmızı</b> yanıp sönüyor 	Kilitli ve varsayılan fabrika PIN'in ya da tanımlanmış PIN'in girilmesini bekliyor			
	<b>Yeşil</b> sürekli 	DT2000'nin kilidi açık		<b>Yeşil ve Mavi</b> birlikte yanıp sönüyor 	Kullanıcı Seçenekleri Modu
	<b>Yeşil</b> yanıp sönüyor 	Bir USB bağlantı noktasına takılı olduğunda eğer <b>Yeşil</b> LED her 2 saniyede bir yanıp sönüyorsa, DT2000 'Salt Okunur' olarak ayarlanmıştır			
	<b>Mavi</b> sürekli 	Bir USB bağlantı noktasına takılı			
	<b>Mavi</b> yanıp sönüyor	Ana cihazla veri alışverişi var/Kullanıcı PIN'i değiştiriliyor			

### 3. DT2000'nin ilk kez kullanılması

DT2000, 11223344 varsayılan PIN'i ile gelmektedir ve doğrudan kutudan çıktığı gibi kullanılabilir. Olmasına karşın güvenlik nedenlerinden dolayı Bölüm 4 Kullanıcı PIN'inin Değiştirilmesi' konusunda verilen talimatlar izlenerek PIN'in hemen değiştirilmesi kesinlikle önerilmektedir.

Lütfen DT2000'in kilidini varsayılan PIN ile açmak için aşağıdaki tabloda verilen 3 basit adımı uygulayın.

Talimatlar (ilke kez kullanım)	LED	LED Durumu
1. ANAHTAR düğmesine bir kez basın 		<b>Kırmızı</b> , <b>Yeşil</b> ve <b>Mavi</b> LED'ler bir kez yanıp sönecek ve daha sonra <b>Kırmızı</b> LED yanıp sönmeye devam edecektir
2. 10 saniye içinde DT2000'i açmak için Kullanıcı PIN'ini (varsayılan - 11223344) girin		<b>Kırmızı</b> LED yanıp sönmeye devam edecektir
3. ANAHTAR düğmesine bir kez basın 		<b>Kırmızı</b> sürekli yanan LED <b>Yeşil</b> sürekli yanan LED'e dönüşerek varsayılan Kullanıcı PIN'inin doğru biçimde girildiğini gösterecektir.



**Not:** DT2000'nin kilidi başarıyla açıldıktan sonra **Yeşil** LED sadece 30 saniye boyunca sürekli yanar ve bu sırada DT2000'in bir USB bağlantı noktasına takılması gerekmektedir. ANAHTAR düğmesine  3 saniye boyunca basılı tutarak hemen, 30 saniyenin geçmesi beklenerek ya da işletim sisteminizdeki Donanımı Güvenle Kaldır ve Ortamı Çıkart' simgesi tıklanarak kilitlenebilir.

### 4. Kullanıcı PIN'inin Değiştirilmesi

PIN gereksinimleri:

- 7-15 karakter uzunluğunda olmalıdır
- Yalnızca tekrar eden numaralar içermemelidir, örn. (3-3-3-3-3-3-3)
- Yalnızca sıralı sayılar içermemelidir, örn. (1-2-3-4-5-6-7), (7-8-9-0-1-2-3-4), (7-6-5-4-3-2-1)

**Parola İpucu:** Üzerinde ilgili harflerin bulunduğu tuşa basarak hatırlayabileceğiniz bir sözcük, isim, ifade ya da başka bir harf ve sayı içeren PIN kombinasyonu oluşturabilirsiniz.

Bu tür harf ve sayı içeren PIN'lere örnek olarak şunlar gösterilebilir:

- **"password"** için aşağıdaki tuşlara basmanız gerekir:  
7 (pqrs) 2 (abc) 7 (pqrs) 7 (pqrs) 9 (wxyz) 6 (mno) 7 (pqrs) 3 (def)
- **"kingston"** için aşağıdaki tuşlara basmanız gerekir:  
5 (jkl) 4 (ghi) 6 (mno) 4 (ghi) 7 (pqrs) 8 (tuv) 6 (mno) 6 (mno)

Bu yöntemi kullanarak uzun ve kolay hatırlanabilir PIN'ler oluşturulabilir.

Talimatlar	LED	LED Durumu
1. ANAHTAR düğmesine bir kez basın 		<b>Kırmızı</b> , <b>Yeşil</b> ve <b>Mavi</b> LED'ler bir kez yanıp sönecek ve daha sonra <b>Kırmızı</b> LED yanıp sönmeye devam edecektir
2. 10 saniye içinde DT2000'i açmak için Kullanıcı PIN'ini (varsayılan - 11223344) girmeye başlayın		<b>Kırmızı</b> LED yanıp sönmeye devam edecektir
3. ANAHTAR düğmesine bir kez basın 		<b>Kırmızı</b> sürekli yanan LED <b>Yeşil</b> sürekli yanan LED'e dönüşerek varsayılan Kullanıcı PIN'inin doğru biçimde girildiğini gösterecektir.
4. ANAHTAR düğmesine iki kez basın (çift tıklatma)  		<b>Mavi</b> LED yanıp söner
5. 10 saniye içinde Yeni Kullanıcı PIN'ini girmeye başlayın		<b>Mavi</b> LED yanıp sönmeye devam eder
6. ANAHTAR düğmesine iki kez basın (çift tıklatma)  		<b>Yeşil</b> LED yanıp söner
7. 10 saniye içinde Yeni Kullanıcı PIN'ini tekrar girmeye başlayın		<b>Yeşil</b> LED yanıp sönmeye devam eder
8. ANAHTAR düğmesine iki kez basın (çift tıklatma)  		<b>Kırmızı</b> sürekli yanan LED <b>Yeşil</b> sürekli yanan LED'e dönüşerek Kullanıcı PIN'inin başarıyla değiştirildiğini gösterir.











**Not:** Eğer yeni Kullanıcı PIN'ini tanımlarken bir hata yapılırsa ya da işlem tamamlanmazsa sürücüde eski PIN kayıtlı kalacaktır.

## 5. Seçeneklerin etkinleştirilmesi

Options (Seçenekler) Modu, kullanıcının DT2000'i 'Salt Okunur' olarak etkinleştirmek, bir 'Zaman Aşımı' otomatik kilit koymak ve cihazın sürümünü belirlemek gibi farklı işlevleri gerçekleştirmenizi sağlar.











Aşağıdaki tabloda Seçenekler moduna nasıl girilebileceğini göstermektedir Bölümler 6 - 9 çeşitli işlevleri nasıl gerçekleştirebileceğinizi açıklamaktadır.

Talimatlar	LED	LED Durumu
1. ANAHTAR düğmesine bir kez basın 		<b>Kırmızı</b> , <b>Yeşil</b> ve <b>Mavi</b> LED'ler bir kez yanıp sönecek ve daha sonra <b>Kırmızı</b> LED yanıp sönmeye devam edecektir
2. 10 saniye içinde Kullanıcı PIN'ini girerek (varsayılan - 11223344) DT2000'in kilidini açın		<b>Kırmızı</b> LED yanıp sönmeye devam edecektir
3. ANAHTAR düğmesine bir kez basın 		<b>Kırmızı</b> sürekli yanan LED <b>Yeşil</b> sürekli yanan LED'e dönüşerek Kullanıcı PIN'inin doğru biçimde girildiğini gösterecektir
4. ANAHTAR düğmesine 3 kez basın (üçlü tıklatma)   		<b>Yeşil</b> ve <b>Mavi</b> LED'ler birlikte yanıp söner, SEÇENEKLER Modunda yeni talimatları beklediğini gösterir.



## 6. Salt Okunur Modun etkinleştirilmesi

DT2000, sürücüye yazma erişimini kısıtlayan bir salt okunur moda sahiptir. Bu işlem aşağıdaki adımlar gerçekleştirilerek yapılır.

Talimatlar	LED	LED Durumu
1. Kullanıcı PIN'i ile DT2000'nin kilidini açın	 → 	<b>Kırmızı</b> sürekli yanan LED <b>Yeşil</b> sürekli yanan LED'e dönüşerek Kullanıcı PIN'inin doğru biçimde girildiğini gösterecektir.
2. ANAHTAR düğmesine 3 kez basarak (üçlü tıklatma)  Seçenekler modunu etkinleştirin	 & 	<b>Yeşil</b> ve <b>Mavi</b> LED'ler birlikte yanıp sönerek, SEÇENEKLER Modunda yeni talimatları beklediğini gösterir.
3. 10 saniye içinde 7 (pqrs) düğmesine, ardından 6 (mno) düğmesine (76) basın	 & 	<b>Yeşil</b> ve <b>Mavi</b> LED'ler birlikte yanıp sönmeye devam eder
4. ANAHTAR düğmesine bir kez basın 	 → 	<b>Mavi</b> LED çabucak sürekli yanan <b>Yeşil</b> LED'e değişir - DT2000 USB bağlantı noktasına takıldığında <b>Yeşil</b> LED her iki saniyede bir yanıp sönerek sürücünün Salt Okunur Modda olduğunu gösterir.











Etkinleştirildiğinde yazma koruması devre dışı bırakılana kadar erişim Salt Okunur olacaktır.



**Not:** Kullanıcının her isteğe bağlı ayarın tuşlarını hatırlamalarını kolaylaştırmak için bir isimlendirme tekniği kullandık. Yukarıdaki tabloda isteğe bağlı özelliğin adını belirtmek için özelliğin 'baş harflerini' kullandık. Örneğin, Salt Okunur (Read Only) için **Read-Only** = 7 (pqrs) 6 (mno).

## 7. Okuma/Yazma Modunun etkinleştirilmesi

Kısıtlı yazma koruması (Salt Okunur) erişimi, kapatılabilir ve Okuma/Yazma erişimi açılabilir. Bu işlem aşağıdaki Adımlar gerçekleştirilerek yapılır.

Talimatlar	LED	LED Durumu
1. Kullanıcı PIN'i ile DT2000'nin kilidini açın	 → 	<b>Kırmızı</b> sürekli yanan LED <b>Yeşil</b> sürekli yanan LED'e dönüşerek Kullanıcı PIN'inin doğru biçimde girildiğini gösterecektir.
2. ANAHTAR düğmesine 3 kez basarak (üçlü tıklatma)  Seçenekler modunu etkinleştirin	 & 	<b>Yeşil</b> ve <b>Mavi</b> LED'ler birlikte yanıp sönerek, SEÇENEKLER Modunda yeni talimatları beklediğini gösterir.
3. 10 saniye içinde 7 (pqrs) ardından 9 (wxyz) düğmesine (79) basın	 & 	<b>Yeşil</b> ve <b>Mavi</b> LED'ler birlikte yanıp sönmeye devam eder
4. ANAHTAR düğmesine bir kez basın 	 → 	<b>Mavi</b> LED çabucak sürekli yanan <b>Yeşil</b> LED'e değişir - DT2000 USB bağlantı noktasına takıldığında <b>Yeşil</b> LED her iki saniyede bir yanıp sönerek sürücünün Okuma/Yazma Modunda olduğunu gösterir.









Etkinleştirildiğinde erişim varsayılan Okuma/Yazma durumuna geri döner.

## 8. Zaman Aşımı Kilit Modunun ayarlanması

DT2000 ana cihaza takılı olduğunda ve başında siz yokken gerçekleşebilecek yetkisiz erişimlere karşı korumak için, DT2000 önceden belirlenmiş bir süre sonunda otomatik olarak kilitlenecek şekilde ayarlanabilir.









Varsayılan durumda DT2000'nin Zaman Aşımı Kilidi özelliği kapalıdır. Zaman Aşımı Kilidi özelliği 1-99 dakika arasında herhangi bir süre sonunda etkinleştirilecek (kilit) şekilde ayarlanabilir.

Zaman Aşımı Kilidini ayarlamak için lütfen aşağıdaki tabloda verilen adımları uygulayın.

Talimatlar	LED	LED Durumu
1. Kullanıcı PIN'i ile DT2000'nin kilidini açın		<b>Kırmızı</b> sürekli yanan LED <b>Yeşil</b> sürekli yanan LED'e dönüşerek Kullanıcı PIN'inin doğru biçimde girildiğini gösterecektir.
2. ANAHTAR düğmesine 3 kez basarak (üçlü tıklatma) Seçenekler modunu etkinleştirin 		<b>Yeşil</b> ve <b>Mavi</b> LED'ler birlikte yanıp sönmeye devam eder, SEÇENEKLER Modunda yeni talimatları beklediğini gösterir.
3. Zaman Aşımı Kilidi (Timeout Lock) için 10 saniye içinde <b>8</b> (tuv), ardından <b>5</b> (jkl) düğmesine - ( <b>85</b> ) basın		<b>Yeşil</b> ve <b>Mavi</b> LED'ler birlikte yanıp sönmeye devam eder
4. ANAHTAR düğmesine bir kez basın 		Yanıp Sönen <b>Yeşil</b> LED
5. 10 saniye içinde 2 basamaklı olarak Kullanıcı Zaman Aşımı süresini girin: 00 = 0 dakika (Varsayılan) 01 = 1 dakika 99 = 99 dakika vb.		<b>Yeşil</b> LED yanıp sönmeye devam eder
6. ANAHTAR düğmesine bir kez basın 		<b>Yeşil</b> sürekli yanan LED - Zaman Aşımı Kilidi Etkin

## 9. Zaman Aşımı Kilit Modunun devre dışı bırakılması

Zaman Aşımı Kilidini devre dışı bırakmak için lütfen aşağıdaki tabloda verilen adımları uygulayın.

Talimatlar	LED	LED Durumu
1. Kullanıcı PIN'i ile DT2000'nin kilidini açın		<b>Kırmızı</b> sürekli yanan LED <b>Yeşil</b> sürekli yanan LED'e dönüşerek Kullanıcı PIN'inin doğru biçimde girildiğini gösterecektir.
2. ANAHTAR düğmesine 3 kez basarak (üçlü tıklatma)  Seçenekler modunu etkinleştirin		<b>Yeşil</b> ve <b>Mavi</b> LED'ler birlikte yanıp sönmeye devam eder, SEÇENEKLER Modunda yeni talimatları beklediğini gösterir.
3. 10 saniye içinde <b>8</b> (tuv) ardından <b>5</b> (jkl) düğmesine - ( <b>85</b> ) basın		<b>Yeşil</b> ve <b>Mavi</b> LED'ler birlikte yanıp sönmeye devam eder
4. ANAHTAR düğmesine bir kez basın 		Yanıp Sönen <b>Yeşil</b> LED
5. 10 saniye içinde <b>0</b> düğmesine iki kez (çift tıklama) ( <b>sıfır sıfır</b> ) - ( <b>00</b> ) basın		<b>Yeşil</b> LED yanıp sönmeye devam eder
6. ANAHTAR düğmesine bir kez basın 		<b>Yeşil</b> sürekli yanan LED - Zaman Aşımı Kilidi devre dışı

## 10. DT2000 Sürüm Numarasının belirlenmesi

Talimatlar	LED	LED Durumu
1. Kullanıcı PIN'i ile DT2000'nin kilidini açın		<b>Kırmızı</b> sürekli yanan LED <b>Yeşil</b> sürekli yanan LED'e dönüşerek Kullanıcı PIN'inin doğru biçimde girildiğini gösterecektir.
2. ANAHTAR düğmesine 3 kez basarak (üçlü tıklatma) Seçenekler modunu etkinleştirin 		<b>Yeşil</b> ve <b>Mavi</b> LED'ler birlikte yanıp sönmeye devam eder.
3. 10 saniye içinde 8 (tuv), ardından 6 (mno) düğmesine - (86) basın		<b>Yeşil</b> ve <b>Mavi</b> LED'ler birlikte yanıp sönmeye devam eder
4. ANAHTAR düğmesine bir kez basın 	 	<b>Kırmızı</b> , <b>Yeşil</b> ve <b>Mavi</b> LED'ler hızla yanıp sönecek ve bunu takiben <b>Kırmızı</b> LED sürümün ilk numarası kadar yanıp sönecek, ardından <b>Yeşil</b> LED sürüm numarasının ikinci basamağı kadar yanıp sönecektir

Örneğin eğer sürüm numarası «1.8». ise **Kırmızı** LED bir kez (1) ve **Yeşil** LED sekiz (8) kez yanıp söner. İşlem tamamlandığında **Kırmızı**, **Yeşil** ve **Mavi** LED'ler bir kez daha yanıp söner ve daha sonra **Yeşil** sürekli yanacaktır.

## 11. Kaba Güç (Brute Force) Korsanlığının Algılanması



**Dikkat:** Eğer kullanıcı, Kullanıcı PIN'ini üst üste 10 (on) kez yanlış girerse, DT2000'nin kaba güç (brute force) mekanizması devreye girecek ve Kullanıcı PIN'i, şifreleme anahtarı ve içindeki tüm veriler geri alınamayacak şekilde silinecektir.

DT2000'nin kilidini açmak için kullanılan PIN	PIN 10 kez üst üste yanlış girildiğinde ne olur?
Kullanıcı PIN'i	DT2000'nin kaba güç (brute force) mekanizması devreye girer ve Kullanıcı PIN'i, şifreleme anahtarı ve tüm veriler geri alınamayacak şekilde silinir.

Eğer kullanıcı PIN'i 10 (on) kez üst üste yanlış girerse şifreleme anahtarı ve tüm veriler geri alınamayacak şekilde silinir. DT2000 daha sonra fabrika varsayılan Kullanıcı PIN'i 11223344'e geri döner - Kullanıcı PIN'inin nasıl değiştirileceğini öğrenmek için sayfa 6'daki Bölüm 4'e bakın. Ayrıca bu işlem yeni bir şifreleme anahtarının oluşturulmasını gerektireceğinden DT2000'nin yeniden biçimlendirilmesi gerekecektir (bkz. bölüm 13 ya da 14).

DT2000, diğer benzer cihazların aksine bir rastgele sayı üreticisine sahiptir. Sürücü sıfırlandığında yeni şifreleme anahtarı rastgele biçimde oluşturulur.

## 12. DT2000'nin Sıfırlanması

Kullanıcı PIN'inin unutulması durumunda ya da kullanıcı DT2000 üzerindeki tüm verileri silmek istediğinde aşağıdaki talimatlar uygulanmalıdır.

Sıfırlama işlemi Kullanıcı PIN'i dahil olmak üzere tüm kriptografik parametreleri silecektir. Yani DT2000 varsayılan Kullanıcı PIN'i 11223344'e geri döner - Kullanıcı PIN'inin nasıl değiştirileceğini öğrenmek için sayfa 6'daki Bölüm 4'e bakın. Ayrıca bu işlem yeni bir şifreleme anahtarının oluşturulmasını gerektireceğinden DT2000'nin yeniden biçimlendirilmesi gerekecektir (bkz. bölüm 13 ya da 14).



**Dikkat:** DT2000'nin sıfırlanması sürücü üzerindeki **tüm verilerin** silinmesine neden olacaktır.

Talimatlar	LED	LED Durumu
1. <b>7</b> (pqrs) düğmesine basılı tutun ve daha sonra ANAHTAR  düğmesine basın. Düğmeleri bırakın ( <b>7</b> &  )		<b>Kırmızı</b> ve <b>Yeşil</b> LED değişken biçimde yanıp sönüyor
2. 10 saniye içinde <b>9</b> (wxyz) düğmesine üç kez (üçlü tıklatma) ( <b>999</b> ) basın		<b>Kırmızı</b> ve <b>Yeşil</b> LED değişken biçimde yanıp sönmeye devam eder
3. <b>7</b> (pqrs) düğmesine basılı tutun ve daha sonra ANAHTAR  düğmesine basın. Düğmeleri bırakın ( <b>7</b> &  )		<b>Red</b> LED olarak kapanır ve sıfırlama işleminin tamamlandığını gösterir

## 13. DT2000'nin Windows İşletim Sisteminde yapılandırılması

Arka arkaya **10 kez yanlış PIN** girilmesi nedeniyle korsanlık algılaması devreye girdiğinde ya da sürücü sıfırlandığında, **sürücü üzerindeki verilerin tümü geri alınamayacak biçimde silinir**.

Yeni **Kullanıcı PIN**'i oluşturulduktan sonra DT2000'nin başlatılması ve biçimlendirilmesi gerekmektedir.

### DT2000'nizi başlatmak için aşağıdaki işlemleri yapın:

1. Yeni bir **Kullanıcı PIN**'i oluşturun (bkz. bölüm 4).
2. Yeni **Kullanıcı PIN**'ini girerek DT2000'in kilidini açın ve bilgisayarın USB bağlantı noktasına takın.
3. Bilgisayar, kullanıcıya aşağıdaki mesajı vermelidir:

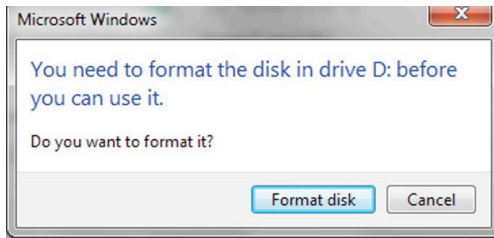

4. **Format disk**'i (Diski biçimlendir) tıklararak devam edin. Gereksinimlerinize göre **FAT32** ya da **NTFS** seçin, bir **Volume Label** (Birim etiketi) girin **Start**'ı (Başlat) seçin.

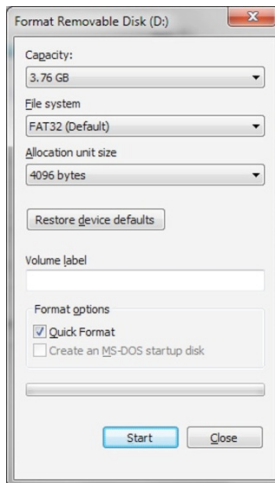

5. Sürücüyü biçimlendirmeye devam etmek için **OK**'i (Tamam) tıklayın.

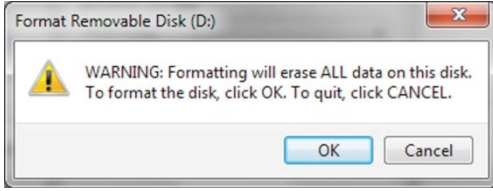

**Uyarı:** Bu işlem, sürücüdeki **tüm verileri** silecektir.

6. Bilgisayar sürücünün biçimlendirmesini tamamlayacak ve biçimlendirmenin tamamlandığını onaylayacaktır. DT2000 biçimlendirilirken **Mavi** LED yanıp söner.

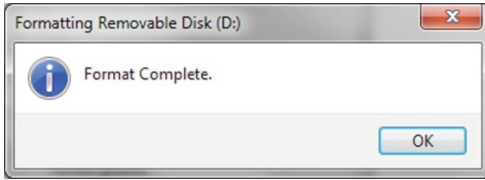

Tamamlandığında **Mavi** LED sürekli yanar ve DT2000'iniz kullanıma hazırdır.

**Eğer biçimlendirme sihirbazı görünmüyorsa lütfen aşağıdaki işlemleri yapın:**

1. **My Computer** (Bilgisayarım) ya da **Computer**'i (Bilgisayar) sağ tıklayın ve daha sonra **Manage**'i (Yönet) tıklayın.
2. **Computer Management** (Bilgisayar Yönetimi) penceresinde **Disk Management** (Disk Yönetimi) sekmesinde, DT2000 biçimlendirilmemiş formatta bir çıkartılabilir cihaz olarak algılanır.

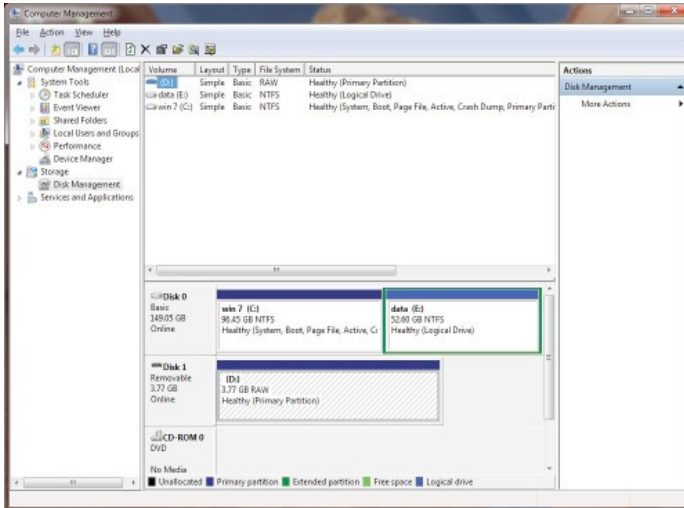

3. Ayrılmamış bölümün altındaki boş alanda **Removable Raw Drive**'i (Çıkarılabilir Biçimlendirilmemiş Sürücü) sağ tıklatın ve **Format**'i (Biçimlendir) seçin.

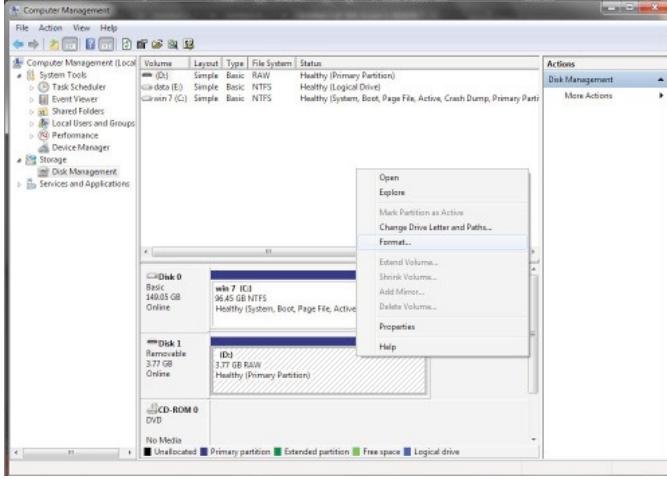

4. **Format** (Biçimlendirme) penceresi açılır. Yeni bir **Volume Label** (Birim Etiketi) girin. Gereksinimlerinize göre **FAT32** ya da **NTFS** seçin ve **OK**'i (Tamam) tıklatın.

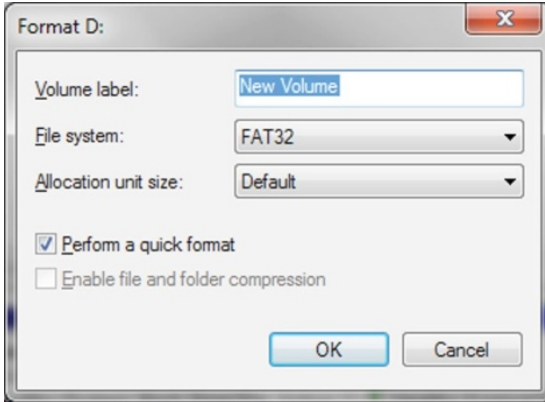

5. Devam etmek için **Format** (Biçimlendirme) uyarı penceresinde **OK**'e (Tamam) basın.

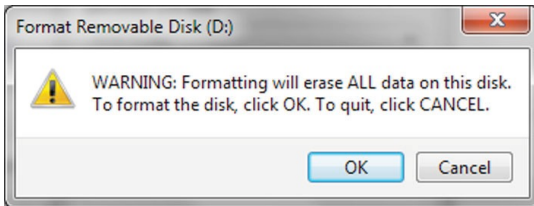

**Uyarı:** Bu işlem, sürücüdeki **tüm verileri** silecektir.

6. Bilgisayar biçimlendirmeyi tamamlayacak ve **Disk Management** (Disk Yönetimi) penceresine geri dönecektir.

DT2000 biçimlendirilirken **Mavi** LED yanıp sönmeye başlayacaktır.

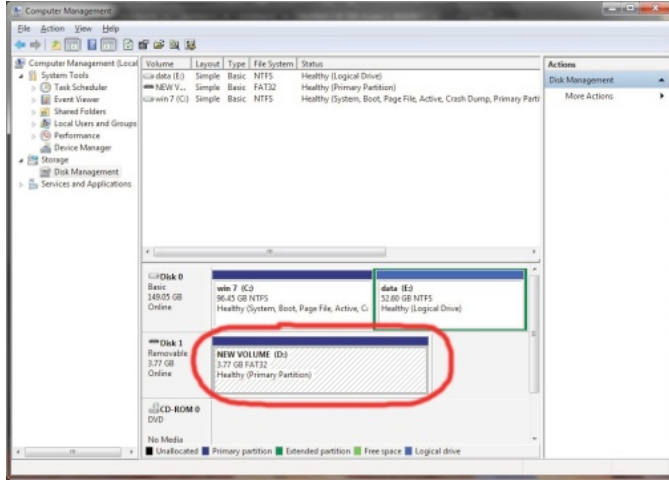

Tamamlandığında **Mavi** LED sürekli yanar ve DT2000'iniz kullanıma hazırdır.

## 14. DT2000'nin MAC İşletim Sisteminde yapılandırılması

Arka arkaya 10 kez yanlış PIN girilmesi nedeniyle korsanlık algılaması devreye girdiğinde ya da sürücü sıfırlandığında, **sürücü üzerindeki verilerin tümü geri alınamayacak biçimde silinir.**

Yeni **Kullanıcı PIN**'i oluşturulduktan sonra DT2000'nin başlatılması ve biçimlendirilmesi gerekmektedir.

DT2000'nizi Mac İşletim Sistemi kullanan bilgisayarlarda biçimlendirmek için aşağıdakileri yapın:

1. Yeni bir **Kullanıcı PIN**'i oluşturun (bkz. bölüm 4).
2. Yeni **Kullanıcı PIN**'ini girerek DT2000'in kilidini açın ve Mac bilgisayarın USB bağlantı noktasına takın. Sistemde **INITIALIZE** (BAŞLAT) penceresi açılacaktır.

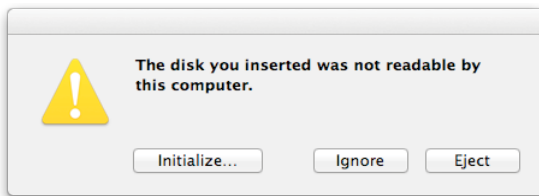



3. **INITIALIZE**'ye (BAŞLAT) basın ve **Disk Utility** (Disk Uygulaması) penceresinde DT2000'i seçin.

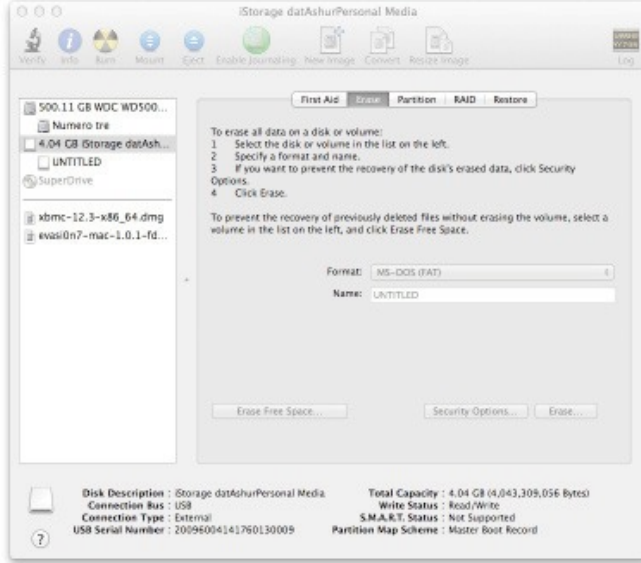

4. **Disk Utility** (Disk Uygulaması) penceresinin sol tarafında DT2000'i tıklatın.
5. Pencerenin sağ tarafındaki bağlam menüsünden **Erase**'yi (Sil) seçin.
- Volume Format** (Birim Biçimi) kısmında **MS-DOS**'u seçin.
6. **Erase**'yi (Sil) tıklatın.

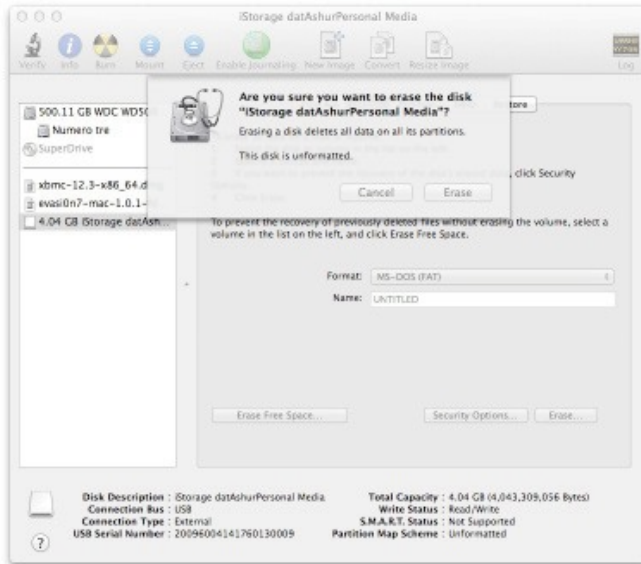

7. Biçimlendirilmiş DT2000 **Disk Utility** (Disk Uygulaması) penceresinde görüntülenir ve masaüstünde kullanılabilir duruma gelir.

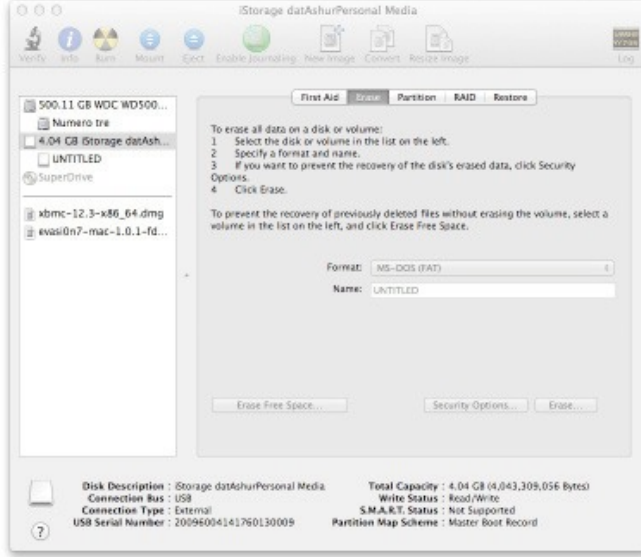

## Pil Bilgileri / Ürünün Atılması

Lütfen elektrikli ya da pil içeren ürün atıklarını, normal evsel atıklarla birlikte atmayın. Çevresel etkileri en aza indirmek için elektronik ürünlerinizi sorumlu biçimde atılması gerekmektedir. Lütfen pilli üründen çıkartmaya çalışmayın, yalnızca Kingston ya da profesyonel bir servis sağlayıcı tarafından çıkartılabilir. Lütfen pil hakkında daha fazla bilgi ve ürünün sorumlu biçimde nasıl geri dönüştürüleceğiyle ilgili daha fazla bilgi için bizimle [iletişim](#) kurun.

DataTraveler® 2000'de lisansı ClevX, LLC'ye ait DataLock® Teknolojisi bulunmaktadır.

## DataTraveler® 2000 - ユーザーマニュアル



お手元の PIN 番号は、安全な場所に保管してください。PIN 番号を紛失または忘れてしまった場合、Kingston DataTraveler® に保存したデータ にアクセスできなくなります。

問題がある場合は、DT2000  
に同梱されたユーザーガイドを参照してください。また当社の Web  
サイト：[kingston.com/support](http://kingston.com/support) から入手できます。

DataTraveler® 2000 には、ClevX, LLC 社からライセンス契約を受けた DataLock® Technology が内蔵されています。

©2016 Kingston Technology Far East Co. Ltd (Asia Headquarters) No. 1-5, Li-Hsin Rd. 1, Science Park, Hsin Chu, Taiwan, R.O.C. All rights reserved.

## 目次

システム要件.....	3
はじめに.....	4
1. DT2000 のレイアウト.....	5
2. LED インジケータとその機能.....	5
3. 初めて DT2000 を使用方法.....	6
4. ユーザ PIN の変更方法.....	6
5. オプションを有効にする方法.....	7
6. 読取り専用モードを有効にする方法.....	8
7. 読取り/書込みモードを有効にする方法.....	8
8. タイムアウトロックモードの設定方法.....	9
9. タイムアウトロックモードの解除方法.....	9
10. DT2000 のバージョン番号の確認方法.....	10
11. ブルートフォースハッキングの検出.....	10
12. DT2000 のリセット方法.....	11
13. Windows OS で DT2000 を構成する方法.....	12
14. Mac OS で DT2000 を構成する方法.....	15

## 本書について

このユーザーズガイドは、Kingston 製 DataTraveler<sup>®</sup> 2000（以下、DT2000 呼びます）用のものです。

## システム要件

---

### PC プラットフォーム

#### 対応オペレーティングシステム (OS)

- Windows 10
  - Windows 8/8.1
  - Windows 7
  - Windows Vista<sup>®</sup> (SP2)
- 

### Mac プラットフォーム

#### 対応オペレーティングシステム (OS)

- Mac OS X 10.8.x - 10.11x
- 

### Linux プラットフォーム

#### 対応オペレーティングシステム (OS)

- Linux v2.6 カーネル+
- 

### その他のプラットフォーム

#### 対応オペレーティングシステム (OS)

- Chrome OS<sup>™</sup>, Android\*
- 

\*互換デバイスのみ。USB フラッシュドライブのサポートの有無を確認するには、お手元のデバイスのメーカーにご確認ください。

## はじめに



**注意:** DT2000 の充電式バッテリーは、箱から出してフル充電は行われておりません。最初にご使用になる前に、バッテリーを充電するように推奨します。バッテリーを充電するには、DT2000 を電源付きの USB ポートに 60 分間接続して、バッテリーをフル充電してください。

当製品をお買い上げ頂き、有り難うございます。DataTraveler<sup>®</sup> 2000 は、非常に安全で使いやすいハードウェア暗号化処理を行う USB 3.0 PIN 起動のフラッシュドライブです。

DT2000 は軍用グレードの XTS-AES 256 ビットハードウェア暗号化処理を行うもので、フラッシュドライブに保存するすべてのデータをリアルタイムで暗号化します。DT2000 の動作にソフトウェアや OS は必要なく、またホストとも独立しています。

DT2000 には充電式バッテリーが内蔵されており、ユーザはフラッシュドライブを USB ポートに接続する前に、7~15 桁の PIN（個人識別番号）を搭載されている 10 キーパッドで入力できます。

フラッシュドライブが紛失/盗難に遭った場合でも、DT2000 に保存されたすべてのデータは安全な状態で、認証されていない人がアクセスすることはできません。

DT2000 のロック解除は、搭載された 10 キーパッドから行うことができ、ホストコンピュータからは解除できません。ソフトウェア/ハードウェアベースのキーロガーや、ブルートフォース攻撃に対する脆弱性はありません。









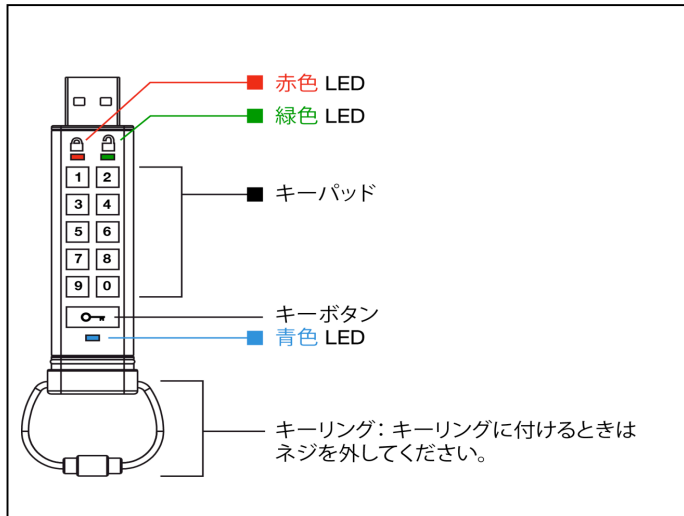







**注意:** DT2000 にはデフォルトの PIN が同梱されています。ユーザ PIN は、次の通りです。🔑 1-1-2-2-3-3-4-4 🔑 デフォルト PIN を使って、ボックスから直接取り出して使用できますが、安全上の理由から、本書の第 4 章「ユーザ PIN の変更方法」に示された指示に従って、直ちに新しい PIN を作成するように強く推奨します。

ユーザが PIN を忘れた場合、すべてのデータにアクセスできなくなります。

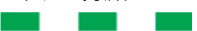
## 1. DT2000 のレイアウト





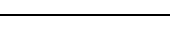

## 2. LED インジケータとその機能

LED	LED の状態	説明	LED の状態	説明	説明
	<b>赤 黒</b> フェードアウト 	ロックダウン/誤った PIN 入力		<b>赤 と 緑</b> が交互に明滅 	出荷時にリセット
	<b>赤</b> の明滅 	ロック状態になり、工場出荷時のデフォルト PIN または定義済みの PIN 入力を待つ			
	<b>緑</b> の点灯が継続 	DT2000 は非ロック状態です		<b>緑 と 青</b> が共に明滅 	ユーザオプションモード
	<b>緑</b> が点滅 	USB ポートに接続し、 <b>緑</b> の LED が 2 秒毎に点滅する場合は、DT2000 が「読み取り専用」に設定されていることを示します。			
	<b>青</b> の点灯が継続 	USB ポートに接続されている			
	<b>青</b> の明滅 	ホストとのデータ交換/ユーザ PIN の変更中			

### 3. 初めて DT2000 を使用する方法

DT2000 には、“11223344” というデフォルト PIN が同梱されています。デフォルト PIN を使って、ボックスから直接取り出して使用できますが、安全上の理由から、本書の第 4 章「ユーザ PIN の変更方法」に示された指示に従って、直ちに新しい PIN を作成するように強く推奨します。

デフォルト PIN で DT2000 のロックを解除するには、以下の表の 3 つのステップを行ってください。

指示手順（最初にのみ使用）	LED	LED の状態
1. [KEY] ボタンを 1 回、押す。 		赤、緑 および 青 の LED が同時に一度点灯した後、赤 の LED の明滅が続きます。
2. 10 秒以内に、ユーザ PIN（デフォルト値は、11223344）を入力して、ロックを解除する。 DT2000		赤 の LED が明滅を続けます。
3. [KEY] ボタンを 1 回、押す。 		赤 で連続点灯の LED が、緑 の連続点灯に変わり、デフォルト（省略時値）のユーザ PIN が正しく入力されたことを示します。



**注：** DT2000 のロック解除が正常に行われると、緑の LED が点灯状態になりますので、30 秒以内に DT2000 を USB ポートに接続する必要があります。これは [KEY] ボタン  を 30 秒間長押しすればロックダウンできます。30 秒間何もしなければ時間切れとなり、またお手元の OS 内で「ハードウェアを安全に取り外してメディアを取り出す」アイコンをクリックしてロックダウンできます。

### 4. ユーザ PIN の変更方法

PIN の要件：

- 番号の長さは、7～15 桁でなければなりません
- 繰り返し番号のみ、例えば (3-3-3-3-3-3)、を含めることはできません
- 連続した番号のみ、例えば (1-2-3-4-5-6-7)、(7-8-9-0-1-2-3-4)、または (7-6-5-4-3-2-1)、を含めることはできません









**パスワードのヒント：** 単に関連する文字のキーを押して、記憶に残るような単語、名前、フレーズ（言い回し）、あるいは他の英数字を組み合わせた PIN を作成できます。

これらのタイプの英数字の PIN には、以下のような例があります。

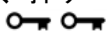
- “password” の場合、以下のキーを押します：  
7 (pqrs) 2 (abc) 7 (pqrs) 7 (pqrs) 9 (wxyz) 6 (mno) 7 (pqrs) 3 (def)
- “kingston” の場合、以下のキーを押します：  
5 (jkl) 4 (ghi) 6 (mno) 4 (ghi) 7 (pqrs) 8 (tuv) 6 (mno) 6 (mno)

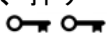
この方法を使って、長い間、そして簡単に思い出すことができる PIN を作成できます。



手順	LED	LED の状態
1. [KEY] ボタンを 1 回、押す。 		赤、緑 および 青 の LED が同時に一度点灯した後、赤 の LED の明滅が続きます。
2. 10 秒以内に、ユーザ PIN（デフォルト値は、11223344）の入力を開始して、DT2000のロックを解除する。		赤 の LED が明滅を続けます。
3. [KEY] ボタンを 1 回、押す。 		赤 で連続点灯の LED が、緑 の連続点灯に変わり、デフォルト（省略時値）のユーザ PIN が正しく入力されたことを示します。
4. [KEY] ボタンを 2 回、押す（ダブルクリック） 		青 の LED が明滅します
5. 10 秒以内に、新しいユーザ PIN の入力を開始する		青 の LED の明滅が続きます
6. [KEY] ボタンを 2 回、押す（ダブルクリック） 		緑 の LED が明滅します
7. 10 秒以内に、新しいユーザ PIN の再入力を開始する		緑 の LED の明滅が続きます
8. [KEY] ボタンを 2 回、押す（ダブルクリック） 		赤 で連続点灯の LED が、緑 の連続点灯に変わり、ユーザ PIN が正しく変更されたことを示します



**注：**新しいユーザ PIN の定義時、または手順の完了前にミスが行われた場合、フラッシュドライブは古い PIN を保持します。

## 5. オプションを有効にする方法





以下の表は「オプションモード」へのアクセス方法を示し、セクション6~9では各種機能の実行方法を説明しています。

ユーザは「オプションモード」を選択して、DT2000の「読取り専用」としての設定、「タイムアウト」の自動ロックの設定、およびデバイスのバージョンの判断の有効化または無効化など、各種の機能を行うことができます。

手順	LED	LED の状態
1. [KEY] ボタンを 1 回、押す。 		赤、緑 および 青 の LED が同時に一度点灯した後、赤 の LED の明滅が続きます。
2. 10 秒以内に、ユーザ PIN（デフォルト値は、11223344）を入力して、DT2000のロックを解除する		赤 の LED が明滅を続けます。
3. [KEY] ボタンを 1 回、押す。 		赤 で連続点灯の LED が、緑 の連続点灯に変わり、ユーザ PIN が正しく入力されたことを示します。
4. [KEY] ボタンを 3 回、押す（トリプルクリック） 		緑 と 青 の LED が共に明滅して、「オプションモード」での新たな指示を待ちます。

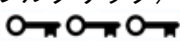
## 6. 読取り専用モードを有効にする方法

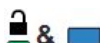
DT2000 は、フラッシュドライブへの書き込みアクセスを制限する「読取り専用モード」を持っています。これは、以下の手順を行うことによって有効になります。

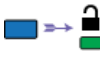
手順	LED	LED の状態
1. ユーザ PIN を入力して、DT2000 のロックを解除する		赤で連続点灯の LED が、緑の連続点灯に変わり、ユーザ PIN が正しく入力されたことを示します。
2. [KEY] ボタンを 3 回押して (トリプルクリック)、オプションを有効にする 		緑と青の LED が共に明滅して、「オプションモード」での新たな指示を待ちます。
3. 10 秒以内に「7」(pqrs) を押し、その後「6」(mno) のボタンを押す (76)		緑と青の LED が共に明滅を続けます
4. [KEY] ボタンを 1 回、押す。 		青の LED が消えて、緑が点灯し、DT2000 を USB ポートに挿入すると、緑の LED が 2 秒間隔で明滅し、フラッシュドライブが読取り専用モードになったことを示します





一度アクティブ化すると、書き込み保護が無効になるまで、アクセスは「読取り専用」に制限されます。

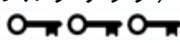

**注：** 各オプション設定でユーザが入力値を簡単に思い出すことができるように、命名規則を適用しています。上記の表では、オプションの機能名の「最初の文字」を表す番号を使用しています。たとえば、Read-Only = 7 (pqrs) 6 (mno) です。

## 7. 読取り/書き込みモードを有効にする方法

書き込み保護（読取り専用）のアクセス制限は、アクセスを読取り/書き込み用に戻すことにより解除できます。これは、以下の手順を行うことによって可能です。

手順	LED	LED の状態
1. ユーザ PIN を入力して、DT2000 のロックを解除する		赤で連続点灯の LED が、緑の連続点灯に変わり、ユーザ PIN が正しく入力されたことを示します
2. [KEY] ボタンを 3 回押して (トリプルクリック)、オプションを有効にする 		緑と青の LED が共に明滅して、「オプションモード」での新たな指示を待ちます。
3. 10 秒以内に「7」(pqrs) を押し、その後「9」(wxyz) のボタンを押す (79)		緑と青の LED が共に明滅を続けます
4. [KEY] ボタンを 1 回、押す。 		青の LED が消えて、緑が点灯し、DT2000 を USB ポートに挿入すると、緑の LED が 2 秒間隔で明滅し、フラッシュドライブが読取り専用モードになったことを示します









一度アクティブ化すると、アクセスはデフォルトの「読取り/書き込み」モードに戻ります。

## 8. タイムアウトロックモードの設定方法

DT2000 をホストに接続し、席を離れた時に不正アクセスから保護するために、DT2000 は、あらかじめ設定した時間の経過後に、自動的にロックするように設定できます。









デフォルト設定の場合、DT2000 の「タイムアウトロック」機能はオフになります。「タイムアウトロック」機能は、1～99分間の任意の時間で起動（ロック）するように設定できます。

「タイムアウトロック」を設定する場合は、以下の表の手順に従ってください。







手順	LED	LED の状態
1. ユーザ PIN を入力して、DT2000 のロックを解除する		赤で連続点灯の LED が、緑の連続点灯に変わり、ユーザ PIN が正しく入力されたことを示します
2. [KEY] ボタンを 3 回押して（トリプルクリック）、オプションを有効にする 		緑と青の LED が共に明滅して、「オプションモード」での新たな指示を待ちます。
3. 10 秒以内に「8」(tuv) を入力し、その後に「5」(jkl) ボタンを押す (85)		緑と青の LED が共に明滅を続けます
4. [KEY] ボタンを 1 回、押す。 		緑の LED が明滅します
5. 10 秒以内に、「ユーザタイムアウト」時間を、2桁の数字で入力します： 00 = 0 分（デフォルト値） 01 = 1 分 99 = 99 分（以下省略）		緑の LED の明滅が続きます
6. [KEY] ボタンを 1 回、押す。 		緑の LED が点灯し、「タイムアウトロック」機能が有効になりました

## 9. タイムアウトロックモードの解除方法

「タイムアウトロック」を無効にする場合は、以下の表の手順に従ってください。

手順	LED	LED の状態
1. ユーザ PIN を入力して、DT2000 のロックを解除する		赤で連続点灯の LED が、緑の連続点灯に変わり、ユーザ PIN が正しく入力されたことを示します
2. [KEY] ボタンを 3 回押して（トリプルクリック）、オプションを有効にする 		緑と青の LED が共に明滅して、「オプションモード」での新たな指示を待ちます。
3. 10 秒以内に「8」(tuv) を入力し、その後に「5」(jkl) ボタンを押す (85)		緑と青の LED が共に明滅を続けます
4. [KEY] ボタンを 1 回、押す。 		緑の LED が明滅します
5. 10 秒以内に「0」ボタンを 2 回押します（ダブルクリック）(zero zero) - (00)		緑の LED の明滅が続きます
6. [KEY] ボタンを 1 回、押す。 		緑の LED が点灯し、「タイムアウトロック」が無効になりました

## 10. DT2000 のバージョン番号の確認方法

手順	LED	LED の状態
1. ユーザ PIN を入力して、DT2000 のロックを解除する		<b>赤</b> で連続点灯の LED が、 <b>緑</b> の連続点灯に変わり、ユーザ PIN が正しく入力されたことを示します
2. [KEY] ボタンを 3 回押して (トリプルクリック)、オプションを有効にする 		<b>緑と青</b> の LED が共に明滅して、「オプションモード」での新たな指示を待ちます。
3. 10 秒以内に「8」 (tuv) を入力し、その後「6」 (mno) ボタンを押す - (86)		<b>緑と青</b> の LED が共に明滅を続けます
4. [KEY] ボタンを 1 回、押す。 	 	<b>赤、緑</b> および <b>青</b> の LED が同時に一度点灯した後、 <b>赤</b> の LED の明滅が続き、レビジョンの最初の有意な桁が示されます。次に、 <b>緑</b> の LED が明滅して、レビジョン番号の 2 番目の有意な桁が示されます
例えば、レビジョン番号が「1.8」の場合、 <b>赤</b> の LED が一度明滅し、次に <b>緑</b> の LED が 8 回明滅します。この流れが終わると、 <b>赤、緑</b> および <b>青</b> の LED が同時に一度点灯した後、 <b>緑</b> の LED の点灯が続きます。		

## 11. ブルートフォースハッキングの検出



**注意：** ユーザが間違っただユーザー PIN を 10 回ほど続けて入力した場合、DT2000 のブルートフォースメカニズムが起動して、ユーザー PIN、暗号化キー、およびすべてのデータが削除され、永久に失われます。

DT2000 のロック解除に使用される PIN	10 回続けて間違っただ PIN を入力した場合、何が起こりますか？
ユーザー PIN	DT2000 のブルートフォースメカニズムが起動して、ユーザー PIN、暗号化キー、およびすべてのデータが削除され、永久に失われます。

ユーザーが間違っただ PIN を 10 回ほど続けて入力した場合、ユーザー PIN、暗号化キー、およびすべてのデータが削除され、永久に失われます。その後、DT2000 は工場出荷時の設定状態に戻り、ユーザー PIN は「11223344」に設定されます。ユーザー PIN の変更方法に関しては、6 ページのセクション 4 を参照してください。またこれは、新しい暗号化キーの作成を強制的に行うため、DT2000 の再フォーマットが必要になります (セクション 13 または 14 を参照)。

他の同様のドライバとは異なり、DT2000 には乱数ジェネレータが組み込まれています。フラッシュドライブを一度リセットすると、新しい暗号化キーがランダムに生成されます。

## 12. DT2000 のリセット方法

ユーザ PIN を忘れてしまった場合、またはユーザが FT2000 に保存した全データを削除したい場合は、以下の手順に従ってください。

リセットプロセスを行うと、ユーザ PIN を含むすべての暗号パラメータが消去されます。これは DT2000 が、デフォルトのユーザ PIN、すなわち 11223344 に戻されることを意味します。ユーザ PIN の変更方法は、6 ページのセクション 4 を参照してください。またこれは、新しい暗号化キーの作成を強制的に行うため、DT2000 の再フォーマットが必要になります（セクション 13 または 14 を参照）。



**注意**： DT2000 をリセットすると、フラッシュドライブに保存されている全データが削除されます。

手順	LED	LED の状態
1. 「7」 (pqrs) ボタンを長押しし、次に KEY  ボタンを押します。ボタンから指を離す (7 &  )	 / 	赤と緑の LED が交互に明滅します
2. 10 秒以内に「9」 (wxyz) のボタンを 3 回押す (トリプルクリック) (999)	 / 	赤と緑の LED が交互に明滅を続けます
3. 「7」 (pqrs) のボタンを長押しし、次に KEY  ボタンを押す。ボタンから指を離す (7 &  )		赤の LED が消え、リセットプロセスが完了します

## 13. Windows OS で DT2000 を構成する方法

間違った PIN を 10 回連続して入力したため、ハッキング検出がトリガーした場合、またはフラッシュドライブがリセットされた場合、**ドライブ内の全データが永久に失われます**。

新しいユーザ PIN を一度作成すると、DT2000 を初期化し、フォーマットする必要があります。

お手元の DT2000 を初期化するには、以下の手順を行ってください。

1. 新しいユーザ PIN を作成する（セクション 4 を参照）。
2. 新しいユーザ PIN を入力して DT2000 のロックを解除し、パソコンの USB ポートに接続する。
3. パソコンからは、以下のメッセージがユーザに対して通知されます：

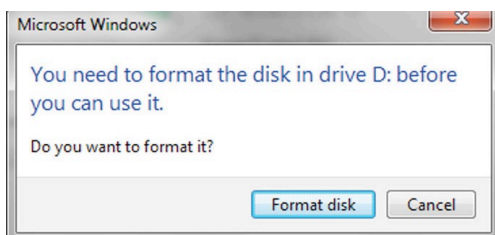

4. [ディスクのフォーマット] をクリックして、次に進む。ユーザの必要性に応じて **FAT32** または **NTFS** を選択する。ボリュームラベルを入力し、[Start] をクリックする。

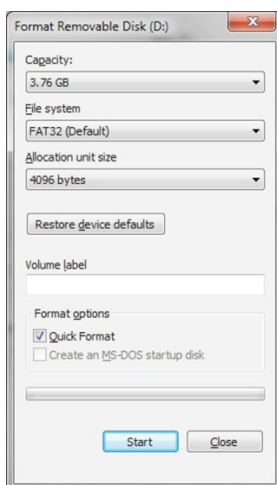

5. [OK] をクリックし、ドライブのフォーマットを行う。



 **警告**：この手順を行うと、ドライブ内の全データが消去されます。

6. パソコンはフラッシュドライブのフォーマットを終了し、フォーマットが完了したことを確認します。DT2000 がフォーマットされている時、青の LED が明滅しています。

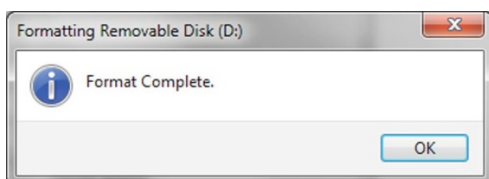

これが終わると、青の LED が点灯状態になり、お手元の DT2000 は使用可能になります。

フォーマットのウィザードが表示されない場合は、以下の手順を行ってください。

1. [マイコンピュータ] または [コンピュータ] を右クリックし、次に [管理] をクリックする。
2. [ディスクの管理] タブの下の [コンピュータの管理] ウィンドウ内で、DT2000 は RAW 形式のリムーバブルデバイスとして認識されます。

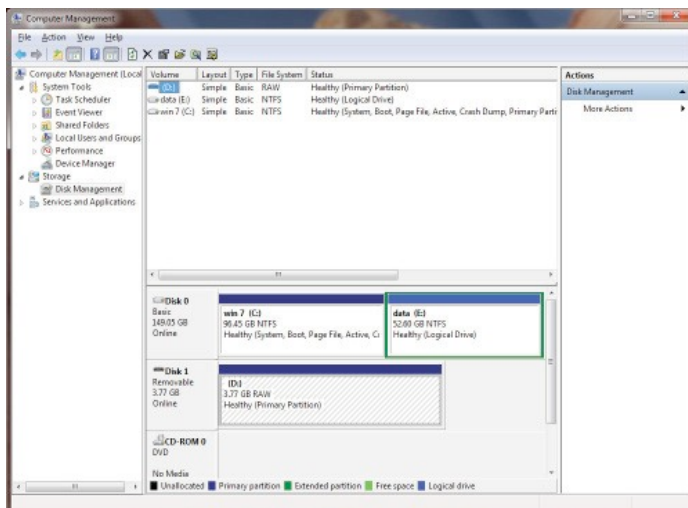

3. 未割当てのセクションの下の空白領域の中で、**[RAW 形式のリムーバブルドライブ]** を右クリックし、**[フォーマット]** を選択する。

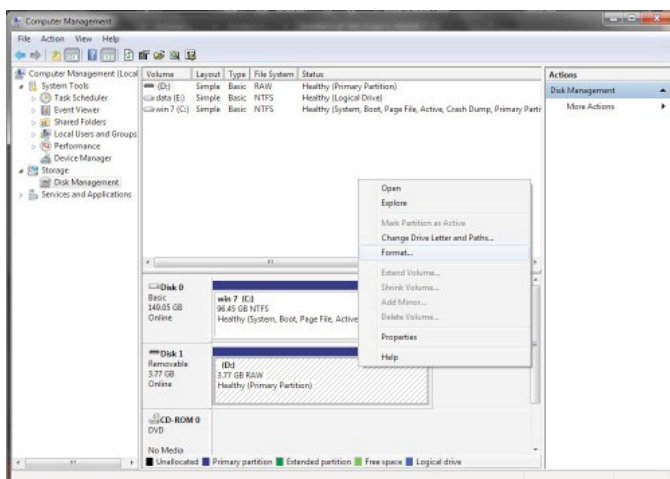

4. **[Format]** ウィンドウが開きます。  
新しい**[ボリュームラベル]** を入力する。  
ユーザの必要性に応じて **[FAT32]** または **[NTFS]** を選択し、**[OK]** をクリックする。

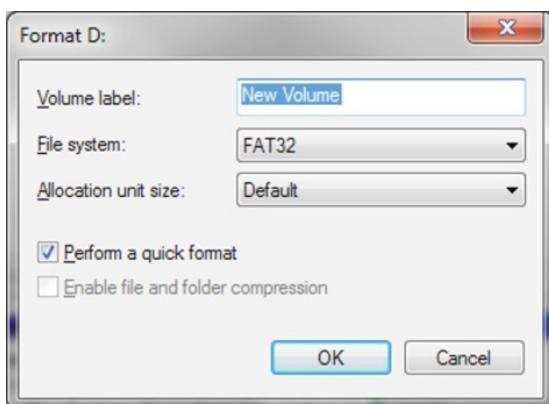

5. **Format** の警告ウィンドウで **[OK]** をクリックして、フラッシュドライブのフォーマットを続ける。

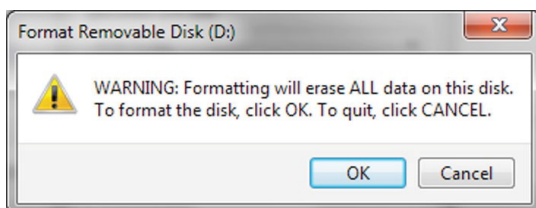

 **警告:** この手順を行うと、ドライブ内の全データが消去されます。



6. パソコンはフォーマットを終了し、[ディスクの管理] ウィンドウに戻ります。

DT2000 がフォーマットされている時、**青**の LED が明滅しています。

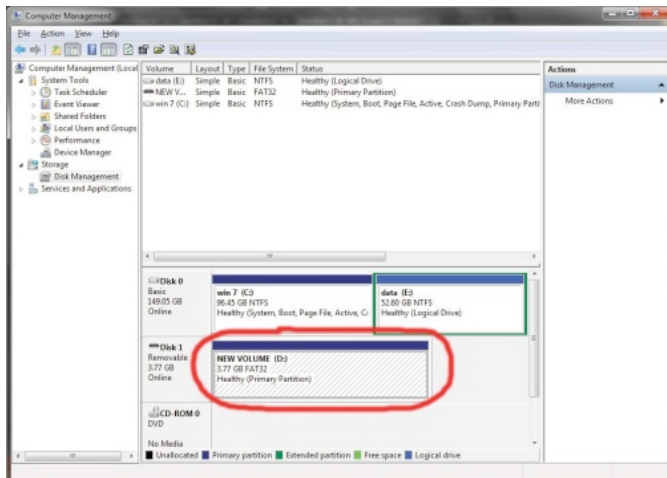

これが終わると、**青**の LED が点灯状態になり、お手元の DT2000 は使用可能になります。

## 14. Mac OS で DT2000 を構成する方法

間違った PIN を 10 回連続して入力したため、ハッキング検出がトリガーした場合、またはフラッシュドライブがリセットされた場合、**フラッシュドライブ内の全データが永久に失われます**。

新しいユーザ PIN を一度作成すると、DT2000 を初期化し、フォーマットする必要があります。

Mac OS パソコン上で お手元の DT2000 をフォーマットするには、以下の手順を行ってください。

1. 新しいユーザ PIN を作成する（セクション 4 を参照）。
2. 新しいユーザ PIN を入力して DT2000 のロックを解除し、Mac パソコンの USB ポートに接続する。システムはユーザに対して [INITIALIZE] ウィンドウを表示して、初期化を求めてきます。

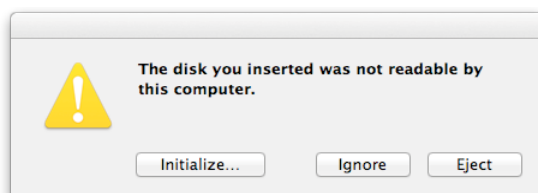

3. [初期化] を押し、[Disk Utility] ウィンドウ内で DT2000 を選択する。

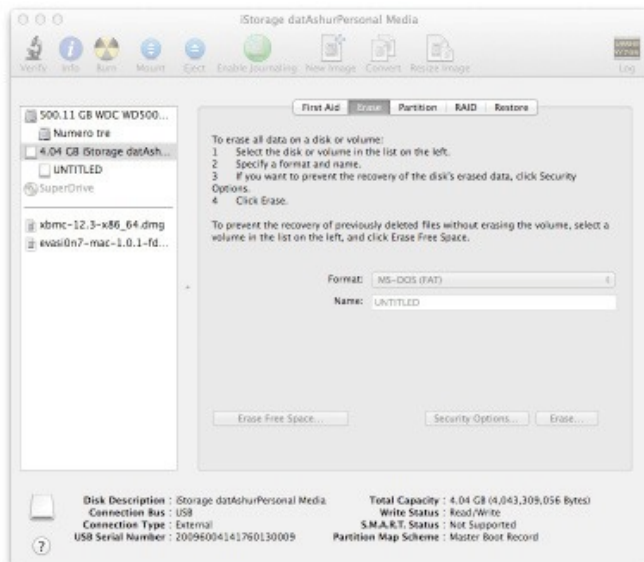

4. [Disk Utility] ウィンドウの左側で、DT2000 をクリックする。
5. ウィンドウの右側のコンテキストメニューから、[消去] を選ぶ。  
[ボリュームフォーマット] に対して、**MS-DOS** を選択する。
6. [消去] をクリックする。

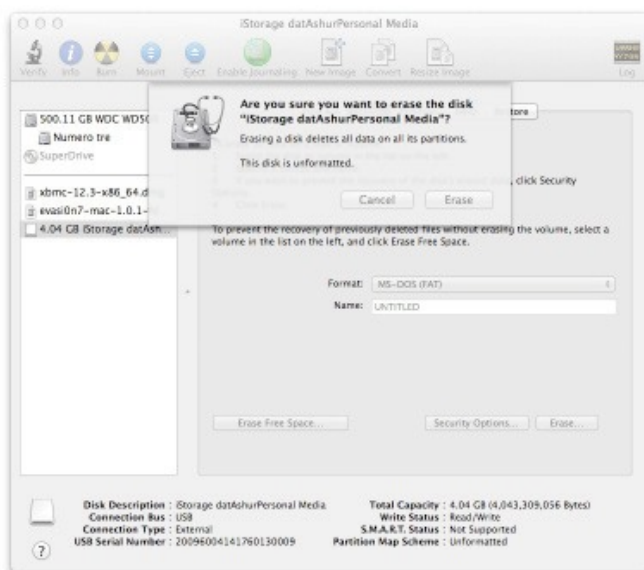

7. フォーマット済みの DT2000 が [ディスクユーティリティ] ウィンドウに表示され、デスクトップにマウントされます。

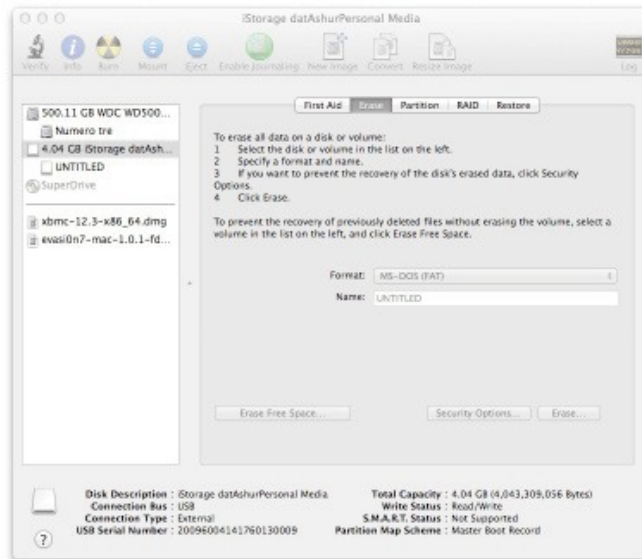

## バッテリーについてのお知らせ/製品の廃棄について

製品廃棄物を含む電気製品やバッテリーを、通常の家庭ゴミとして処分しないでください。電気製品は、環境への影響を最小限にするように、責任を持って処分しなければなりません。処分する製品からバッテリーを取り出したりしないでください。このような作業は、Kingston社または専門のサービス・プロバイダのみが実施可能です。バッテリーに関する詳細や、責任を持って製品をリサイクルする方法については、当社に [お問い合わせ](#) ください。

DataTraveler® 2000 には、ClevX, LLC 社からライセンス契約を受けた DataLock® Technology が内蔵されています。

## DataTraveler® 2000 - คู่มือผู้ใช้



**กรุณาเก็บ PIN ของคุณไว้ในที่ปลอดภัย หากสูญหายหรือลืม จะไม่สามารถสืบค้นข้อมูลที่จัดเก็บใน Kingston DataTraveler® ได้**

หากมีปัญหา กรุณาตรวจสอบรายละเอียดในคู่มือผู้ใช้อย่างละเอียดสำหรับ DT2000 ชุดนี้ หรือเข้าไปที่เว็บไซต์ของ Kingston ที่: [kingston.com/support](http://kingston.com/support)

DataTraveler® 2000 เลือกใช้เทคโนโลยี DataLock® จาก ClevX, LLC.

©2016 Kingston Technology Corporation, 17600 Newhope Street, Fountain Valley, CA 92708 USA.

สงวนลิขสิทธิ์ เครื่องหมายการค้าและเครื่องหมายการค้าจดทะเบียนทั้งหมดถือเป็นกรรมสิทธิ์ของเป็นเจ้าของ

## สารบัญ

เงื่อนไขทางระบบ .....	3
เกริ่นนำ .....	4
1. คำโครงของ DT2000 .....	5
2. ไฟ LED และการทำงาน.....	5
3. การใช้ DT2000 ครั้งแรก .....	6
4. การเปลี่ยน PIN ผู้ใช้.....	6
5. การเปิดใช้งานตัวเลือกต่าง ๆ.....	7
6. การเปิดใช้โหมดอ่านอย่างเดียว .....	7
7. การเปิดใช้โหมดอ่าน/เขียน .....	8
8. การกำหนดโหมดล๊อคเมื่อเกินเวลาที่กำหนด .....	9
9. การปิดโหมดล๊อคเมื่อเกินเวลาที่กำหนด .....	9
10. การตรวจสอบเลขเวอร์ชันของ DT2000 .....	10
11. ระบบตรวจจับการแฮ็คแบบเจตนา .....	10
12. การรีเซ็ต DT2000.....	11
13. การกำหนดค่า DT2000 กับ Windows OS .....	12
14. การกำหนดค่า DT2000 กับ Mac OS .....	15

## เกี่ยวกับคู่มือฉบับนี้

คู่มือผู้ใช้ชุดนี้จัดทำขึ้นสำหรับ DataTraveler® 2000 จาก Kingston (อ้างเป็น DT2000 จากจุดนี้เป็นต้นไป)

## เงื่อนไขทางระบบ

### ระบบ PC

### การรองรับระบบปฏิบัติการสำหรับ PC

- Windows 10
- Windows 8/8.1
- Windows 7
- Windows Vista® SP2

### ระบบ Mac

### ระบบปฏิบัติการที่รองรับ

- Mac OS X 10.8.x - 10.11x

### ระบบ Linux

### ระบบปฏิบัติการที่รองรับ

- Linux v2.6 kernel+

### สถาปัตยกรรมอื่น ๆ

### การรองรับระบบปฏิบัติการ

- Chrome OS™, Android\*

\*เฉพาะอุปกรณ์ที่รองรับเท่านั้น ตรวจสอบกับผู้ผลิตอุปกรณ์ว่ารองรับแฟลชไดรฟ์ USB หรือไม่

## เกริ่นนำ



**หมายเหตุ:** แบตเตอรี่ DT2000 แบบชาร์จไฟได้ไม่ได้ชาร์จมาให้ในตอนเริ่มต้น แนะนำให้ชาร์จแบตเตอรี่ก่อนใช้งานเป็นครั้งแรก ชาร์จไฟโดยเสียบ DT2000 เข้ากับพอร์ต USB ที่มีไฟเลี้ยงเป็นเวลา 60 นาทีเพื่อให้แบตเตอรี่ชาร์จไฟจนเต็ม

ขอขอบคุณที่จัดซื้อ DataTraveler® 2000 แฟลชไดรฟ์ความปลอดภัยสูงพิเศษ พร้อม USB 3.0 PIN เข้ารหัสระดับฮาร์ดแวร์ที่ใช้งานได้ง่าย



DT2000 ใช้ระบบเข้ารหัสฮาร์ดแวร์ XTS-AES 256 บิตที่ใช้ด้านการทหาร โดยจะเข้ารหัสข้อมูลทั้งหมดที่จัดเก็บไว้ในไดรฟ์แบบเรียลไทม์ DT2000 ไม่ต้องอาศัยซอฟต์แวร์ใด ๆ และไม่ขึ้นอยู่กับ OS หรืออุปกรณ์โฮสต์

DT2000 มีแบตเตอรี่ชาร์จไฟในตัว ผู้ใช้จึงสามารถกรอก PIN (เลขรหัสประจำตัว) 7-15 ตัวที่เป็นพิมพ์อ่อนบอร์ดได้ก่อนทำการเชื่อมต่อไดรฟ์กับพอร์ต USB

หากไดรฟ์สูญหายหรือถูกขโมย ผู้ใช้มั่นใจได้ว่าข้อมูลทั้งหมดใน DT2000 จะปลอดภัยและไม่สามารถสืบค้นโดยบุคคลที่ไม่ได้รับอนุญาต

DT2000 จะปลดล็อคผ่านแป้นพิมพ์อ่อนบอร์ด ไม่สามารถปลดล็อคจากคอมพิวเตอร์โฮสต์ได้ อุปกรณ์ไม่ได้รับผลกระทบใด ๆ จากระบบล็อกอินซอฟต์แวร์/ฮาร์ดแวร์ หรือการเจตนาถูกล้างเพื่อพยายามเจาะข้อมูล



**ข้อควรระวัง:** DT2000 มาพร้อมกับ PIN เริ่มต้นคือ PIN ผู้ใช้คือ  1-1-2-2-3-3-4-4 







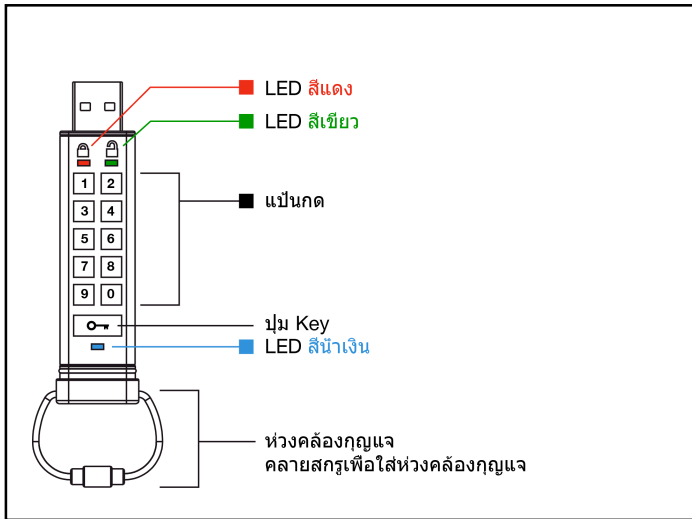







แม้ว่าจะสามารถใช้งานได้ทันทีตั้งแต่แกะกล่องโดยอาศัย PIN เริ่มต้น เพื่อความปลอดภัย เราขอแนะนำให้ใช้ PIN ผู้ใช้ที่จัดทำขึ้นใหม่ในทันที โดยทำตามคำแนะนำในหัวข้อที่ 4 “การเปลี่ยน PIN ผู้ใช้”

หากคุณลืม PIN ข้อมูลทั้งหมดจะไม่สามารถสืบค้นได้

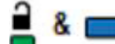
## 1. คำโครงของ DT2000

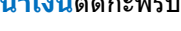

## 2. ไฟ LED และการทำงาน

LED	สถานะ LED	รายละเอียด	สถานะ LED	รายละเอียด	รายละเอียด
	<b>แดง</b> ดำ จางออก 	การลือระบบ/กรอก PIN ไม่ถูกต้อง		<b>แดง</b> และ <b>เขียว</b> กะพริบสลับกัน 	รีเซ็ตเป็นค่าจากโรงงาน
	<b>แดง</b> ติดกะพริบ 	ลือการทำงานและรอ PIN เริ่มต้นจากโรงงานหรือต้องกรอก PIN ที่กำหนด			
	<b>เขียว</b> ติดค้าง 	ปลดลือค DT2000 แล้ว		<b>เขียว</b> และ <b>น้ำเงิน</b> ติดกะพริบพร้อมกัน 	โหมดตัวเลือกผู้ใช้
	<b>เขียว</b> ติดกะพริบ 	ขณะต่อกับพอร์ต USB หาก LED <b>สีเขียว</b> ติดกะพริบทุก ๆ 2 วินาที แสดงว่า DT2000 ถูกตั้งค่าเป็นแบบ "อ่านอย่างเดียว"			
	<b>น้ำเงิน</b> ติดค้าง 	เชื่อมต่ออยู่กับพอร์ต USB			
	<b>น้ำเงิน</b> ติดกะพริบ 	กำลังแลกเปลี่ยนข้อมูลกับโฮสต์/เปลี่ยน PIN ผู้ใช้			



### 3. การใช้ DT2000 ครั้งแรก

DT2000 มาร่วมกับ PIN เริ่มต้นคือ 11223344 แม้ว่าจะสามารถใช้ได้ทันทีตั้งแต่แกะกล่องผ่าน PIN เริ่มต้น แต่เพื่อความปลอดภัย แนะนำให้กำหนด PIN ใหม่ทันทีตามคำแนะนำในข้อ 4 การเปลี่ยน PIN ผู้ใช้

กรุณาทำตามขั้นตอนง่าย ๆ 3 ขั้นตอนในตารางด้านล่างเพื่อปลดล็อค DT2000 โดยใช้ PIN เริ่มต้น

คำแนะนำ (ใช้งานครั้งแรก)	LED	สถานะ LED
1. กดปุ่ม KEY หนึ่งครั้ง 		LED สีแดง เขียว & น้ำเงิน จะติดกะพริบพร้อมกัน หนึ่งครั้ง จากนั้น LED สีแดงจะกะพริบต่อไป
2. ภายใน 10 วินาที ให้กรอก PIN ผู้ใช้ (ค่าเริ่มต้น - 11223344) เพื่อปลดล็อค DT2000		LED สีแดงจะกะพริบต่อไป
3. กดปุ่ม KEY หนึ่งครั้ง 		LED สีแดงที่ติดค้างจะเปลี่ยนเป็น LED สีเขียวติดค้าง เพื่อแจ้งว่ากรอก PIN ผู้ใช้เริ่มต้นเสร็จสิ้น



**หมายเหตุ:** หลังจาก DT2000 ปลดล็อคเสร็จสิ้น LED สีเขียวจะติดค้างเป็นเวลา 30 วินาที ระหว่างนี้จะต้องต่อ DT2000 เข้ากับพอร์ต USB สามารถล็อคการทำงานได้ทันทีโดยกดค้างที่ปุ่ม KEY เป็นเวลา 3 วินาที หรือรอประมาณ 30 วินาทีให้เกินกำหนดเวลา หรือคลิกที่ 'Safely Remove Hardware and Eject Media' icon within your operating system

### 4. การเปลี่ยน PIN ผู้ใช้

เงื่อนไขสำหรับ PIN:













- ยาวระหว่าง 7-15 ตัว
- จะต้องไม่มีแต่ตัวเลขเรียงซ้ำ เช่น (3-3-3-3-3-3-3)
- จะต้องไม่มีแต่ตัวเลขเรียงต่อกัน เช่น (1-2-3-4-5-6-7), (7-8-9-0-1-2-3-4), (7-6-5-4-3-2-1)

**คำแนะนำสำหรับรหัสผ่าน:** คุณสามารถกำหนดค่า ชื่อ วลีหรือ PIN ตัวอักษรและตัวเลขอื่น ๆ ที่จดจำได้โดยการกดปุ่มพร้อมอักขระที่เกี่ยวข้อง

ตัวอย่าง PIN ตัวอักษรและตัวเลขได้แก่

- สำหรับ “รหัสผ่าน” ให้กดปุ่มต่อไปนี้  
7 (pqrs) 2 (abc) 7 (pqrs) 7 (pqrs) 9 (wxyz) 6 (mno) 7 (pqrs) 3 (def)
- สำหรับ “kingston” ให้กด:  
5 (jkl) 4 (ghi) 6 (mno) 4 (ghi) 7 (pqrs) 8 (tuv) 6 (mno) 6 (mno)

วิธีการนี้ทำให้สามารถกำหนด PIN ที่ยาวแต่จดจำได้ง่าย

คำแนะนำ	LED	สถานะ LED
1. กดปุ่ม KEY หนึ่งครั้ง 		LED สีแดง เขียว & น้ำเงิน จะติดกะพริบพร้อมกัน หนึ่งครั้ง จากนั้น LED สีแดงจะกะพริบต่อไป
2. ภายใน 10 วินาที ให้เริ่มกรอก PIN ผู้ใช้ (ค่าเริ่มต้น - 11223344) เพื่อปลดล็อค DT2000		LED สีแดงจะกะพริบต่อไป
3. กดปุ่ม KEY หนึ่งครั้ง 		LED สีแดงที่ติดค้างจะเปลี่ยนเป็น LED สีเขียวติดค้างเพื่อแจ้งว่ากรอก PIN ผู้ใช้เริ่มต้นเสร็จสิ้น
4. กดปุ่ม KEY สองครั้ง (ดับเบิลคลิก) 		LED สีน้ำเงินติดกะพริบ
5. ภายใน 10 วินาที ให้เริ่มกรอก PIN ผู้ใช้ใหม่		LED สีน้ำเงินจะเริ่มติดกะพริบ
6. กดปุ่ม KEY สองครั้ง (ดับเบิลคลิก) 		LED สีเขียวติดกะพริบ
7. ภายใน 10 วินาที ให้เริ่มกรอก PIN ผู้ใช้ใหม่อีกครั้ง		LED สีเขียวจะเริ่มติดกะพริบ
8. กดปุ่ม KEY สองครั้ง (ดับเบิลคลิก) 		LED สีแดงที่ติดค้างจะเปลี่ยนเป็น LED สีน้ำเงินติดค้างเพื่อแจ้งว่าเปลี่ยน PIN ผู้ใช้เสร็จสิ้น



**หมายเหตุ:** หากเกิดข้อผิดพลาดระหว่างระบุ PIN ผู้ใช้ใหม่ หรือขั้นตอนไม่เสร็จสมบูรณ์ ไดรฟ์จะค้าง PIN เดิมไว้

## 5. การเปิดใช้งานตัวเลือกต่าง ๆ







โหมด Options ช่วยให้ผู้ใช้สามารถดำเนินการต่าง ๆ เช่น เปิดหรือปิดใช้งาน DT2000 เป็นแบบ อ่านอย่างเดียว กำหนดค่าล๊อคอัตโนมัติ ตามเวลาที่กำหนด และตรวจสอบเวอร์ชันของอุปกรณ์

ตาราง ด้านล่าง แสดง วิธี การ เข้าไปยัง โหมด Options หัวข้อที่ 6 - 9 ระบุ วิธี การ ใช้งาน ฟังก์ชัน ต่าง ๆ

คำแนะนำ	LED	สถานะ LED
1. กดปุ่ม KEY หนึ่งครั้ง 		LED สีแดง เขียว & น้ำเงิน จะติดกะพริบพร้อมกัน หนึ่งครั้ง จากนั้น LED สีแดงจะกะพริบต่อไป
2. ภายใน 10 วินาที ให้กรอก PIN ผู้ใช้ (ค่าเริ่มต้น - 11223344) เพื่อปลดล็อค DT2000		LED สีแดงจะกะพริบต่อไป
3. กดปุ่ม KEY หนึ่งครั้ง 		LED สีแดงที่ติดค้างจะเปลี่ยนเป็น LED สีเขียวติดค้างเพื่อแจ้งว่ากรอก PIN ผู้ใช้เสร็จสิ้น
4. กดปุ่ม KEY 3 ครั้ง (คลิกสามครั้ง) 		LED สีเขียวและสีน้ำเงินจะติดกะพริบพร้อมกันเพื่อรอคำสั่งใหม่ในโหมด OPTIONS

## 6. การเปิดใช้โหมดอ่านอย่างเดียว

DT2000 มีโหมดอ่านอย่างเดียวที่จะจำกัดการเขียนข้อมูลไปยังไดรฟ์ ทำได้ตามขั้นตอนต่อไปนี้

คำแนะนำ	LED	สถานะ LED
1. ปลดล๊อค DT2000 โดยใช้ PIN ผู้ใช้	 → 	LED สีแดงที่ติดค้างจะเปลี่ยนเป็น LED สีเขียวติดค้างเพื่อแจ้งว่ากรอก PIN ผู้ใช้เสร็จสิ้น
2. เปิดใช้ Options โดยกดปุ่ม KEY 3 ครั้ง (คลิกสามครั้ง)   	 & 	LED สีเขียวและสีน้ำเงินจะติดกะพริบพร้อมกันเพื่อรอคำสั่งใหม่ในโหมด OPTIONS
3. ภายใน 10 วินาที ให้เริ่มกดเลข 7 (pqrs) ตามด้วยเลข 6 (mno) (76)	 & 	LED สีเขียวและสีน้ำเงินติดกะพริบพร้อมกันต่อไป
4. กดปุ่ม KEY หนึ่งครั้ง 	 → 	LED สีน้ำเงิน จะจางหายไปอย่างรวดเร็วเปลี่ยนเป็นสีเขียวค้างอยู่ - เมื่อเสียบ DT2000 เข้าที่พอร์ต USB ไฟ LED สีเขียวจะกะพริบทุก ๆ สองวินาทีเพื่อระบุว่าไดรฟ์อยู่ในโหมดอ่านอย่างเดียว













หลังจากเปิดใช้งาน การสืบทันจะจำกัดเป็นแบบอ่านอย่างเดียวจนกว่าจะปิดระบบป้องกันการเขียน



**หมายเหตุ:** เราได้กำหนดรูปแบบการตั้งชื่อเพื่อให้ง่ายสำหรับผู้ใช้ในการจดจำชุดแป้นกดสำหรับค่าเพื่อเลือกแต่ละค่าไว้ จากตารางด้านบน เราได้ใช้ตัวเลขเพื่อใช้แทน อักษรตัวแรก' ของชื่อคุณสมบัติการทำงานเพื่อเลือก เช่น Read-Only = 7 (pqrs) 6 (mno)

## 7. การเปิดใช้โหมดอ่าน/เขียน

สามารถปิดระบบป้องกันการเขียน (อ่านอย่างเดียว) เพื่อให้สามารถอ่าน/เขียนข้อมูลได้ตามปกติ ทำได้ตามขั้นตอนต่อไปนี้

คำแนะนำ	LED	สถานะ LED
1. ปลดล๊อค DT2000 โดยใช้ PIN ผู้ใช้	 → 	LED สีแดงที่ติดค้างจะเปลี่ยนเป็น LED สีเขียวติดค้างเพื่อแจ้งว่ากรอก PIN ผู้ใช้เสร็จสิ้น
2. เปิดใช้ Options โดยกดปุ่ม KEY 3 ครั้ง (คลิกสามครั้ง)   	 & 	LED สีเขียวและสีน้ำเงินจะติดกะพริบพร้อมกันเพื่อรอคำสั่งใหม่ในโหมด OPTIONS
3. ภายใน 10 วินาที ให้กรอกเลข 7 (pqrs) ตามด้วยเลข 9 (wxyz) (79)	 & 	LED สีเขียวและสีน้ำเงินติดกะพริบพร้อมกันต่อไป
4. กดปุ่ม KEY หนึ่งครั้ง 	 → 	LED สีน้ำเงิน จะจางหายไปอย่างรวดเร็วเปลี่ยนเป็นสีเขียวค้างอยู่ - เมื่อเสียบ DT2000 เข้าที่พอร์ต USB ไฟ LED สีเขียวจะกะพริบทุก ๆ สองวินาทีเพื่อระบุว่าไดรฟ์อยู่ในโหมดอ่าน/เขียนข้อมูล







หลังจากเปิดใช้งาน จะสามารถอ่าน/เขียนข้อมูลได้ตามปกติ

## 8. การกำหนดโหมดล็อคเมื่อเกินเวลาที่กำหนด

ปกป้องการสืบค้นโดยไม่ได้รับอนุญาตขณะ DT2000 เชื่อมต่อกับโฮสต์โดยไม่มีคนดูแลโดยตั้งค่า DT2000 ให้ล็อคอัตโนมัติหลังจากผ่านระยะเวลาที่กำหนด







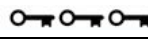

ในสถานะเริ่มต้น ระบบล็อคตามกำหนดเวลาของ DT2000 จะปิดทำงานอยู่ ระบบ Timeout Lock สามารถตั้งค่าให้ทำงาน (ล็อค) ได้ทุกเมื่อระหว่าง 1 - 99 นาที

ตั้งเวลาล็อคเมื่อเกินกำหนดเวลาได้ตามขั้นตอนในตารางต่อไปนี้







คำแนะนำ	LED	สถานะ LED
1. ปลดล็อค DT2000 โดยใช้ PIN ผู้ใช้		LED สีแดงที่ติดค้างจะเปลี่ยนเป็น LED สีเขียวติดค้างเพื่อแจ้งว่ากรอก PIN ผู้ใช้เสร็จสิ้น
2. เปิดใช้ Options โดยกดปุ่ม KEY 3 ครั้ง (คลิกสามครั้ง) 		LED สีเขียวและสีน้ำเงินจะติดกะพริบพร้อมกันเพื่อรอคำสั่งใหม่ในโหมด OPTIONS
3. ภายใน 10 วินาที ให้กรอกเลข 8 (tuv) ตามด้วยเลข 5 (jkl) - (85)		LED สีเขียวและสีน้ำเงินติดกะพริบพร้อมกันต่อไป
4. กดปุ่ม KEY หนึ่งครั้ง 		LED สีเขียวติดกะพริบ
5. ภายใน 10 วินาที ให้กรอกระยะเวลาสำหรับผู้ใช้เป็นเลข 2 หลัก: 00 = 0 นาที (ค่าเริ่มต้น) 01 = 1 นาที 99 = 99 นาที เป็นต้น		LED สีเขียวจะเริ่มติดกะพริบ
6. กดปุ่ม KEY หนึ่งครั้ง 		LED สีเขียวติดค้าง - เปิดใช้ Timeout Lock ไว้

## 9. การปิดโหมดล็อคเมื่อเกินเวลาที่กำหนด

ปิด Timeout Lock ได้ตามขั้นตอนในตารางต่อไปนี้

คำแนะนำ	LED	สถานะ LED
1. ปลดล็อค DT2000 โดยใช้ PIN ผู้ใช้		LED สีแดงที่ติดค้างจะเปลี่ยนเป็น LED สีเขียวติดค้างเพื่อแจ้งว่ากรอก PIN ผู้ใช้เสร็จสิ้น
2. เปิดใช้ Options โดยกดปุ่ม KEY 3 ครั้ง (คลิกสามครั้ง) 		LED สีเขียวและสีน้ำเงินจะติดกะพริบพร้อมกันเพื่อรอคำสั่งใหม่ในโหมด OPTIONS
3. ภายใน 10 วินาที ให้กรอกเลข 8 (tuv) ตามด้วยเลข 5 (jkl) - (85)		LED สีเขียวและสีน้ำเงินติดกะพริบพร้อมกันต่อไป
4. กดปุ่ม KEY หนึ่งครั้ง 		LED สีเขียวติดกะพริบ
5. ภายใน 10 วินาที ให้กรอกตัวเลข 0 สองครั้ง (ดับเบิลคลิก) (ศูนย์ ศูนย์) - (00)		LED สีเขียวจะเริ่มติดกะพริบ
6. กดปุ่ม KEY หนึ่งครั้ง 		LED สีเขียวติดค้าง - ปิดใช้ Timeout Lock อยู่

## 10. การตรวจสอบเลขเวอร์ชันของ DT2000

คำแนะนำ	LED	สถานะ LED
1. ปลดล็อค DT2000 โดยใช้ PIN ผู้ใช้		LED สีแดงที่ติดค้างจะเปลี่ยนเป็น LED สีเขียวติดค้างเพื่อแจ้งว่ารอก PIN ผู้ใช้เสร็จสิ้น
2. เปิดใช้ Options โดยกดปุ่ม KEY 3 ครั้ง (คลิกสามครั้ง) 		LED สีเขียวและสีน้ำเงินจะติดกะพริบพร้อมกันเพื่อรอคำสั่งใหม่ในโหมด OPTIONS
3. ภายใน 10 วินาที ให้กรอกเลข 8 (tuv) ตามด้วยเลข 6 (mno) - (86)		LED สีเขียวและสีน้ำเงินติดกะพริบพร้อมกันต่อไป
4. กดปุ่ม KEY หนึ่งครั้ง 	 	LED สีแดง สีเขียว & สีน้ำเงินจะกะพริบพร้อมกันอย่างรวดเร็วหนึ่งครั้ง ตามด้วย LED สีแดงติดกะพริบสำหรับเลขปรับแก้ตัวแรก จากนั้น LED สีเขียวจะติดกะพริบตามเลขตัวที่สองของเลขการปรับแก้
เช่น หากเลขการปรับแก้คือ '1.8' LED สีแดงจะกะพริบหนึ่ง (1) ครั้ง และ LED สีเขียว จะกะพริบแปด (8) ครั้ง เมื่อลำดับการแสดงผลสถานะสิ้นสุด LED สีแดง สีเขียวและสีน้ำเงินจะกะพริบพร้อมกันหนึ่งครั้ง จากนั้น LED สีเขียวจะติดค้าง		

## 11. ระบบตรวจจับการแฮ็คแบบเจตนา



**ข้อควรระวัง:** หากผู้ใช้กรอก PIN ผู้ใช้ไม่ถูกต้อง 10 (สิบ) ครั้งติดต่อกัน กลไกป้องกันการแฮ็คของ DT2000 จะทำงาน และ PIN ผู้ใช้ คีย์เข้ารหัส รวมทั้งข้อมูลทั้งหมดจะถูกลบทิ้งและสูญหายตลอดไป

PIN ที่ใช้เพื่อปลดล็อค DT2000	จะเกิดอะไรขึ้นหากกรอก PIN ไม่ถูกต้องต่อเนื่องกัน 10 ครั้ง
PIN ผู้ใช้	กลไกป้องกันการแฮ็คโดยเจตนาของ DT2000 จะทำงานและ PIN ผู้ใช้ คีย์เข้ารหัส รวมทั้งข้อมูลทั้งหมดจะถูกลบและสูญหายตลอดไป

หากผู้ใช้กรอก PIN ไม่ถูกต้อง 10 (สิบ) ครั้งติดต่อกัน คีย์เข้ารหัสและข้อมูลทั้งหมดจะถูกลบทิ้งและสูญหายตลอดไป จากนั้น DT2000 จะกลับไปใช้ PIN ผู้ใช้จากโรงงานหรือ 11223344 - ดูวิธีการเปลี่ยน PIN ผู้ใช้ได้จากหัวข้อที่ 4 ในหน้า 6 เนื่องจากกระบวนการนี้กำหนดให้ต้องจัดทำคีย์เข้ารหัสใหม่ DT2000 จึงต้องมีการฟอร์แมตใหม่ (ดูรายละเอียดในหัวข้อที่ 13 หรือ 14)

DT2000 แตกต่างจากอุปกรณ์อื่น ๆ โดยจะมีระบบจัดทำตัวเลขแบบสุ่ม หลังจากรีเซ็ตไดรฟ์แล้ว คีย์เข้ารหัสใหม่จะถูกจัดทำขึ้นแบบสุ่ม

## 12. การรีเซ็ต DT2000

ในกรณีที่ลืม PIN ผู้ใช้ หรือหากผู้ใช้ต้องการลบข้อมูลทั้งหมดใน DT2000 กรุณาทำตามคำแนะนำด้านล่าง

กระบวนการรีเซ็ตเป็นการล้างพารามิเตอร์เข้ารหัสลับทั้งหมด รวมทั้ง PIN ผู้ใช้ ซึ่งหมายถึง DT2000 จะกลับไปใช้ PIN ผู้ใช้เริ่มต้นหรือ 11223344 - วิธีการเปลี่ยน PIN ผู้ใช้ได้จากหัวข้อที่ 4 ในหน้า 6 เนื่องจากกระบวนการนี้กำหนดให้ต้องจัดทำคีย์เข้ารหัสใหม่ DT2000 จึงต้องมีการฟอร์แมตใหม่ (ดูรายละเอียดในหัวข้อที่ 13 หรือ 14)



**ข้อควรระวัง:** การรีเซ็ต DT2000

คำแนะนำ	LED	สถานะ LED
1. กดค้างที่ปุ่มเลข 7 (pqrs) จากนั้นกดปุ่ม KEY  ปลดมือจากปุ่ม (7 &  )		LED สีแดง และสีเขียวกะพริบสลับกัน
2. ภายใน 10 วินาที ให้กรอกหมายเลข 9 (wxyz) สามครั้ง (คลิกสามครั้ง) (999)		LED สีแดง และสีเขียวจะติดกะพริบสลับกันต่อเนื่อง
3. กดค้างที่ปุ่มตัวเลข 7 (pqrs) จากนั้นกดปุ่ม KEY  ปลดมือจากปุ่ม (7 &  )		LED สีแดงจะจางลงเพื่อสิ้นสุดกระบวนการรีเซ็ต

## 13. การกำหนดค่า DT2000 กับ Windows OS

ในกรณีที่ระบบตรวจการแฮ็คทำงานเนื่องจากการกรอก PIN ไม่ถูกต้อง 10 ครั้งติดต่อกัน หรือไดรฟ์ถูกรีเซ็ท **ข้อมูลทั้งหมดในไดรฟ์จะสูญหายตลอดไป.**

หลังจากจัดทำ PIN ผู้ใช้ใหม่ DT2000 จะต้องเริ่มการทำงานและฟอร์แมตใหม่

เริ่มการทำงานของ DT2000 ได้ตามขั้นตอนต่อไปนี้

1. กำหนด PIN ผู้ใช้ใหม่ (ดูในหัวข้อที่ 4)
2. ปลดล็อค DT2000 โดยกรอก PIN ผู้ใช้ใหม่จากนั้นต่อเข้ากับพอร์ต USB ของคอมพิวเตอร์
3. คอมพิวเตอร์ควรแจ้งผู้ใช้ด้วยความต่อไปนี้

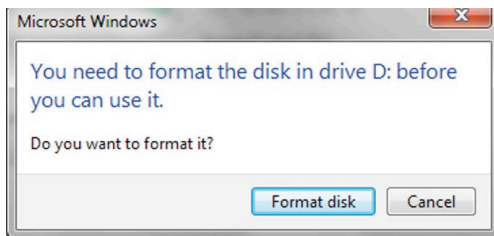

4. ดำเนินการต่อโดยคลิกที่ **Format disk** เลือก **FAT32** หรือ **NTFS** ตามความต้องการของคุณ จากนั้นกรอกชื่อไดรฟ์จากนั้นคลิก **Start**

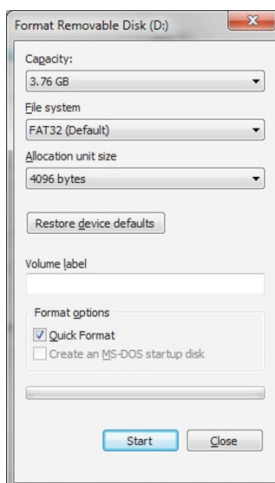

5. คลิก **OK** เพื่อฟอร์แมตไดรฟ์ต่อไป

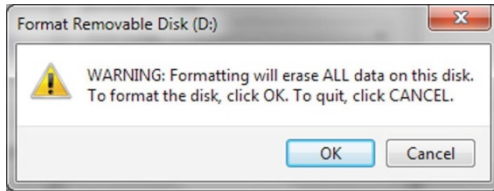

**คำเตือน:** กระบวนการนี้เป็นการลบข้อมูลทั้งหมดที่เก็บอยู่ในไดรฟ์

6. คอมพิวเตอร์จะสิ้นสุดการฟอร์แมตไดรฟ์ และยืนยันว่าฟอร์แมตเสร็จสิ้นแล้ว ขณะที่ DT2000 กำลังฟอร์แมต LED สีน้ำเงินจะติดกะพริบ

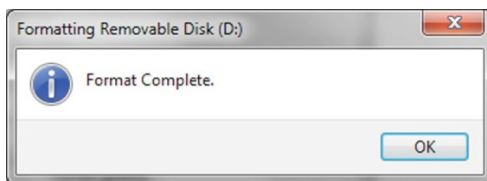

หลังจากเสร็จสิ้น LED สีน้ำเงินจะติดค้างและ DT2000 จะพร้อมสำหรับใช้งาน

หากตัวช่วยฟอร์แมตไม่ปรากฏขึ้น ให้ทำตามขั้นตอนต่อไปนี้

1. คลิกขวาที่ **My Computer** หรือ **Computer** จากนั้นคลิก **Manage**
2. จากหน้าต่าง **Computer Management** ในแท็บ **Disk Management** จะพบ DT2000 เป็นอุปกรณ์ต่อพ่วงฟอร์แมต RAW

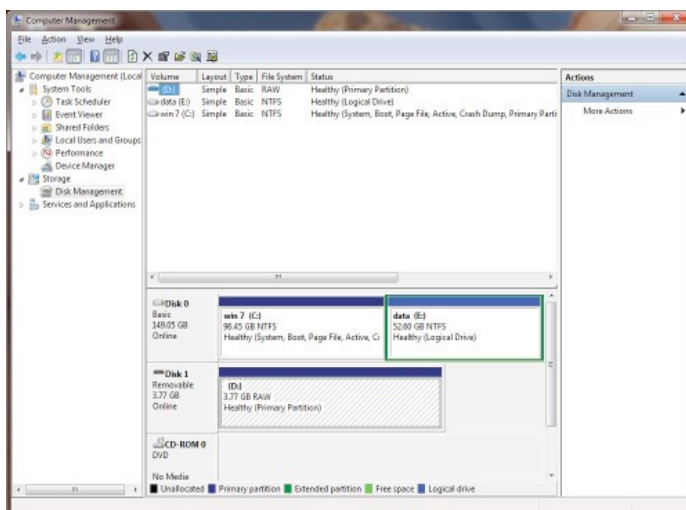



3. จากพื้นที่ว่างด้านล่างส่วนที่ไม่มีการจัดสรร คลิกขวาที่ **Removable Raw Drive** จากนั้นเลือก **Format**

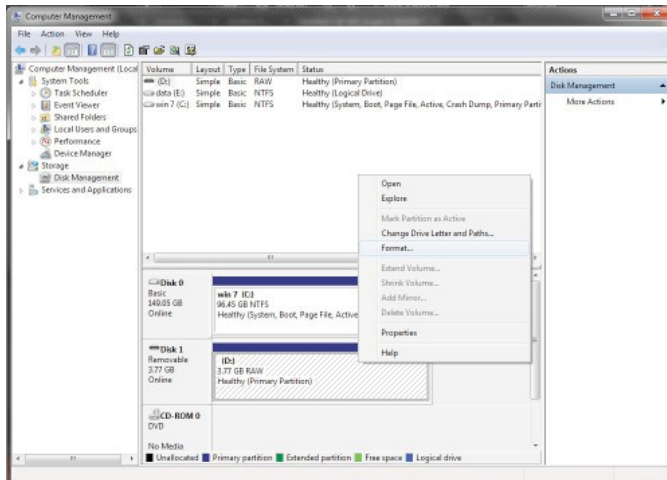

4. หน้าต่าง **Format** จะเปิดขึ้นมา กรอกชื่อไดรฟ์ใหม่ เลือก **FAT32** หรือ **NTFS** ตามความต้องการของคุณ จากนั้นคลิก **OK**

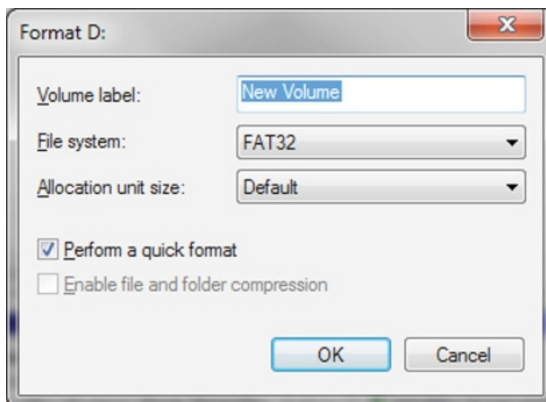

5. คลิก **OK** จากหน้าต่างแจ้งเตือน **Format** เพื่อฟอร์แมตไดรฟ์ต่อไป

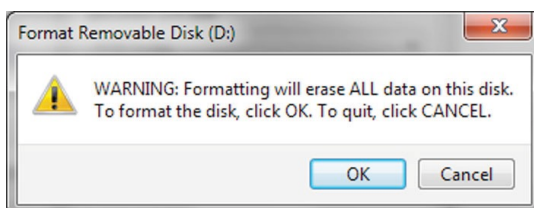

**คำเตือน:** กระบวนการนี้เป็นการลบข้อมูลทั้งหมดที่เก็บอยู่ในไดรฟ์

## 6. คอมพิวเตอร์จะสิ้นสุดการฟอร์แมตและกลับไปหน้าจอต่าง Disk Management

ขณะ DT2000 ทำการฟอร์แมต LED สีน้ำเงินจะเริ่มติดกะพริบ

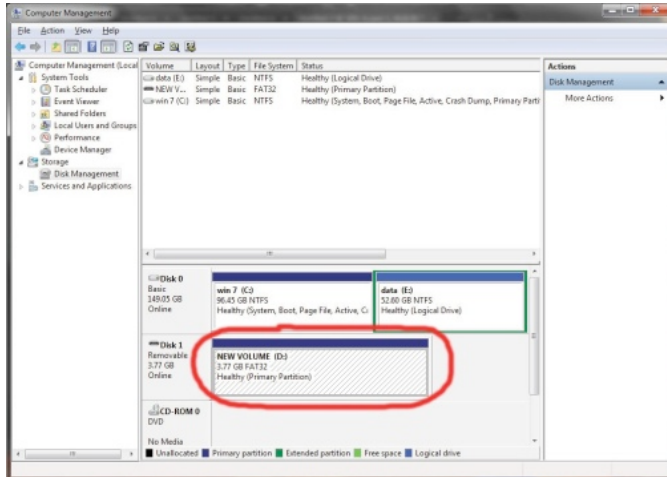

หลังจากเสร็จสิ้น LED สีน้ำเงินจะติดค้างและ DT2000 จะพร้อมสำหรับใช้งาน

## 14. การกำหนดค่า DT2000 กับ Mac OS

ในกรณีที่ระบบตรวจการแฮ็คทำงานเนื่องจากการกรอก PIN ไม่ถูกต้อง 10 ครั้งติดต่อกัน หรือไดรฟ์ถูกรีเซ็ท **ข้อมูลทั้งหมดในไดรฟ์จะสูญหายตลอดไป**

หลังจากจัดทำ PIN ผู้ใช้ใหม่ DT2000 จะต้องเริ่มการทำงานและฟอร์แมตใหม่

ฟอร์แมต DT2000 ในคอมพิวเตอร์ Mac OS ได้ตามขั้นตอนต่อไปนี้

1. กำหนด PIN ผู้ใช้ใหม่ (ดูในหัวข้อที่ 4)
2. ปลดล็อก DT2000 โดยกรอก PIN ผู้ใช้ใหม่จากนั้นต่อเข้ากับพอร์ต USB ของคอมพิวเตอร์ Mac ระบบจะแจ้งหน้าต่าง INITIALIZE ขึ้นมา

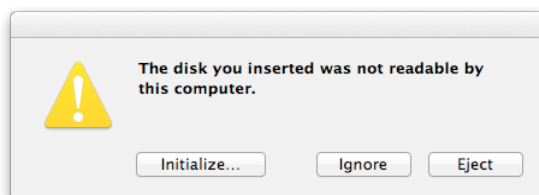

### 3. กด INITIALIZE จากนั้นเลือก DT2000 ในหน้าต่าง Disk Utility

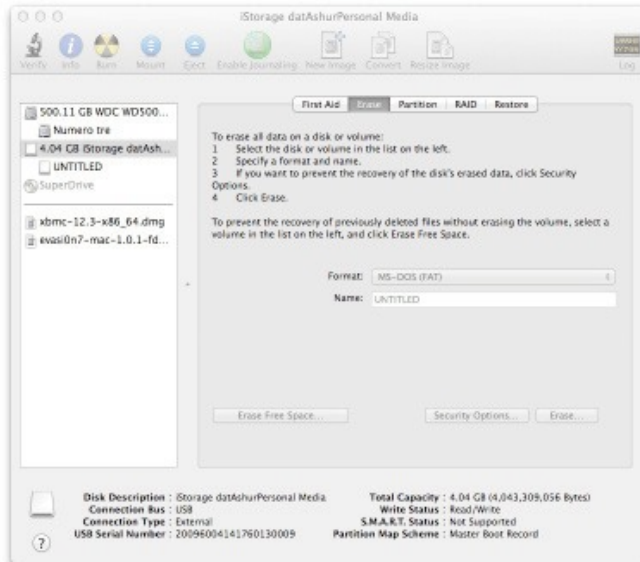

4. คลิกที่ DT2000 จากด้านซ้ายของหน้าต่าง Disk Utility
5. เลือก Erase จากเมนูเนื้อหาทางด้านขวาของหน้าต่าง เลือก MS-DOS สำหรับ Volume Format
6. คลิก Erase

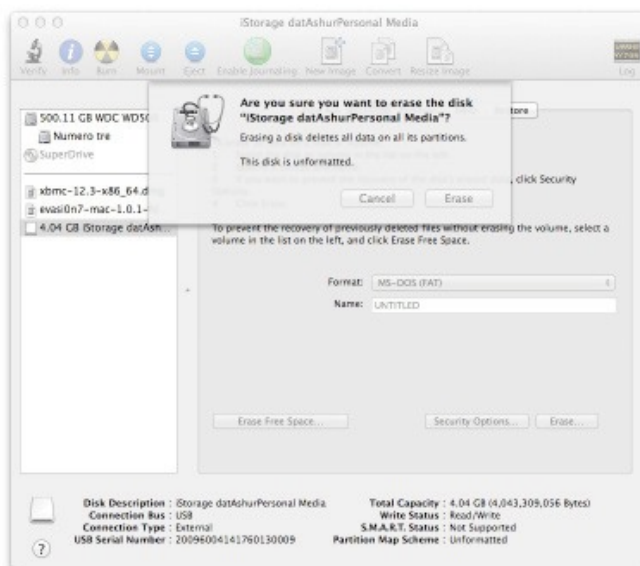

## 7. DT2000 ที่ฟอร์แมตแล้วจะปรากฏขึ้นในหน้าต่าง Disk Utility และเชื่อมต่อไปยังเดสก์ทอป

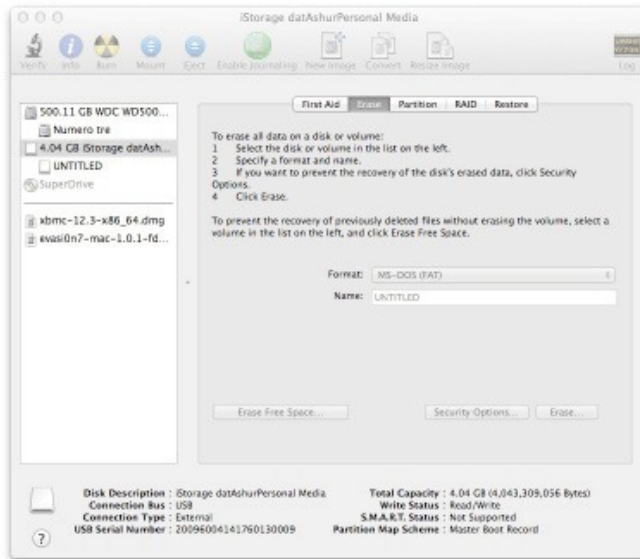

### ข้อมูลแบดเดอรี / การทิ้งผลิตภัณฑ์

อย่าทิ้งอุปกรณ์ไฟฟ้าหรืออุปกรณ์ที่มีแบตเตอรี่กับขยะทั่วไปในครัวเรือน ซึ่งอุปกรณ์อิเล็กทรอนิกส์โดยดียวถึงผลกระทบต่อสิ่งแวดล้อมด้านสิ่งแวดล้อมเป็นสำคัญ อย่าขายตามบ้านหรือเครื่องสำอางค์หรือเครื่องสำอางค์ โดย Kingston หรือผู้ขายท่านอื่น **สอบถาม** เพิ่มเติมเกี่ยวกับแบดเดอรีและการรีไซเคิลผลิตภัณฑ์ได้จากเรา

DataTraveler® 2000 เลือกใช้เทคโนโลยี DataLock® จาก ClevX, LLC.

## DataTraveler® 2000 - Hướng dẫn sử dụng



**Hãy nhớ lưu mã PIN của bạn ở một nơi an toàn. Nếu bạn mất hoặc quên mã PIN, sẽ không có cách nào để truy cập dữ liệu lưu trữ trên Kingston DataTraveler®.**

**Nếu bạn gặp khó khăn, vui lòng tham khảo hướng dẫn sử dụng đầy đủ này trên thiết bị DT2000 của bạn và trang web của Kingston: [kingston.com/support](http://kingston.com/support)**

DataTraveler® 2000 tích hợp công nghệ DataLock® Technology do ClevX, LLC cấp phép.

©2016 Kingston Technology Far East Co. Ltd (Asia Headquarters) No. 1-5, Li-Hsin Rd. 1, Science Park, Hsin Chu, Taiwan, R.O.C. Mọi quyền được bảo lưu. Các nhãn hiệu thương mại được đăng ký và các nhãn hiệu thương mại là tài sản của các chủ sở hữu tương ứng.

## Mục lục

Yêu cầu hệ thống .....	3
Giới thiệu .....	4
1. Bố cục DT2000.....	5
2. Đèn LED chỉ thị và ý nghĩa.....	5
3. Cách sử dụng DT2000 lần đầu tiên .....	6
4. Cách đổi mã PIN người dùng.....	6
5. Cách bật các Tùy chọn.....	7
6. Cách bật Chế độ chỉ đọc.....	8
7. Cách bật Chế độ đọc/ghi.....	8
8. Cách đặt chế độ Khóa khi hết giờ .....	9
9. Cách tắt chế độ Khóa khi hết giờ .....	9
10. Cách xác định số phiên bản của DT2000 .....	10
11. Phát hiện tấn công Brute Force.....	10
12. Cách đặt lại DT2000.....	11
13. Cách cấu hình DT2000 với hệ điều hành Windows .....	12
14. Cách cấu hình DT2000 với hệ điều hành Mac.....	15



## ***Giới thiệu về Hướng dẫn sử dụng này***

Hướng dẫn sử dụng này dành cho thiết bị DataTraveler® 2000 của Kingston (từ đây gọi tắt là DT2000).

### **Yêu cầu hệ thống**

---

#### **Nền tảng PC**

#### **Hỗ trợ hệ điều hành PC**

- Windows 10
  - Windows 8/8.1
  - Windows 7
  - Windows Vista® SP2
- 

#### **Nền tảng Mac**

#### **Hỗ trợ hệ điều hành**

- Mac OS X 10.8.x - 10.11x
- 

#### **Nền tảng Linux**

#### **Hỗ trợ hệ điều hành**

- Nhân Linux v2.6+
- 

#### **Các nền tảng khác Hỗ trợ hệ điều hành**

#### **Hỗ trợ hệ điều hành**

- Chrome OS™, Android\*
- 

\*Chỉ áp dụng với các thiết bị tương thích. Kiểm tra với nhà sản xuất thiết bị để xem thiết bị có hỗ trợ USB Flash không.

## Giới thiệu



**Lưu ý:** Pin sạc của DT2000 không được sạc đầy khi mới mở hộp. Chúng tôi khuyên bạn hãy sạc pin trước lần sử dụng đầu tiên. Để sạc, cắm DT2000 vào một cổng USB có điện trong 60 phút để sạc đầy pin.

Cảm ơn bạn đã mua DataTraveler® 2000, USB 3.0 siêu bảo mật và dễ sử dụng đã được kích hoạt mã PIN và mã hóa phần cứng.



DT2000 sử dụng công nghệ mã hóa phần cứng XTS-AES 256 bit cấp quân đội, công nghệ này mã hóa mọi dữ liệu lưu trữ trên USB theo thời gian thực. DT2000 không yêu cầu phần mềm và không phụ thuộc vào hệ điều hành và thiết bị chủ.

DT2000 tích hợp một pin sạc cho phép người dùng nhập một mã PIN (Số định danh cá nhân) gồm 7-15 chữ số trên bàn phím tích hợp sẵn trước khi kết nối thiết bị với cổng USB.

Nếu USB bị thất lạc hoặc mất cắp, người dùng có thể yên tâm rằng tất cả dữ liệu lưu trữ trên DT2000 vẫn an toàn và không bị truy cập trái phép.

DT2000 mở khóa thông qua bàn phím tích hợp sẵn, không phải qua máy tính chủ. USB không bị gây hại trước các trình theo dõi thao tác bàn phím (keylogger) dựa trên phần mềm/phần cứng hoặc các cuộc tấn công brute force.



**Thận trọng:** Khi xuất xưởng, DT2000 có mã PIN người  1-1-2-2-3-3-4-4   
và mặc dù bạn có thể sử dụng ngay mã PIN mặc định này, vì lý do an ninh, chúng tôi **khuyến bạn nên tạo một mã PIN người dùng mới ngay lập tức** bằng cách làm theo các hướng dẫn trong phần 4 'Cách đổi mã PIN người dùng'.







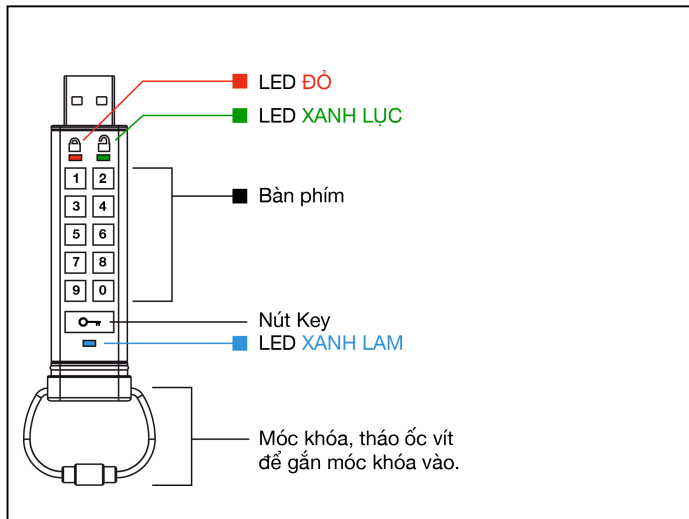











Nếu quên mã PIN, bạn sẽ không thể truy cập dữ liệu của mình.



## 1. Bộ cục DT2000







## 2. Đèn LED chỉ thị và ý nghĩa

LED	Trạng thái LED	Mô tả	Trạng thái LED	Mô tả	Mô tả
	<b>Đỏ Đen</b> tắt dần 	Đang khóa lại/nhập sai mã PIN	 / 	<b>Đỏ và Xanh lục</b> luân phiên nhấp nháy 	Đặt lại mặc định
	<b>Đỏ</b> nhấp nháy 	Đã khóa và đang chờ nhập mã PIN mặc định hoặc mã PIN đã tạo			
	<b>Xanh lục</b> sáng liên tục 	DT2000 được mở khóa	 & 	<b>Xanh lục và Xanh lam</b> nhấp nháy cùng lúc 	Chế độ tùy chọn người dùng
	<b>Xanh lục</b> nhấp nháy 	Khi kết nối với cổng USB nếu đèn LED <b>Xanh lục</b> nhấp nháy sau mỗi 2 giây, điều này cho biết DT2000 đã được thiết lập ở chế độ 'Chỉ đọc'			
	<b>Xanh lam</b> sáng liên tục 	Đã kết nối với cổng USB			
	<b>Xanh lam</b> nhấp nháy 	Trao đổi dữ liệu với thiết bị chủ/đang thay đổi mã PIN người dùng			



### 3. Cách sử dụng DT2000 lần đầu tiên

Khi xuất xưởng DT2000 có mã PIN mặc định là 11223344 và mặc dù bạn có thể sử dụng ngay mã PIN mặc định này, vì lý do an ninh, chúng tôi khuyên bạn nên tạo một mã PIN người dùng mới ngay lập tức bằng cách làm theo các hướng dẫn trong phần 4 ‘Cách đổi mã PIN người dùng’.

Vui lòng làm theo 3 bước đơn giản trong bảng dưới đây để mở khóa DT2000 với mã PIN mặc định.

Hướng dẫn (sử dụng lần đầu tiên)	LED	Trạng thái LED
1. Ấn nút KEY một lần 		<b>Đèn LED Đỏ, Xanh lục &amp; Xanh lam</b> sẽ sáng lên cùng một lúc và sau đó đèn LED <b>Đỏ</b> sẽ tiếp tục nhấp nháy
2. Trong vòng 10 giây hãy nhập mã PIN người dùng (mặc định là 11223344) để mở khóa DT2000		<b>Đèn LED Đỏ</b> sẽ tiếp tục nhấp nháy
3. Ấn nút KEY một lần 		<b>Đèn LED Đỏ</b> sáng liên tục chuyển thành đèn LED <b>Xanh lục</b> sáng liên tục cho biết đã nhập mã PIN người dùng mặc định thành công



**Lưu ý:** Một khi DT2000 đã được mở khóa thành công, đèn LED **Xanh lục** sẽ vẫn bật và ở trạng thái sáng liên tục chỉ trong 30 giây, trong thời gian đó cần kết nối DT2000 với cổng USB. Có thể khóa thiết bị ngay lập tức bằng cách ấn và giữ nút KEY  trong 3 giây hoặc chờ hết 30 giây hoặc nhấn vào biểu tượng  ‘Safely Remove Hardware and Eject Media’ trên hệ điều hành.

### 4. Cách đổi mã PIN người dùng

Yêu cầu về PIN:













- Phải có độ dài trong khoảng 7-15 chữ số
- Không được chứa chỉ toàn các con số lặp lại, ví dụ (3-3-3-3-3-3)
- Không được chứa chỉ toàn các con số liên tiếp, ví dụ (1-2-3-4-5-6-7), (7-8-9-0-1-2-3-4), (7-6-5-4-3-2-1)

**Mẹo đặt mật khẩu:** Bạn có thể tạo ra một từ, tên, cụm từ dễ nhớ hoặc bất kỳ mã PIN nào khác kết hợp cả số và chữ bằng cách ấn phím với các chữ cái tương ứng trên đó.

Đây là ví dụ về các kiểu mã PIN kết hợp cả số và chữ:

- Đối với “**password**” bạn sẽ ấn các phím sau:  
7 (pqr) 2 (abc) 7 (pqr) 7 (pqr) 9 (wxyz) 6 (mno) 7 (pqr) 3 (def)
- Đối với “**kingston**” bạn sẽ ấn:  
5 (jkl) 4 (ghi) 6 (mno) 4 (ghi) 7 (pqr) 8 (tuv) 6 (mno) 6 (mno)

Với phương pháp này, bạn có thể tạo ra các mã PIN dài và dễ nhớ.

Hướng dẫn	LED	Trạng thái LED
1. Ấn nút KEY một lần 		<b>Đèn LED Đỏ, Xanh lục &amp; Xanh lam</b> sẽ sáng lên cùng một lúc và sau đó đèn LED <b>Đỏ</b> sẽ tiếp tục nhấp nháy
2. Trong vòng 10 giây hãy bắt đầu nhập mã PIN người dùng (mặc định là 11223344) để mở khóa DT2000		<b>Đèn LED Đỏ</b> sẽ tiếp tục nhấp nháy
3. Ấn nút KEY một lần 		<b>Đèn LED Đỏ</b> sáng liên tục chuyển thành đèn LED <b>Xanh lục</b> sáng liên tục cho biết đã nhập mã PIN người dùng mặc định thành công
4. Ấn nút KEY hai lần (nhấp đúp) 		<b>Đèn LED Xanh lam</b> nhấp nháy
5. Trong vòng 10 giây hãy bắt đầu nhập Mã PIN người dùng mới		<b>Đèn LED Xanh lam</b> tiếp tục nháy
6. Ấn nút KEY hai lần (nhấp đúp) 		<b>Đèn LED Xanh lục</b> nhấp nháy
7. Trong vòng 10 giây hãy bắt đầu nhập lại Mã PIN người dùng mới		<b>Đèn LED Xanh lục</b> tiếp tục nhấp nháy
8. Ấn nút KEY hai lần (nhấp đúp) 		<b>Đèn LED Đỏ</b> sáng liên tục chuyển thành đèn LED <b>Xanh lục</b> sáng liên tục cho biết đã thay đổi mã PIN người dùng thành công









**Lưu ý:** Nếu xảy ra lỗi khi tạo mã PIN người dùng mới hoặc quá trình không hoàn tất, thiết bị sẽ vẫn giữ mã PIN cũ.

## 5. Cách bật các Tùy chọn







Chế độ Tùy chọn sẽ cho phép người dùng thực hiện các chức năng khác nhau như bật hoặc tắt chế độ 'Chỉ đọc' của DT2000, thiết lập chế độ tự động khóa khi 'Hết giờ' và xác định phiên bản của thiết bị.

Bảng dưới đây minh họa cách truy cập chế độ Tùy chọn, các phần 6 - 9 mô tả cách thực hiện các chức năng khác nhau.

Hướng dẫn	LED	Trạng thái LED
1. Ấn nút KEY một lần 		<b>Đèn LED Đỏ, Xanh lục &amp; Xanh lam</b> sẽ sáng cùng một lúc và sau đó đèn LED <b>Đỏ</b> sẽ tiếp tục nhấp nháy
2. Trong vòng 10 giây hãy nhập mã PIN người dùng (mặc định là 11223344) để mở khóa DT2000		<b>Đèn LED Đỏ</b> sẽ tiếp tục nhấp nháy
3. Ấn nút KEY một lần 		<b>Đèn LED Đỏ</b> sáng liên tục chuyển thành đèn LED <b>Xanh lục</b> sáng liên tục cho biết đã nhập mã PIN người dùng thành công
4. Ấn nút KEY 3 lần (nhấp ba lần) 		<b>Đèn LED Xanh lục và Xanh lam</b> nhấp nháy cùng lúc để chờ chỉ dẫn mới trong chế độ TÙY CHỌN

## 6. Cách bật Chế độ chỉ đọc

DT2000 có chế độ chỉ đọc để hạn chế quyền ghi vào thiết bị. Bật chế độ này bằng cách thực hiện các bước sau.

Hướng dẫn	LED	Trạng thái LED
1. Mở khóa DT2000 với mã PIN người dùng		<b>Đèn LED Đỏ</b> sáng liên tục chuyển thành đèn LED <b>Xanh lục</b> sáng liên tục cho biết đã nhập mã PIN người dùng thành công
2. Bật chế độ Tùy chọn bằng cách ấn nút KEY 3 lần (nhấp ba lần) 		<b>Đèn LED Xanh lục</b> và <b>Xanh lam</b> nhấp nháy cùng lúc để chờ chỉ dẫn mới trong chế độ TÙY CHỌN.
3. Trong vòng 10 giây bắt đầu ấn nút số 7 (pqrs) sau đó là nút số 6 (mno) (76)		<b>Đèn LED Xanh lục</b> và <b>Xanh lam</b> tiếp tục nhấp nháy cùng lúc
4. Ấn nút KEY một lần 		<b>Đèn LED Xanh lam</b> nhanh chóng tắt dần và chuyển sang <b>Xanh lục</b> sáng liên tục - khi DT2000 được cắm vào cổng USB đèn LED <b>Xanh lục</b> nhấp nháy sau mỗi hai giây cho biết thiết bị đang ở chế độ chỉ đọc





Khi đã bật, bạn chỉ có thể đọc cho đến khi chế độ hạn chế ghi được tắt đi.

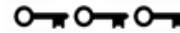

**Lưu ý:** Chúng tôi đã áp dụng một quy tắc đặt tên để giúp người dùng dễ nhớ quy trình ấn phím cho mỗi thiết lập tùy chọn. Trong bảng trên chúng tôi đã sử dụng các con số để thể hiện những chữ cái đầu tiên của tên tính năng tùy chọn. Ví dụ, **Read-Only** (Chỉ đọc) = 7 (pqrs) 6 (mno).

## 7. Cách bật Chế độ đọc/ghi

Truy cập ở chế độ hạn chế ghi (Chỉ đọc) có thể được tắt đi để khôi phục quyền Đọc/Ghi. Bật chế độ này bằng cách thực hiện các bước sau.

Hướng dẫn	LED	Trạng thái LED
1. Mở khóa DT2000 với mã PIN người dùng		<b>Đèn LED Đỏ</b> sáng liên tục chuyển thành đèn LED <b>Xanh lục</b> sáng liên tục cho biết đã nhập mã PIN người dùng thành công
2. Bật chế độ Tùy chọn bằng cách ấn nút KEY 3 lần (nhấp ba lần) 		<b>Đèn LED Xanh lục</b> và <b>Xanh lam</b> nhấp nháy cùng lúc để chờ chỉ dẫn mới trong chế độ TÙY CHỌN
3. Trong vòng 10 giây hãy ấn nút số 7 (pqrs) sau đó là nút số 9 (wxyz) (79)		<b>Đèn LED Xanh lục</b> và <b>Xanh lam</b> tiếp tục nhấp nháy cùng lúc
4. Ấn nút KEY một lần 		<b>Đèn LED Xanh lam</b> nhanh chóng tắt dần và chuyển sang <b>Xanh lục</b> sáng liên tục - khi DT2000 được cắm vào cổng USB đèn LED <b>Xanh lục</b> nhấp nháy sau mỗi hai giây cho biết thiết bị đang ở chế độ Đọc/Ghi









Khi đã bật, quyền truy cập được khôi phục về trạng thái Đọc/Ghi mặc định.

## 8. Cách đặt chế độ Khóa khi hết giờ

Để ngăn chặn truy cập trái phép khi DT2000 được kết nối với máy chủ và không sử dụng, bạn có thể thiết lập để DT2000 tự động khóa sau một khoảng thời gian định sẵn.









Theo mặc định, tính năng Khóa khi hết giờ của DT2000 được tắt đi. Tính năng khóa khi hết giờ có thể được thiết lập để kích hoạt (khóa) sau khoảng thời gian bất kỳ từ 1 đến 99 phút.

Để thiết lập Khóa khi hết giờ, hãy làm theo các bước trong bảng dưới đây.







Hướng dẫn	LED	Trạng thái LED
1. Mở khóa DT2000 với mã PIN người dùng		<b>Đèn LED Đỏ</b> sáng liên tục chuyển thành đèn LED <b>Xanh lục</b> sáng liên tục cho biết đã nhập mã PIN người dùng thành công
2. Bật chế độ Tùy chọn bằng cách ấn nút KEY 3 lần (nhấp ba lần) 		<b>Đèn LED Xanh lục</b> và <b>Xanh lam</b> nhấp nháy cùng lúc để chờ chỉ dẫn mới trong chế độ TÙY CHỌN
3. Trong vòng 10 giây hãy ấn nút số <b>8</b> (tuv) sau đó là nút số <b>5</b> (jkl) - ( <b>85</b> )		<b>Đèn LED Xanh lục</b> và <b>Xanh lam</b> tiếp tục nhấp nháy cùng lúc
4. Ấn nút KEY một lần 		Đèn LED <b>Xanh lục</b> nhấp nháy
5. Trong vòng 10 giây hãy nhập độ dài của thời gian hết giờ bằng 2 chữ số: 00 = 0 phút (Mặc định) 01 = 1 phút 99 = 99 phút, vv..		<b>Đèn LED Xanh lục</b> tiếp tục nhấp nháy
6. Nhấn nút KEY một lần 		<b>Đèn LED Xanh lục</b> sáng liên tục - Đã bật chế độ Khóa khi hết giờ

## 9. Cách tắt chế độ Khóa khi hết giờ

Để tắt chế độ Khóa khi hết giờ, hãy làm theo các bước trong bảng dưới đây.

Hướng dẫn	LED	Trạng thái LED
1. Mở khóa DT2000 với mã PIN người dùng		<b>Đèn LED Đỏ</b> sáng liên tục chuyển thành đèn LED <b>Xanh lục</b> sáng liên tục cho biết đã nhập mã PIN người dùng thành công
2. Bật chế độ Tùy chọn bằng cách ấn nút KEY 3 lần (nhấp ba lần) 		<b>Đèn LED Xanh lục</b> và <b>Xanh lam</b> nhấp nháy cùng lúc để chờ chỉ dẫn mới trong chế độ TÙY CHỌN
3. Trong vòng 10 giây hãy ấn nút số <b>8</b> (tuv) sau đó là nút số <b>5</b> (jkl) - ( <b>85</b> )		<b>Đèn LED Xanh lục</b> và <b>Xanh lam</b> tiếp tục nhấp nháy cùng lúc
4. Ấn nút KEY một lần 		Đèn LED <b>Xanh lục</b> nhấp nháy
5. Trong vòng 10 giây hãy ấn nút số <b>0</b> hai lần (nhấp đúp) ( <b>zero zero</b> ) - ( <b>00</b> )		<b>Đèn LED Xanh lục</b> tiếp tục nhấp nháy
6. Nhấn nút KEY một lần 		<b>Đèn LED Xanh lục</b> sáng liên tục - Đã tắt chế độ Khóa khi hết giờ

## 10. Cách xác định số phiên bản của DT2000

Hướng dẫn	LED	Trạng thái LED
1. Mở khóa DT2000 với mã PIN người dùng		<b>Đèn LED Đỏ</b> sáng liên tục chuyển thành đèn LED <b>Xanh lục</b> sáng liên tục cho biết đã nhập mã PIN người dùng thành công
2. Bật chế độ Tùy chọn bằng cách ấn nút KEY 3 lần (nhấp ba lần) 		<b>Đèn LED Xanh lục</b> và <b>Xanh lam</b> nhấp nháy cùng lúc để chờ chỉ dẫn mới trong chế độ TÙY CHỌN
3. Trong vòng 10 giây hãy ấn nút số 8 (tu <b>v</b> ) sau đó là nút số 6 (m <b>no</b> ) ( <b>86</b> )		<b>Đèn LED Xanh lục</b> và <b>Xanh lam</b> tiếp tục nhấp nháy cùng lúc
4. Ấn nút KEY một lần 	 	<b>Đèn LED Đỏ, Xanh lục &amp; Xanh lam</b> sẽ nhấp nháy cùng nhau một lần rất nhanh trước khi đèn LED <b>Đỏ</b> nhấp nháy theo chữ số có nghĩa đầu tiên của số phiên bản, sau đó đèn LED <b>Xanh lục</b> sẽ nhấp nháy theo chữ số có nghĩa thứ hai của số phiên bản

Ví dụ nếu số phiên bản là '1.8'. đèn LED **Đỏ** sẽ nhấp nháy một (1) lần và đèn LED **Xanh lục** sẽ nhấp nháy tám (8) lần. Khi kết thúc dãy số đèn LED **Đỏ, Xanh lục** và **Xanh lam** sẽ nhấp nháy cùng nhau một lần và sau đó đèn **Xanh lục** sẽ sáng liên tục.

## 11. Phát hiện tấn công Brute Force



**Thận trọng:** Nếu một người dùng nhập sai mã PIN 10 (mười) lần liên tiếp, cơ chế chống brute force của DT2000 sẽ kích hoạt và mã PIN người dùng, khóa mã hóa, **cùng với tất cả dữ liệu**, sẽ bị xóa và mất vĩnh viễn.

Mã PIN được sử dụng để mở khóa DT2000	Điều gì xảy ra sau 10 lần nhập sai mã PIN liên tiếp?
Mã PIN người dùng	Cơ chế chống brute force của DT2000 sẽ kích hoạt và mã PIN người dùng, khóa mã hóa và tất cả dữ liệu sẽ bị xóa và mất vĩnh viễn.

Nếu người dùng nhập sai mã PIN 10 lần liên tiếp, khóa mã hóa và tất cả dữ liệu sẽ bị xóa và mất vĩnh viễn. DT2000 sau đó sẽ đặt lại mã PIN người dùng mặc định là 11223344 - xem phần 4 trên trang 6 về cách đổi mã PIN người dùng. Tương tự, vì quá trình này sẽ yêu cầu tạo một khóa mã hóa mới, DT2000 sẽ phải được định dạng lại (xem phần 13 hoặc 14).

Không giống với các USB tương tự, DT2000 tích hợp một bộ tạo số ngẫu nhiên. Khi USB được đặt lại, một khóa mã hóa mới sẽ được tạo ra một cách ngẫu nhiên.







## 12. Cách đặt lại DT2000

Trong trường hợp bạn quên mã PIN người dùng hoặc muốn xóa tất cả dữ liệu lưu trữ trên DT2000, vui lòng làm theo hướng dẫn dưới đây.

Quá trình đặt lại sẽ xóa tất cả các tham số mã hóa, bao gồm cả mã PIN người dùng. Điều này có nghĩa là DT2000 sẽ đặt lại mã PIN người dùng mặc định là 11223344 - xem phần 4 trên trang 6 về cách đổi mã PIN người dùng. Tương tự, vì quá trình này sẽ yêu cầu tạo một khóa mã hóa mới, DT2000 sẽ phải được định dạng lại (xem phần 13 hoặc 14).



**Thận trọng:** Đặt lại DT2000 sẽ xóa **tất cả dữ liệu** lưu trữ trên USB.

Hướng dẫn	LED	Trạng thái LED
1. Ấn và giữ nút số <b>7</b> (pqrs) và sau đó ấn nút KEY  . Nhả các nút ( <b>7 &amp; </b> )		<b>Đèn LED Đỏ</b> và <b>Xanh lục</b> luân phiên nhấp nháy
2. Trong vòng 10 giây hãy ấn nút số <b>9</b> (wxyz) ba lần (nhấp ba lần) ( <b>999</b> )		<b>Đèn LED Đỏ</b> và <b>Xanh lục</b> tiếp tục luân phiên nhấp nháy
3. Ấn và giữ nút số <b>7</b> (pqrs) và sau đó ấn nút KEY  . Nhả các nút ( <b>7 &amp; </b> )		<b>Đèn LED Đỏ</b> tắt dần để hoàn tất quá trình đặt lại

## 13. Cách cấu hình DT2000 với hệ điều hành Windows

Trong trường hợp cơ chế phát hiện tấn công đã được kích hoạt sau **10 lần nhập sai mã PIN** liên tiếp hoặc USB đã được **đặt lại**, **tất cả dữ liệu trên thiết bị sẽ bị mất vĩnh viễn**.

Khi một **mã PIN người dùng** mới đã được tạo, DT2000 sẽ cần được khởi tạo và định dạng.

**Để khởi tạo thiết bị DT2000, hãy làm theo các bước sau:**

1. Tạo một **mã PIN người dùng** mới (xem phần 4).
2. Mở khóa DT2000 bằng cách nhập **mã PIN người dùng** mới và kết nối với cổng USB của máy tính.
3. Máy tính sẽ đưa ra thông báo sau đây cho người dùng:

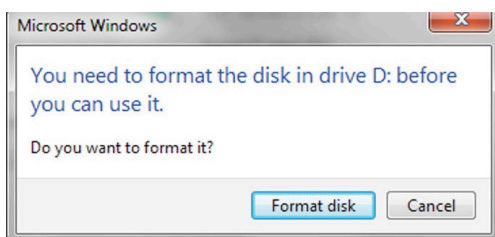

4. Tiếp tục bằng cách nhấp vào **Format disk**. Chọn **FAT32** hoặc **NTFS** tùy theo nhu cầu của bạn, nhập một **Volume Label** và nhấp **Start**.

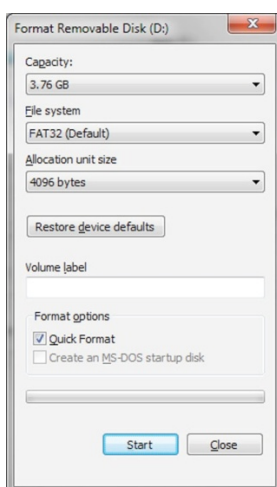



5. Nhấp **OK** để tiếp tục định dạng thiết bị.

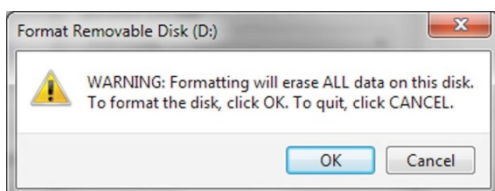

**Cảnh báo:** Quá trình này sẽ xóa **tất cả dữ liệu** lưu trữ trên USB.

6. Máy tính sẽ hoàn tất việc định dạng USB và xác nhận rằng việc định dạng đã hoàn thành. Khi định dạng DT2000 đèn LED **Xanh lam** sẽ nhấp nháy.

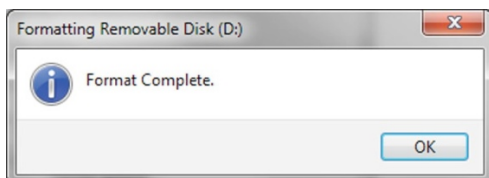

Khi hoàn thành, đèn LED **Xanh lam** sẽ sáng liên tục và DT2000 đã sẵn sàng sử dụng.

**Nếu trình hướng dẫn định dạng không xuất hiện, vui lòng làm theo quy trình dưới đây:**

1. Nhấp chuột phải vào **My Computer** hoặc **Computer** và sau đó nhấp **Manage**.
2. Trong cửa sổ **Computer Management** dưới thẻ **Disk Management**, DT2000 được phát hiện là một thiết bị tháo rời ở định dạng gốc.

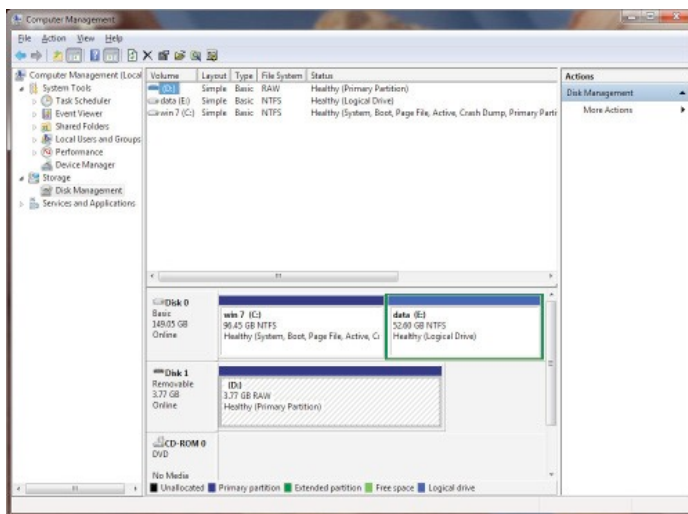

- Trong vùng trống dưới phần Unallocated, nhấp chuột phải vào **Removable Raw Drive** và chọn **Format**.

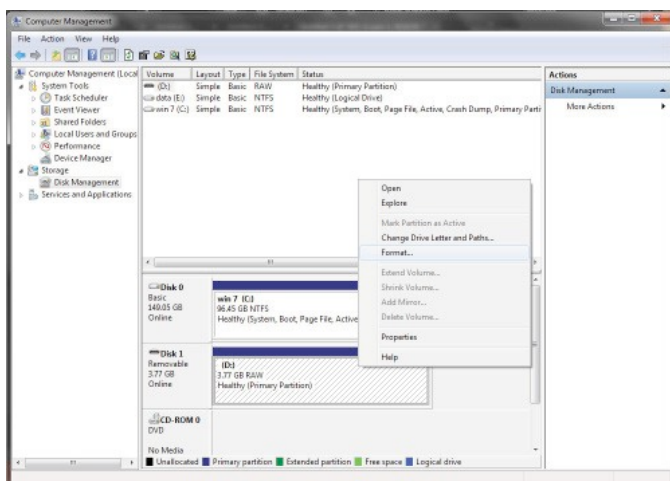

- Cửa sổ **Format** sẽ mở ra.  
Nhập một **Volume Label** mới.  
Chọn **FAT32** hoặc **NTFS** tùy thuộc vào nhu cầu của bạn và nhấp **OK**.

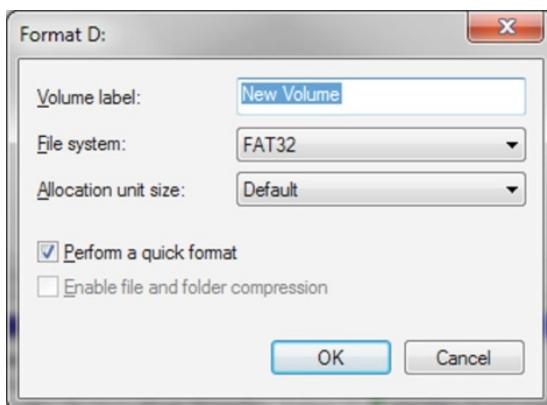

- Nhấp **OK** trên cửa sổ cảnh báo **Format** để tiếp tục định dạng thiết bị.

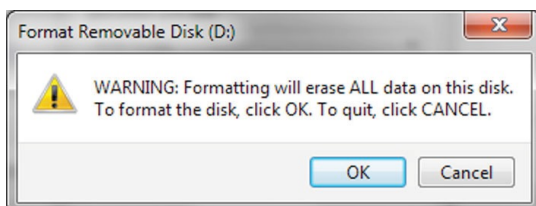

**Cảnh báo:** Quá trình này sẽ xóa **tất cả dữ liệu** lưu trữ trên USB.

6. Máy tính sẽ hoàn thành việc định dạng và trở lại cửa sổ **Disk Management**.

Khi định dạng DT2000 đèn LED **Xanh lam** sẽ bắt đầu nhấp nháy.

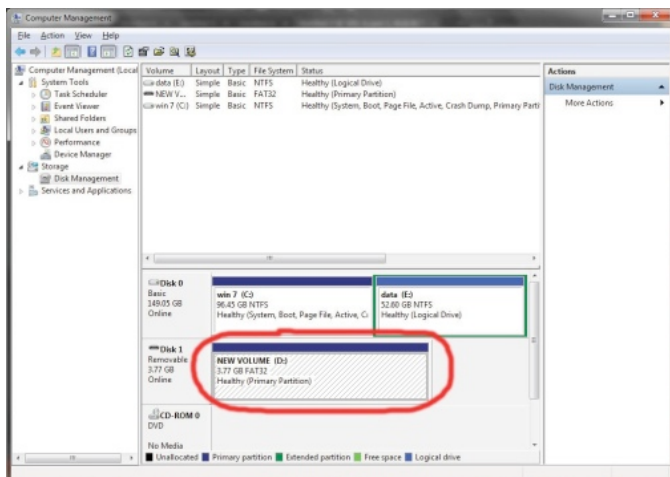

Khi hoàn thành, đèn LED **Xanh lam** sẽ sáng liên tục và DT2000 đã sẵn sàng sử dụng.

## 14. Cách cấu hình DT2000 với hệ điều hành Mac

Trong trường hợp cơ chế phát hiện tấn công đã được kích hoạt sau 10 lần nhập sai mã PIN liên tiếp hoặc USB đã được đặt lại, **tất cả dữ liệu trên thiết bị sẽ mất vĩnh viễn**.

Khi một **mã PIN người dùng** mới đã được tạo, DT2000 sẽ cần được khởi tạo và định dạng.

Để định dạng DT2000 trên máy tính chạy hệ điều hành Mac, hãy làm theo các bước sau:

1. Tạo một **mã PIN người dùng** mới (xem phần 4).
2. Mở khóa DT2000 bằng cách nhập **mã PIN người dùng** mới và kết nối với cổng USB của máy Mac. Hệ thống sẽ nhắc bạn với cửa sổ **INITIALIZE**.

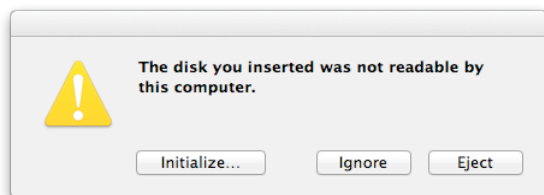

3. Ấn **INITIALIZE** và chọn DT2000 trong cửa sổ **Disk Utility**.

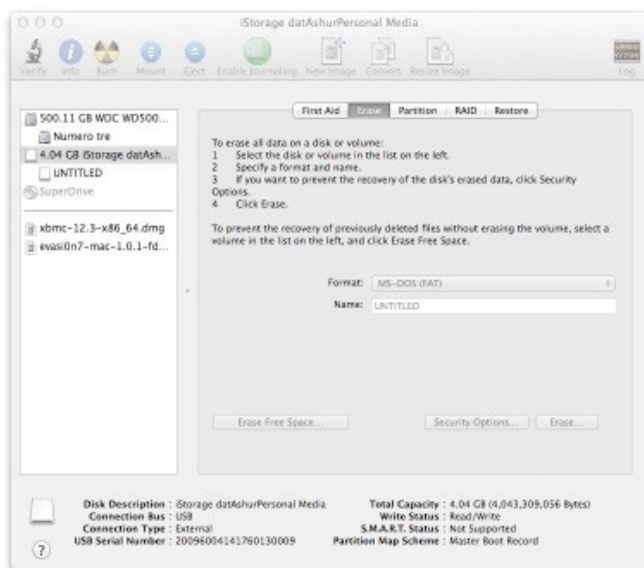

4. Nhấp vào DT2000 ở phía bên trái cửa sổ **Disk Utility**.
5. Chọn **Erase** từ trình đơn ngữ cảnh ở phía bên phải cửa sổ. Chọn **MS-DOS** cho **Volume Format**.
6. Nhấp vào **Erase**.

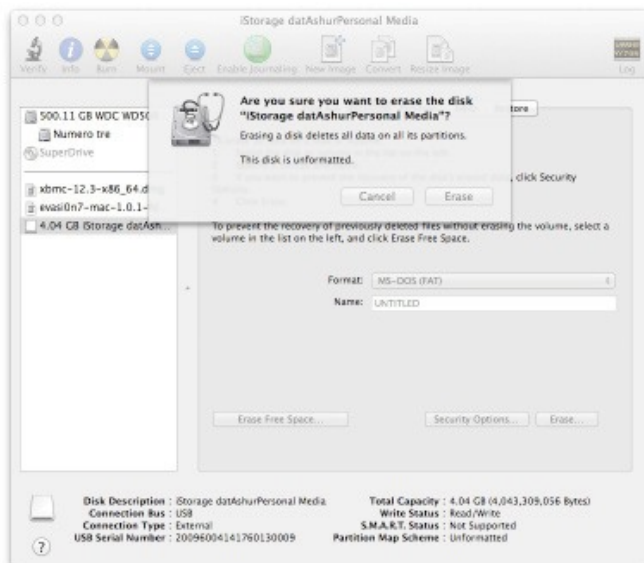

7. DT2000 đã được định dạng sẽ xuất hiện trong cửa sổ **Disk Utility** và sẽ hiện lên trên màn hình desktop.

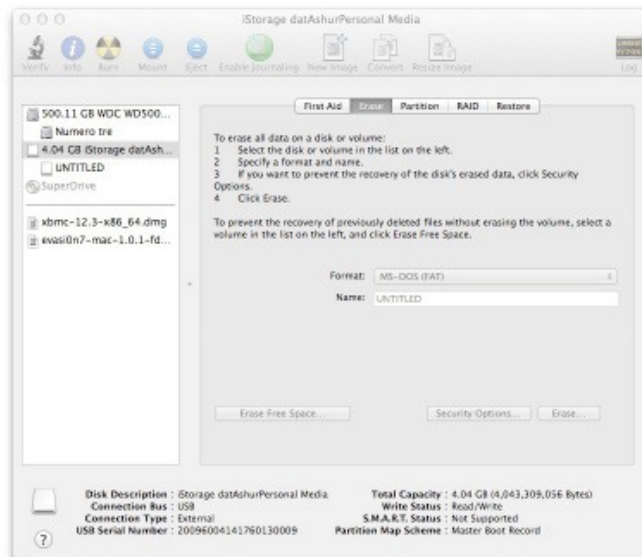

## Thông tin và cách hủy bỏ sản phẩm pin

Vui lòng không vứt bỏ sản phẩm điện tử hoặc sản phẩm có chứa pin cùng với các loại rác thải thông thường trong nhà của bạn. Các sản phẩm điện tử phải được loại bỏ một cách có trách nhiệm để giảm thiểu tác động đến môi trường. Vui lòng không nên thử tháo pin ra khỏi sản phẩm; chỉ có Kingston hoặc một nhà cung cấp dịch vụ chuyên nghiệp mới có thể làm điều này. Vui lòng liên lạc với chúng tôi để biết thêm thông tin về pin và cách tái chế sản phẩm một cách có trách nhiệm.

DataTraveler<sup>®</sup> 2000 tích hợp công nghệ DataLock<sup>®</sup> Technology do ClevX, LLC cấp phép.

## DataTraveler® 2000 - 用户手册



**记得将您的 PIN  
保存在安全位置。如果忘记或丢失，则不能访问存储在金**

如有任何问题，请参阅 DT2000 中的完整用户手册，  
也可参看金士顿网站：[kingston.com/support](http://kingston.com/support)

DataTraveler® 2000 采用了 ClevX, LLC. 许可的 DataLock® 技术。

©2016 Kingston Technology Far East Co. Ltd (Asia Headquarters) No. 1-5, Li-Hsin Rd. 1, Science Park, Hsin Chu, Taiwan, R.O.C.  
保留所有权利。所有商标与注册商标均为各自所有者之财产。

## 目录

系统要求 .....	3
介绍 .....	4
1. DT2000 布局.....	5
2. LED 指示灯及其操作 .....	5
3. 第一次如何使用 DT2000.....	6
4. 如何更改用户 PIN .....	6
5. 如何启用选项 .....	7
6. 如何启用只读模式.....	8
7. 如何启用读/写模式.....	8
8. 如何设置超时锁定模式.....	9
9. 如何禁用超时锁定模式.....	9
10. 如何确定 DT2000 版本号.....	10
11. 暴力破解入侵检测 .....	10
12. 如何重置 DT2000 .....	11
13. 如何使用 Windows 操作系统配置 DT2000 .....	12
14. 如何使用 Mac 操作系统配置 DT2000 .....	15



## 关于本手册

本用户手册用于金士顿 DataTraveler® 2000（下文简称 DT2000）。

## 系统要求

---

### PC 平台

### PC 操作系统支持

- Windows 10
  - Windows 8/8.1
  - Windows 7
  - Windows Vista® SP2
- 

### Mac 平台

### 操作系统支持

- Mac OS X 10.8.x - 10.11x
- 

### Linux 平台

### 操作系统支持

- Linux v2.6 内核+
- 

### 其他平台

### 操作系统支持

- Chrome OS™、Android\*
- 

\*仅限兼容设备。请向您的设备制造商确认是否支持 USB 闪存盘。



## 介绍



**注意：**DT2000 充电电池在开箱时并未充满电。我们建议您在首次使用前为电池充电。若要充电，将 DT2000 插入 USB 接口充电约 60 分钟，使电池充满电。

感谢您购买 DataTraveler® 2000，这是一款十分安全、易于使用的硬件加密 USB 3.0 闪存盘，通过 PIN 启动。

DT2000 采用军用级 XTS-AES 256 位硬件加密，可以实时加密闪存盘中存储的所有数据。DT2000 无需使用软件，与操作系统和主机无关。

DT2000 配备充电电池，支持用户在把闪存盘插入 USB 接口前通过板载键盘输入 7-15 位数字 PIN（个人标识号）。

如果闪存盘丢失或失窃，不必担心，DT2000 上存储的所有数据都是安全的，任何未经授权的人员都无法访问。

DT2000 通过板载键盘而非主机计算机进行解锁。因此不易受到基于软件/硬件的键记录器或暴力破解攻击的伤害。









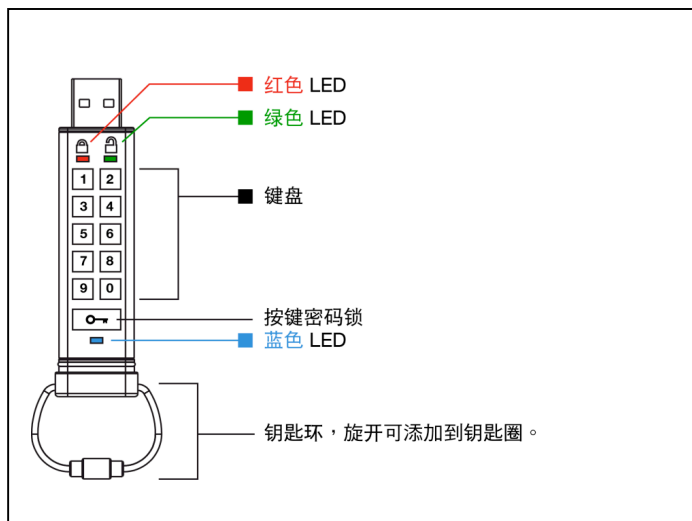







**小心：**DT2000 的出厂默认 PIN 是  1-1-2-2-3-3-4-4  尽管您可以直接使用默认 PIN，但出于安全考虑，我们强烈建议您按照第 4 部分“如何更改用户 PIN”中的说明**立即创建新的用户 PIN**。

如果忘记自己的 PIN，您将无法访问任何数据。

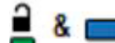
## 1. DT2000 布局





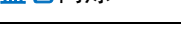

## 2. LED 指示灯及其操作

LED	LED 状态	说明	LED 状态	说明	说明
	<b>红色</b> 黑色淡出 	正在锁定/不正确的 PIN 输入		<b>红色</b> 和 <b>绿色</b> 交替闪烁 	出厂重置
	<b>红色</b> 闪烁 	已锁定并在等待输入出厂默认 PIN 或定义的 PIN			
	<b>绿色</b> 常亮 	DT2000 已解锁		<b>绿色</b> 和 <b>蓝色</b> 同时闪烁 	用户选项模式
	<b>绿色</b> 闪烁 	当插入 USB 端口时，如果 <b>绿色</b> LED 每 2 秒闪烁一次，这表示 DT2000 已被设为“只读”。			
	<b>蓝色</b> 常亮 	已插入 USB 端口			
	<b>蓝色</b> 闪烁 	与主机交换数据/正在更改用户 PIN			

### 3. 第一次如何使用 DT2000

DT2000 的出厂默认 PIN 是 11223344，尽管您可以直接使用默认 PIN，但出于安全考虑，我们强烈建议您按照第 4 部分“如何更改用户 PIN”中的说明立即创建新 PIN。

请按照下表中的 3 个简单步骤，使用默认 PIN 解锁 DT2000。

说明（首次使用）	LED	LED 状态
1. 按下钥匙按钮一次 		红色、绿色和蓝色三个 LED 将同时闪烁一次，随后红色 LED 将继续闪烁。
2. 在 10 秒内，输入用户 PIN 默认 - 11223344）以解锁 DT2000		红色 LED 将继续闪烁
3. 按下钥匙按钮一次 		红色常亮 LED 变为绿色常亮 LED，表示已成功输入默认用户 PIN



**注意：**一旦 DT2000 成功解锁，绿色 LED 将继续亮起并且仅保持常亮状态 30 秒钟，在此期间需将 DT2000 插入 USB 端口。通过按住钥匙按钮  3 秒钟、等待 30 秒到期或在您的操作系统中单击“安全删除硬件并弹出媒体”图标，可以立即锁定闪存盘。

### 4. 如何更改用户 PIN

PIN 要求：













- 长度必须是 7-15 位数字
- 不得仅包含重复数字，例如 (3-3-3-3-3-3)
- 不得仅包含连续数字，例如 (1-2-3-4-5-6-7)、(7-8-9-0-1-2-3-4)、(7-6-5-4-3-2-1)

**密码提示：**只需按下包含对应字母的按键，就可以创建容易记住的单词、名字、短语或任何其他字母数字 PIN 组合。

这种类型的字母数字 PIN 示例包括：

- 对于“password”，您需要按下以下按键：  
7 (pqrs) 2 (abc) 7 (pqrs) 7 (pqrs) 9 (wxyz) 6 (mno) 7 (pqrs) 3 (def)
- 对于“kingston”，您需要按下：  
5 (jkl) 4 (ghi) 6 (mno) 4 (ghi) 7 (pqrs) 8 (tuv) 6 (mno) 6 (mno)

利用这种方法，可以创建易于记住的长 PIN。

说明	LED	LED 状态
1. 按下钥匙按钮一次 		红色、绿色和蓝色三个 LED 将同时闪烁一次，随后红色 LED 将继续闪烁。
2. 在 10 秒内，开始输入用户 PIN（默认 - 11223344）以解锁 DT2000		红色 LED 将继续闪烁
3. 按下钥匙按钮一次 		红色常亮 LED 变为绿色常亮 LED，表示已成功输入默认用户 PIN
4. 按下钥匙按钮两次（双击）  		蓝色 LED 闪烁
5. 在 10 秒内，开始输入新用户 PIN		蓝色 LED 继续闪烁
6. 按下钥匙按钮两次（双击）  		绿色 LED 闪烁
7. 在 10 秒内，开始重新输入新用户 PIN		绿色 LED 继续闪烁
8. 按下钥匙按钮两次（双击）  		红色常亮 LED 变为绿色常亮 LED，表示已成功更改用户 PIN











**注意：**如果在定义新用户 PIN 时出错或该程序没有完成，闪存盘将保留旧 PIN。

## 5. 如何启用选项





选项模式支持用户执行各种不同的功能，例如启用或禁用 DT2000 “只读”、设置“超时”自动锁定，以及确定设备版本。

下表描述了如何访问选项 模式第 6 - 9 部分描述了如何 执行各种不同的功能。

说明	LED	LED 状态
1. 按下钥匙按钮一次 		红色、绿色和蓝色三个 LED 将同时闪烁一次，随后红色 LED 将继续 闪烁
2. 在 10 秒内，输入用户 PIN（默认 - 11223344）以解锁 DT2000		红色 LED 将继续闪烁
3. 按下钥匙按钮一次 		红色常亮 LED 变为绿色常亮 LED，表示已成功输入用户 PIN
4. 按下钥匙按钮三次（三击）   		绿色和蓝色 LED 同时闪烁，等待选项模式中的新指令。

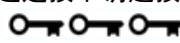
## 6. 如何启用只读模式

DT2000 拥有只读模式，可以限制对闪存盘进行写入访问。这可以通过执行以下步骤完成。

说明	LED	LED 状态
1. 使用用户 PIN 解锁 DT2000		<b>红色</b> 常亮 LED 变为 <b>绿色</b> 常亮 LED，表示已成功输入用户 PIN
2. 通过按下钥匙按钮三次（三击）启用选项 		<b>绿色</b> 和 <b>蓝色</b> LED 同时闪烁，等待选项模式中的新指令。
3. 在 10 秒内，先后按下数字 7 (pqrs) 按钮和数字 6 (mno) 按钮 (76)		<b>绿色</b> 和 <b>蓝色</b> LED 继续同时闪烁
4. 按下钥匙按钮一次 		<b>蓝色</b> LED 快速淡出为常亮 <b>绿色</b> - 当 DT2000 插入 USB 端口时， <b>绿色</b> LED 每两秒闪烁一次，表示闪存盘处于只读模式





一旦激活，在禁用写保护前，仅限以只读模式进行访问。

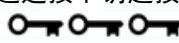

**注意：**我们使用一种命名规则，让用户可以轻松记住每个可选设置的按键。在上表中，我们使用了代表可选功能名称首字母的数字。例如 **Read-Only**（只读）= 7 (pqrs) 6 (mno)。

## 7. 如何启用读/写模式

可以关闭受限的写保护（只读）访问，将访问模式切换为读/写模式。这可以通过执行以下步骤完成。

说明	LED	LED 状态
1. 使用用户 PIN 解锁 DT2000		<b>红色</b> 常亮 LED 变为 <b>绿色</b> 常亮 LED，表示已成功输入用户 PIN
2. 通过按下钥匙按钮三次（三击）启用选项 		<b>绿色</b> 和 <b>蓝色</b> LED 同时闪烁，等待选项模式中的新指令。
3. 在 10 秒内，先后按下数字 7 (pqrs) 按钮和数字 9 (wxyz) 按钮 (79)		<b>绿色</b> 和 <b>蓝色</b> LED 继续同时闪烁
4. 按下钥匙按钮一次 		<b>蓝色</b> LED 快速淡出为常亮 <b>绿色</b> - 当 DT2000 插入 USB 端口时， <b>绿色</b> LED 每两秒闪烁一次，表示闪存盘处于读/写模式







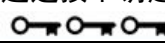

一旦激活，访问模式将恢复为默认的读/写状态。

## 8. 如何设置超时锁定模式

当 DT2000 插入主机且无人看管时，为防范未经授权的访问，DT2000 可以设为在预设时间后自动锁定。







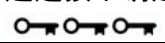

在默认状态下，DT2000 超时锁定功能处于关闭状态。超时锁定功能可以设为在 1 至 99 分钟不等的时间后激活（锁定）。

若要设置超时锁定，请按照下表中的步骤进行操作。







说明	LED	LED 状态
1. 使用用户 PIN 解锁 DT2000		红色常亮 LED 变为绿色常亮 LED，表示已成功输入用户 PIN
2. 通过按下钥匙按钮三次（三击）启用选项 		绿色和蓝色 LED 同时闪烁，等待选项模式中的新指令
3. 在 10 秒内，先后按下数字 8 (tuv) 按钮和数字 5 (jkl) 按钮 - (85)		绿色和蓝色 LED 继续同时闪烁
4. 按下钥匙按钮一次 		闪烁的绿色 LED
5. 在 10 秒内，输入两位数的用户超时长度： 00 = 0 分钟（默认） 01 = 1 分钟 99 = 99 分钟等等		绿色 LED 继续闪烁
6. 按下钥匙按钮一次 		绿色常亮 LED - 超时锁定功能已启用

## 9. 如何禁用超时锁定模式

若要禁用超时锁定，请按照下表中的步骤进行操作。

说明	LED	LED 状态
1. 使用用户 PIN 解锁 DT2000		红色常亮 LED 变为绿色常亮 LED，表示已成功输入用户 PIN
2. 通过按下钥匙按钮三次（三击）启用选项 		绿色和蓝色 LED 同时闪烁，等待选项模式中的新指令
3. 在 10 秒内，先后按下数字 8 (tuv) 按钮和数字 5 (jkl) 按钮 - (85)		绿色和蓝色 LED 继续同时闪烁
4. 按下钥匙按钮一次 		闪烁的绿色 LED
5. 在 10 秒内，按下数字 0 按钮两次（双击） （零零） - (00)		绿色 LED 继续闪烁
6. 按下钥匙按钮一次 		绿色常亮 LED - 超时锁定功能已禁用

## 10. 如何确定 DT2000 版本号

说明	LED	LED 状态
1. 使用用户 PIN 解锁 DT2000		红色常亮 LED 变为绿色常亮 LED，表示已成功输入用户 PIN
2. 通过按下钥匙按钮三次（三击）启用选项 		绿色和蓝色 LED 同时闪烁，等待选项模式中的新指令
3. 在 10 秒内，先后按下数字 8 (tuv) 按钮和数字 6 (mno) 按钮 - (86)		绿色和蓝色 LED 继续同时闪烁
4. 按下钥匙按钮一次 	 	红色、绿色和蓝色三个 LED 将同时快速闪烁，接着红色 LED 将根据版本的第一个有效数字闪烁相应次数，随后绿色 LED 将根据版本号的第二个有效数字闪烁。

例如，如果版本号是“1.8”，红色 LED 将闪烁一 (1) 次，而绿色 LED 将闪烁八 (8) 次。当这个过程结束时，红色、绿色和蓝色 LED 将同时闪烁一次，随后绿色将变成常亮状态。

## 11. 暴力破解入侵检测



**小心：**如果用户连续 10（十）次输入不正确的用户 PIN，DT2000 的暴力破解机制将被触发，用户 PIN、加密密钥以及所有数据将被删除并永久丢失。

用于解锁 DT2000 的 PIN	在连续 10 次输入不正确的 PIN 后，会出现什么情况？
用户 PIN	DT2000 的暴力破解机制将被触发，用户 PIN、加密密钥以及所有数据将被删除并永久丢失。

如果用户连续 10（十）次输入不正确的用户 PIN，加密密钥和所有数据将被删除并永久丢失。DT2000 将随后恢复为出厂默认用户 PIN 11223344 - 参阅第 6 页第 4 部分，了解如何更改用户 PIN。此外，由于这将强制创建新加密密钥，DT2000 必须进行重新格式化（参阅第 13 或 14 部分）。

与其他类似闪存盘不同，DT2000 采用了随机数生成器。一旦闪存盘重置，将随机生成新的加密密钥。









## 12. 如何重置 DT2000

如果忘记用户 PIN，或用户希望删除 DT2000 中存储的所有数据，请按照下述说明进行操作。

重置过程将清除所有加密参数，包括用户 PIN。这意味着 DT2000 将恢复为默认用户 PIN 11223344 - 参阅第 6 页第 4 部分，了解如何更改用户 PIN。此外，由于这将强制创建新加密密钥，DT2000 必须进行重新格式化（参阅第 13 或 14 部分）。



**小心：**对 DT2000 进行重置操作将删除闪存盘中存储的所有数据。

说明	LED	LED 状态
1. 按住数字 7 (pqrs) 按钮，随后按下钥匙  按钮。 释放按钮（7 和  ）	 / 	红色和绿色 LED 交替闪烁
2. 在 10 秒内，按下数字 9 (wxyz) 按钮三次（三击）(999)	 / 	红色和绿色 LED 继续交替闪烁
3. 按住数字 7 (pqrs) 按钮，随后按下 钥匙  按钮。 释放按钮（7 和  ）		红色 LED 淡出以完成重置过程



## 13. 如何使用 Windows 操作系统配置 DT2000

如果因连续 10 次输入不正确的 PIN 而触发入侵检测，或闪存盘已重置，**闪存盘中的所有数据将永久丢失。**

一旦新用户 PIN 创建完成，DT2000 将需要进行初始化和格式化。

若要初始化 DT2000，按照以下步骤进行操作：

1. 创建新用户 PIN（参阅第 4 部分）。
2. 通过输入新用户 PIN 解锁 DT2000 并将其插入计算机 USB 端口。
3. 计算机将向用户提示以下信息：

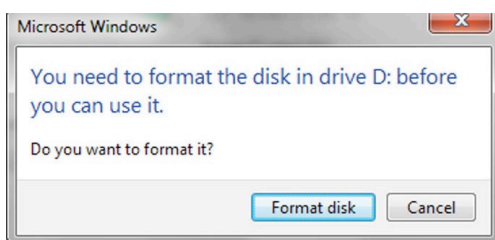

4. 单击**格式化磁盘**继续。  
根据需要选择 **FAT32** 或 **NTFS**，输入卷标并单击**开始**。

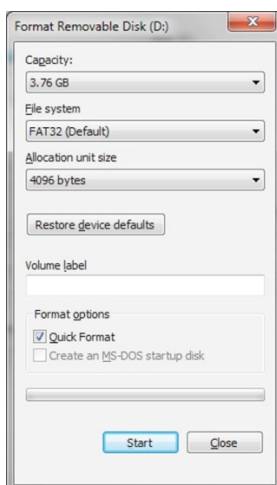

5. 单击**确定**继续格式化闪存盘。

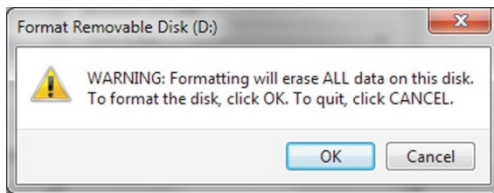

**警告：** 此程序将擦除闪存盘中存储的所有数据。

6. 计算机将完成闪存盘格式化并确认格式化已完成。在 DT2000 格式化过程中，**蓝色** LED 将闪烁。

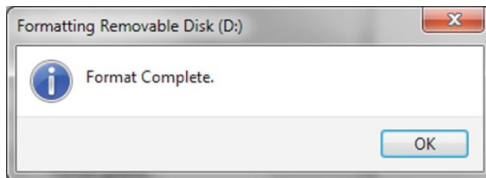

一旦完成，**蓝色** LED 将变成常亮状态，DT2000 可供使用。

如果格式化向导没有出现，请按照以下程序进行操作：

1. 右击**我的电脑**或**计算机**，然后单击**管理**。
2. 在**计算机管理**窗口的**磁盘管理**选项卡中，DT2000 被识别为原始格式的可移除设备。

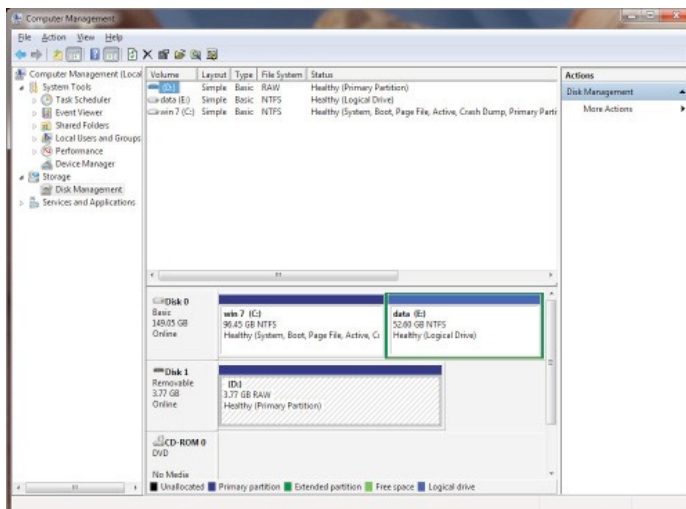

3. 在未分配部分的空白区域，右击可移除原始磁盘并选择格式化。

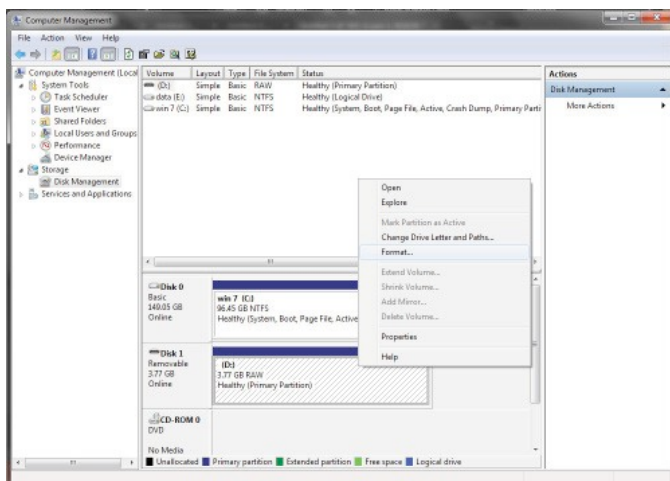

4. 格式化窗口将打开。  
输入新卷标。  
根据需要选择 FAT32 或 NTFS 并单击确定。

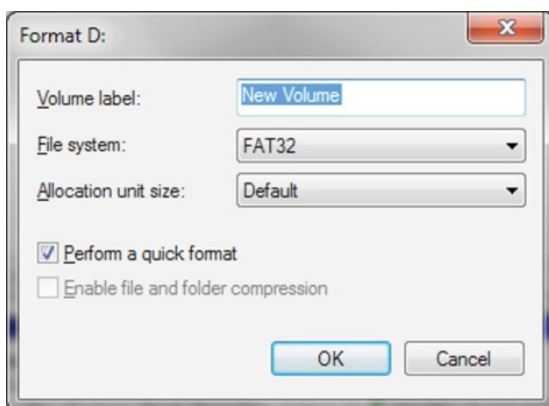

5. 单击格式化警告窗口中的确定，继续格式化闪存盘。

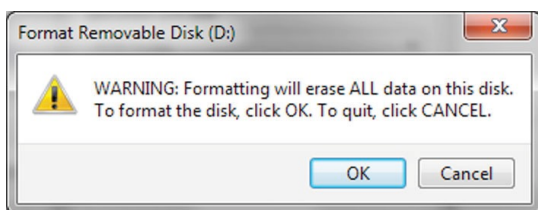

 **警告：** 此程序将清除闪存盘中存储的所有数据。

6. 计算机将完成格式化并返回**磁盘管理**窗口。

在 DT2000 格式化过程中，**蓝色** LED 将开始闪烁。

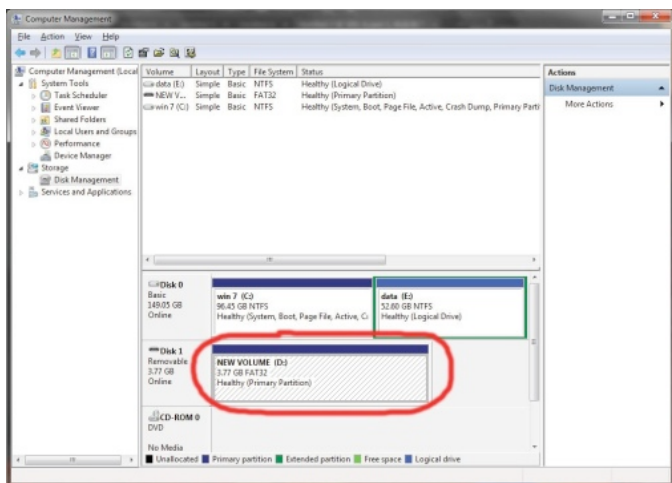

当完成时，**蓝色** LED 将变成常亮状态，DT2000 可供使用。

## 14. 如何使用 Mac 操作系统配置 DT2000

如果因连续 10 次输入不正确的 PIN 而触发入侵检测，或闪存盘已重置，**闪存盘中的所有数据将永久丢失。**

一旦新用户 PIN 创建完成，DT2000 将需要进行初始化和格式化。

若要在 Mac 操作系统计算机上格式化 DT2000，按照以下步骤进行操作：

1. 创建新用户 PIN（参阅第 4 部分）。
2. 通过输入新用户 PIN 解锁 DT2000 并将其插入 Mac 计算机 USB 端口。系统将弹出**初始化**窗口。

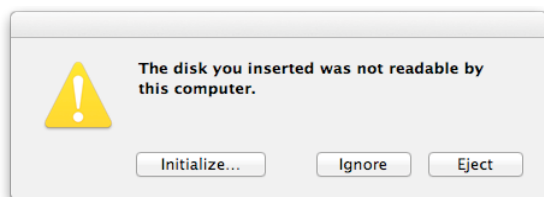

3. 按下初始化并在磁盘工具窗口中选择 DT2000。

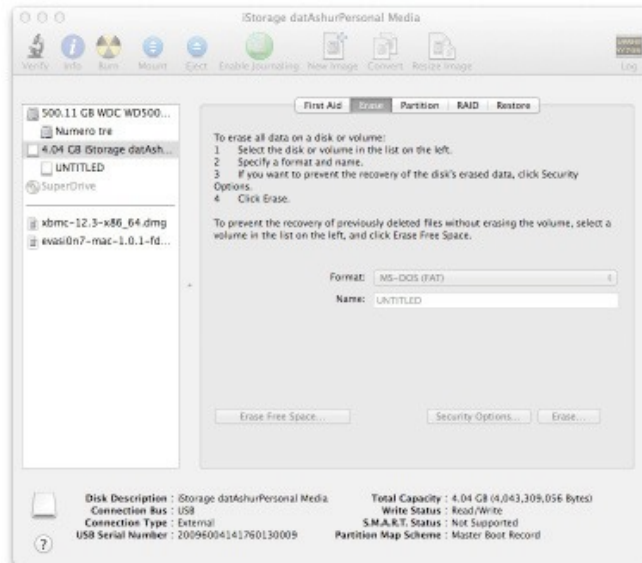

4. 单击磁盘工具窗口左侧的 DT2000。
5. 从窗口右侧的上下文菜单中选择抹掉。为卷格式选择 MS-DOS。
6. 单击抹掉。

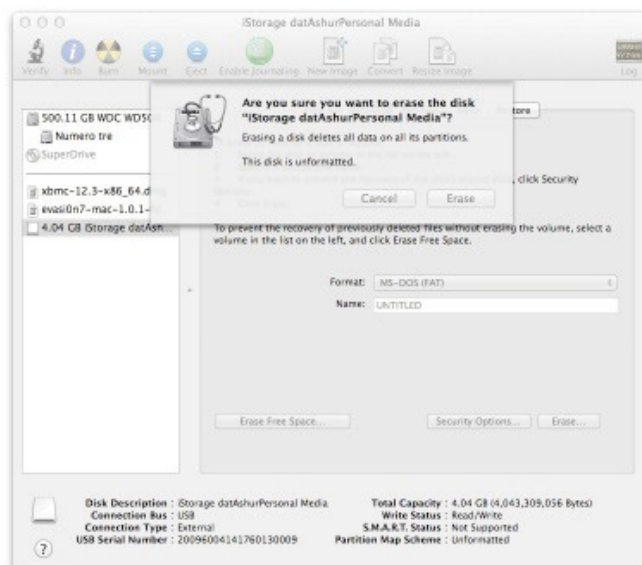

7. 格式化的 DT2000 将出现在**磁盘工具**窗口中，并将加载到桌面。

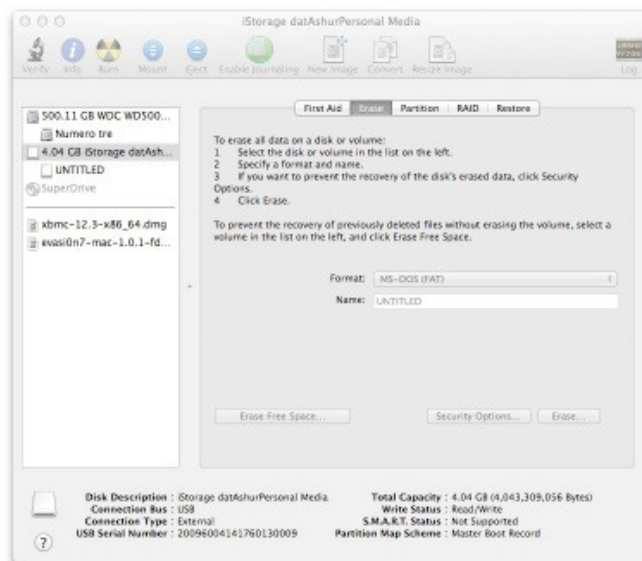

## 电池信息/产品处理

请不要将电气产品或包含电池的产品废弃物与普通生活垃圾一起丢弃。必须以负责任的方式处理电子产品，以最大程度地降低环境影响。请不要尝试从产品中取出电池；只能由金士顿或其它专业服务来取出电池。请[联系我们](#)，获取更多有关电池以及如何负责任的方式回收产品的相关信息。

DataTraveler® 2000 采用了 ClevX, LLC. 许可的 DataLock® 技术。

## DataTraveler® 2000 - 使用手冊



**請務必將 PIN 碼儲存到安全的位置。如果遺失或忘記 PIN 碼，您就無法存取儲存在 Kingston DataTraveler® 上的資料。**

如果您有任何疑問，請參閱 DT2000 中載入的這份完整使用者手冊，手冊內容也可於 Kingston 網站取得。 [kingston.com/support](http://kingston.com/support)

DataTraveler® 2000 整合了 ClevX, LLC 授權的 DataLock® 技術。

## 目錄

系統需求 .....	3
產品介紹 .....	4
1. DT2000 配置 .....	5
2. LED 指示燈及其動作 .....	5
3. 首次使用 DT2000 的方法 .....	6
4. 如何變更使用者 PIN 碼 .....	6
5. 如何啟用選項 .....	7
6. 如何啟用唯讀模式 .....	8
7. 如何啟用讀取/寫入模式 .....	8
8. 如何設定逾時鎖定模式 .....	9
9. 如何停用逾時鎖定模式 .....	9
10. 如何判定 DT2000 版本號碼 .....	10
11. 暴力攻擊駭客偵測 .....	10
12. 如何重設 DT2000 .....	11
13. 如何使用 Windows OS 設定 DT2000 .....	12
14. 如何使用 Mac OS 設定 DT2000 .....	15



## 關於本手冊

本使用者手冊適用於 Kingston 的 DataTraveler® 2000 (以下稱為 DT2000)。

## 系統需求

---

### 電腦平台

### PC 作業系統支援

- Windows 10
  - Windows 8/8.1
  - Windows 7
  - Windows Vista® SP2
- 

### Mac 平台

### 作業系統支援

- Mac OS X 10.8.x - 10.11x
- 

### Linux 平台

### 作業系統支援

- Linux v2.6 kernel+
- 

### 其他平台作業系統支援

- Chrome OS™、Android\*
- 

\*僅適用於相容的裝置。請諮詢裝置的製造商以瞭解其是否支援 USB 隨身碟。

## 產品介紹



**注意：**DT2000 充電式電池在首次使用時並非充滿電的狀態。建議您在首次使用前先為電池充電。若要充電，請將 DT2000 插入供電的 USB 連接埠 60 分鐘，就能將電池電力充飽。

感謝您購買 DataTraveler® 2000 - 具超高安全性且易於使用的硬體加密 USB 3.0 PIN 啟動隨身碟。



DT2000 使用軍用等級 XTS-AES 256 位元硬體加密，其會對儲存在隨身碟上的所有資料進行即時加密。DT2000 不需要任何軟體，而且與 OS 和主機毫不相關。

DT2000 使用充電式電池，可讓使用者先在內建數字鍵盤上輸入 7 到 15 位數的 PIN 碼 (個人識別碼)，然後再將隨身碟連接到 USB 連接埠。

若隨身碟遺失或遭竊，儲存在 DT2000 上的所有資料將安全無虞且任何未經授權的人員均不得存取內容，可讓使用者無後顧之憂。

DT2000 可透過內建數字鍵盤 (而非主機電腦) 解鎖，不可抵禦以軟體/硬體為基礎之鍵盤側錄程序或暴力攻擊的入侵。







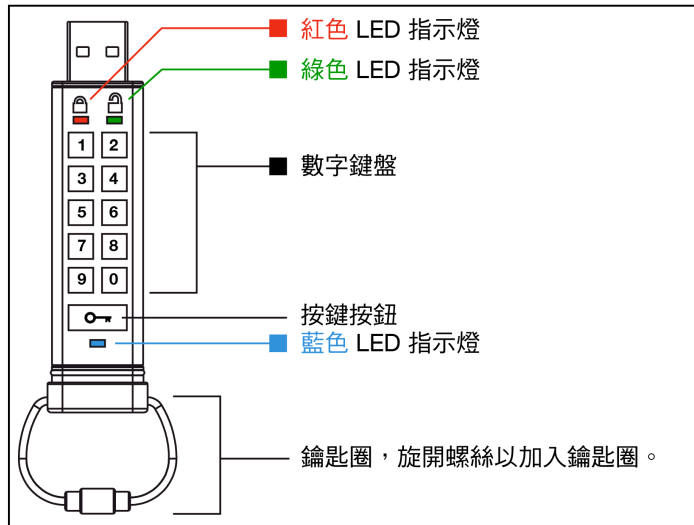









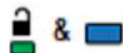

**注意：**DT2000 隨附預設的 PIN 碼，使用者 PIN 碼為  1-1-2-2-3-3-4-4 ，而且雖然可透過預設 PIN 碼立即使用，基於安全考量，我們強烈建議您依照第 4 節「如何變更使用者 PIN 碼」，立即建立新的使用者 PIN 碼。如果您忘記 PIN 碼，則將無法存取所有資料。

## 1. DT2000 配置



## 2. LED 指示燈及其動作

LED 指示燈	LED 指示燈狀態	說明	LED 指示燈狀態	說明	說明
	<b>紅色</b> 黑色淡出 	鎖定/輸入不正確的 PIN 碼		<b>紅色</b> 和 <b>綠色</b> 交互閃爍 	原廠重設
	<b>紅色</b> 閃爍 	鎖定並等候原廠預設 PIN 碼或是輸入定義的 PIN 碼			
	<b>綠色</b> 恆亮 	DT2000 未鎖定		<b>綠色</b> 和 <b>藍色</b> 同時閃爍 	使用者選項模式
	<b>綠色</b> 閃爍 	連接至 USB 連接埠時，如果 <b>綠色</b> LED 指示燈每隔 2 秒閃爍一次，則表示 DT2000 已經被設定為「唯讀」			
	<b>藍色</b> 恆亮 	連接至 USB 連接埠			
	<b>藍色</b> 閃爍 	使用主機/變更使用者 PIN 碼來交換資料			

### 3. 首次使用 DT2000 的方法

DT2000 隨附 11223344 的預設 PIN 碼，而且雖然可透過預設 PIN 碼立即使用，基於安全考量，我們強烈建議您依照第 4 節「如何變更使用者 PIN 碼」，立即建立新的使用者 PIN 碼。

請依照下表中的 3 個簡單步驟，使用預設 PIN 碼來解鎖 DT2000。

指示 (首次使用)	LED 指示燈	LED 指示燈狀態
1. 按下 KEY 按鈕一次 		紅色、綠色和藍色 LED 指示燈會同時閃爍一次，然後紅色 LED 指示燈會持續閃爍
2. 在 10 秒內輸入使用者 PIN 碼 (預設值 - 11223344) 以解鎖 DT2000		紅色 LED 指示燈會持續閃爍
3. 按下 KEY 按鈕一次 		紅色恆亮 LED 指示燈變成綠色恆亮 LED 指示燈，這表示已成功輸入預設的使用者 PIN 碼



**注意：**一旦成功解鎖 DT2000，綠色 LED 指示燈便會維持開啟狀態且僅會恆亮 30 秒，而在這段期間，您必須將 DT2000 連接到 USB 連接埠。按下並按住 KEY 按鈕 (  ) 3 秒就能立即鎖定，或是等候 30 秒以過期，或是按一下作業系統中的「安全地移除硬體並退出媒體」圖示。

### 4. 如何變更使用者 PIN 碼

PIN 碼要求：

- 長度必須是介於 7 到 15 個之間的數字
- 不得只包含重複的號碼，例如 (3-3-3-3-3-3)
- 不得只包含連續數字，例如 (1-2-3-4-5-6-7)、(7-8-9-0-1-2-3-4)、(7-6-5-4-3-2-1)















**密碼提示：**只要按下按鍵和對應的字母，您就能建立容易記憶的字詞，名稱、片語或任何其他字母數字 PIN 碼組合。

這些字母數字 PIN 碼類型的範例為：

- 以「password」為例，請按下下列按鍵：  
7 (pqrs) 2 (abc) 7 (pqrs) 7 (pqrs) 9 (wxyz) 6 (mno) 7 (pqrs) 3 (def)
- 以「kingston」為例，請按下：

5 (jkl) 4 (ghi) 6 (mno) 4 (ghi) 7 (pqrs) 8 (tuv) 6 (mno) 6 (mno)

使用此方法，就能建立長但容易記憶的 PIN 碼。









指示	LED 指示燈	LED 指示燈狀態
1. 按下 KEY 按鈕一次 		<b>紅色</b> 、 <b>綠色</b> 和 <b>藍色</b> LED 指示燈會同時閃爍一次，然後 <b>紅色</b> LED 指示燈會持續閃爍
2. 在 10 秒內開始輸入使用者 PIN 碼 (預設值 - 11223344) 以解鎖 DT2000		<b>紅色</b> LED 指示燈會持續閃爍
3. 按下 KEY 按鈕一次 		<b>紅色</b> 恆亮 LED 指示燈變成 <b>綠色</b> 恆亮 LED 指示燈，這表示已成功輸入預設的使用者 PIN 碼
4. 快速連接 KEY 按鈕兩次  		<b>藍色</b> LED 指示燈閃爍
5. 在 10 秒內開始輸入新的使用者 PIN 碼		<b>藍色</b> LED 指示燈持續閃爍
6. 按下 KEY 按鈕兩次 (連接兩下)  		<b>綠色</b> LED 指示燈閃爍
7. 在 10 秒內開始重新輸入新的使用者 PIN 碼		<b>綠色</b> LED 指示燈持續閃爍
8. 按下 KEY 按鈕兩次 (連接兩下)  		<b>紅色</b> 恆亮 LED 指示燈變成 <b>綠色</b> 恆亮 LED 指示燈，這表示已成功變更使用者 PIN 碼



**注意：**如果定義新使用者 PIN 碼時發生錯誤或是該程序未完成，隨身碟仍會保留舊的 PIN 碼。











## 5. 如何啟用選項

「選項」模式可讓使用者執行不同的功能，例如以「唯讀」模式啟用或停用 DT2000、設定「逾時」自動鎖定，以及判定裝置的版本。

指示	LED 指示燈	LED 指示燈狀態
1. 按下 KEY 按鈕一次 		<b>紅色</b> 、 <b>綠色</b> 和 <b>藍色</b> LED 指示燈會同時閃爍一次，然後 <b>紅色</b> LED 指示燈會持續閃爍
2. 在 10 秒內輸入使用者 PIN 碼 (預設值 - 11223344) 以解鎖 DT2000		<b>紅色</b> LED 指示燈會持續閃爍
3. 按下 KEY 按鈕一次 		<b>紅色</b> 恆亮 LED 指示燈變成 <b>綠色</b> 恆亮 LED 指示燈，這表示已成功輸入使用者 PIN 碼
4. 快速連接 KEY 按鈕 3 次   		<b>綠色</b> 和 <b>藍色</b> LED 指示燈會同時閃爍，以等候「選項」模式中的新指示。

## 6. 如何啟用唯讀模式

DT2000 具備唯讀模式，可限制他人寫入隨身碟。執行下列步驟即可此操作。

指示	LED 指示燈	LED 指示燈狀態
1. 使用使用者 PIN 碼解鎖 DT2000	 → 	<b>紅色</b> 恆亮 LED 指示燈變成 <b>綠色</b> 恆亮 LED 指示燈，這表示已成功輸入使用者 PIN 碼
2. 快速連按 KEY 按鈕 3 次  以啟用選項	 & 	<b>綠色</b> 和 <b>藍色</b> LED 指示燈會同時閃爍，以等候「選項」模式中的新指示。
3. 在 10 秒內開始按下數字 7 (pqrs)，然後按數字 6 (mno) 按鈕 (76)	 & 	<b>綠色</b> 和 <b>藍色</b> LED 指示燈會持續同時閃爍
4. 按下 KEY 按鈕一次 	 → 	<b>藍色</b> LED 指示燈會快速淡出為恆亮 <b>綠色</b> - 將 DT2000 插入 USB 連接埠時， <b>綠色</b> LED 指示燈會每隔兩秒閃爍一次，這代表隨身碟處於「唯讀」模式











啟動之後，存取權限便會限制為「唯讀」，直到您停用寫入保護為止。



**注意：**我們已運用命名慣例，讓使用者能輕鬆記住每個選項設定的按鍵。在上表中，我們使用了代表選項功能名稱第一個字母的數字。例如，**Read-Only** = 7 (pqrs) 6 (mno)。

## 7. 如何啟用讀取/寫入模式

將存取權限恢復為「讀取/寫入」之後，即可關閉限制寫入保護 (唯讀) 存取。執行下列步驟即可此操作。

指示	LED 指示燈	LED 指示燈狀態
1. 使用使用者 PIN 碼解鎖 DT2000	 → 	<b>紅色</b> 恆亮 LED 指示燈變成 <b>綠色</b> 恆亮 LED 指示燈，這表示已成功輸入使用者 PIN 碼
2. 快速連按 KEY 按鈕 3 次  以啟用選項	 & 	<b>綠色</b> 和 <b>藍色</b> LED 指示燈會同時閃爍，以等候「選項」模式中的新指示。
3. 在 10 秒內輸入數字 7 (pqrs)，然後輸入數字 9 (wxyz) 按鈕 (79)	 & 	<b>綠色</b> 和 <b>藍色</b> LED 指示燈會持續同時閃爍
4. 按下 KEY 按鈕一次 	 → 	<b>藍色</b> LED 指示燈會快速淡出為恆亮 <b>綠色</b> - 將 DT2000 插入 USB 連接埠時， <b>綠色</b> LED 指示燈會每隔兩秒閃爍一次，這代表隨身碟處於「讀取/寫入」模式









啟動之後，存取權限便會恢復為預設的「讀取/寫入」狀態。

## 8. 如何設定逾時鎖定模式

為了防止未經授權人員存取隨身碟，將 DT2000 連接至主機且無人看管時，可以將 DT2000 設定為經過預設時間之後自動鎖定。



在其預設狀態中，會關閉 DT2000「逾時鎖定」功能。「逾時鎖定」功能可以設定為在介於 1 到 99 分鐘期間，在任何地方啟動 (鎖定)。

若要設定「逾時鎖定」，請依照下表中的步驟。







指示	LED 指示燈	LED 指示燈狀態
1. 使用使用者 PIN 碼解鎖 DT2000		紅色恆亮 LED 指示燈變成綠色恆亮 LED 指示燈，這表示已成功輸入使用者 PIN 碼
2. 按下 KEY 按鈕 3 次 (連按三下) 以啟用選項 		綠色和藍色 LED 指示燈會同時閃爍，以等候「選項」模式中的新指示。
3. 在 10 秒內輸入數字 8 (tuv)，然後輸入數字 5 (jkl) 按鈕 - (85)		綠色和藍色 LED 指示燈會持續同時閃爍
4. 按下 KEY 按鈕一次 		閃爍的綠色 LED 指示燈
5. 在 10 秒內輸入 2 位數的「使用者逾時」長度： 00 = 0 分鐘 (預設值) 01 = 1 分鐘 99 = 99 分鐘等		綠色 LED 指示燈持續閃爍
6. 按下 KEY 按鈕一次 		綠色恆亮 LED 指示燈 - 已啟用「逾時鎖定」

## 9. 如何停用逾時鎖定模式

若要停用「逾時鎖定」，請依照下表中的步驟。

指示	LED 指示燈	LED 指示燈狀態
1. 使用使用者 PIN 碼解鎖 DT2000		紅色恆亮 LED 指示燈變成綠色恆亮 LED 指示燈，這表示已成功輸入使用者 PIN 碼
2. 快速連按 KEY 按鈕 3 次  以啟用選項		綠色和藍色 LED 指示燈會同時閃爍，以等候「選項」模式中的新指示。
3. 在 10 秒內輸入數字 8 (tuv)，然後輸入數字 5 (jkl) 按鈕 - (85)		綠色和藍色 LED 指示燈會持續同時閃爍
4. 按下 KEY 按鈕一次 		閃爍的綠色 LED 指示燈
5. 在 10 秒內，輸入數字 0 按鈕兩次 (連按兩下) (zero zero) - (00)		綠色 LED 指示燈持續閃爍
6. 按下 KEY 按鈕一次 		綠色恆亮 LED 指示燈 - 已停用「逾時鎖定」

## 10. 如何判定 DT2000 版本號碼

指示	LED 指示燈	LED 指示燈狀態
1. 使用使用者 PIN 碼解鎖 DT2000		<b>紅色</b> 恆亮 LED 指示燈變成 <b>綠色</b> 恆亮 LED 指示燈，這表示已成功輸入使用者 PIN 碼
2. 快速連按 KEY 按鈕 3 次 		<b>綠色</b> 和 <b>藍色</b> LED 指示燈會同時閃爍，以等候「選項」模式中的新指示。
3. 在 10 秒內輸入數字 <b>8</b> (tuv)，然後輸入數字 <b>6</b> (mno) 按鈕 - (86)		<b>綠色</b> 和 <b>藍色</b> LED 指示燈會持續同時閃爍
4. 按下 KEY 按鈕一次 	 	<b>紅色</b> 、 <b>綠色</b> 和 <b>藍色</b> LED 指示燈會同時快速閃爍一次，之後 <b>紅色</b> LED 指示燈會閃爍修訂版第一個重要數字的次數，而 <b>綠色</b> LED 指示燈則會閃爍修訂版號碼的第二個重要數字的次數。
例如，如果修訂版的號碼是「1.8」， <b>紅色</b> LED 指示燈則會閃爍一 (1) 次，而 <b>綠色</b> LED 指示燈則會閃爍八 (8) 次。順序結束時， <b>紅色</b> 、 <b>綠色</b> 和 <b>藍色</b> LED 指示燈會同時閃爍一次，之後 <b>綠色</b> 指示燈則會恆亮。		

## 11. 暴力攻擊駭客偵測



**注意：** 如果使用者以不正確使用者 PIN 碼輸入連續 10 次，則會觸發 DT2000 暴力攻擊機制，而且使用者 PIN 碼、加密金鑰連同**所有資料**都將會遭到刪除且永久失去。

已使用 PIN 碼來解鎖 DT2000	如果連續輸入 10 次不正確的 PIN 碼，會發生什麼情況？
使用者 PIN 碼	會觸發 DT2000 暴力攻擊機制，而且使用者 PIN 碼、加密金鑰和所有資料都將會遭到刪除且永久失去。

如果使用者以不正確使用者 PIN 碼輸入連續十 (10) 次，加密金鑰和所有資料都將會遭到刪除且永久失去。DT2000 之後會轉換回原廠預設的使用者 PIN 碼 (設定為 11223344) - 請閱第 6 頁第 4 節以瞭解如何變更使用者 PIN 碼。此外，因為這會強迫您建立新的加密金鑰，所以必須將 DT2000 重新格式化 (請參閱第 13 或 14 節)。

與其他類似裝置不同之處在於，DT2000 內建隨機數字產生器。一旦重設隨身碟，便會隨機產生新的加密金鑰。











## 12. 如何重設 DT2000

若是忘記使用者 PIN 碼，或是使用者希望刪除儲存在 DT2000 上的所有資料，請依照以下指示進行。

重設程序將會清除包含使用者 PIN 碼在內的所有密碼編譯參數。這代表 DT2000 會轉換回預設的使用者 PIN 碼 (設定為 11223344) - 請閱第 6 頁第 4 節以瞭解如何變更使用者 PIN 碼。此外，因為這會強迫您建立新的加密金鑰，所以必須將 DT2000 重新格式化 (請參閱第 13 或 14 節)。



**注意：**重設 DT2000 將會刪除儲存在隨身碟上的所有資料。

指示	LED 指示燈	LED 指示燈狀態
1. 按下並按住數字7 (pqrs) 按鈕，然後按下 KEY  按鈕。 放開按鈕 (7 &  )	 / 	紅色和綠色 LED 指示燈交互閃爍
2. 在 10 秒內，輸入數字 9 (wxyz) 按鈕三次 (連按三下) (999)	 / 	紅色和綠色 LED 指示燈持續交互閃爍
3. 按下並按住數字7 (pqrs) 按鈕，然後按下 KEY  按鈕。 放開按鈕 (7 &  )		紅色 LED 指示燈淡出以完成重設程序

## 13. 如何使用 Windows OS 設定 DT2000

如果連續輸入 10 次不正確的 PIN 碼，或是重設隨身碟，則會觸發駭客偵測，而且會永久失去隨身碟上的所有資料。

建立新的使用者 PIN 碼之後，必須對 DT2000 進行初始化和格式化。

若要初始化 DT2000，請依照以下指示：

1. 建立新的使用者 PIN 碼 (請參閱第 4 節)。
2. 輸入新的使用者 PIN 碼以解鎖 DT2000，然後將之連接到電腦的 USB 連接埠。
3. 電腦應該會通知使用者下列訊息：

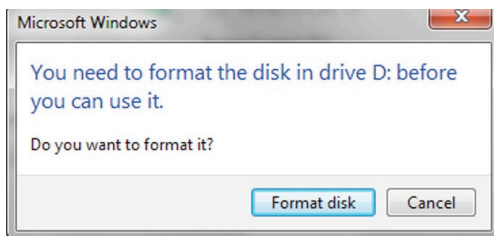

4. 按一下**格式化磁碟**以繼續。  
根據您的需求以選取 **FAT32** 或 **NTFS**，輸入磁碟區標籤並按一下**開始**。

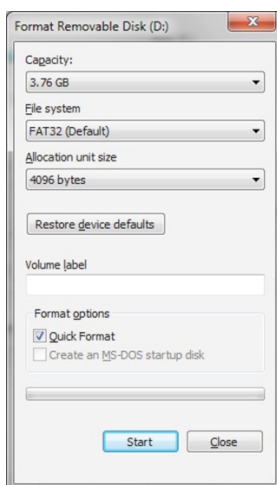

5. 按一下**確定**以繼續格式化隨身碟。

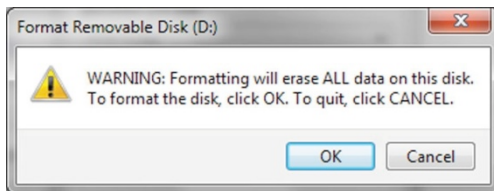

 **警告：**此程序將清除儲存在隨身碟上的所有資料。

6. 電腦會完成格式化隨身碟並確認格式化已完成。格式化 DT2000 時，**藍色** LED 指示燈會閃爍。

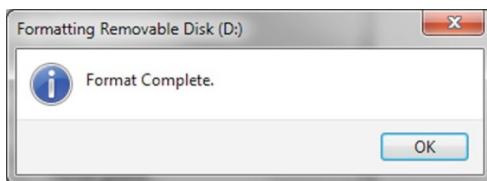

完成之後，**藍色** LED 指示燈便會恆亮，您的 DT2000 即隨時可用。

如果未出現格式化精靈，請依照以下程序：

1. 在**我的電腦**或**電腦**上按一下滑鼠右鍵，然後按一下**管理**。
2. 在**磁碟管理**索引標籤下方的**電腦管理**視窗中，DT2000 會被識別為屬於原始格式的可移除裝置。

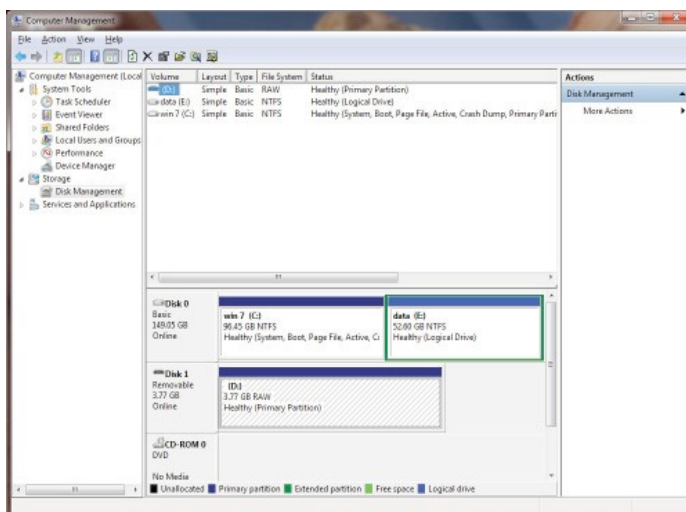

3. 在未配置區塊下方的空白區域，在可移除的原始磁碟機上按一下滑鼠右鍵，然後選取格式化。

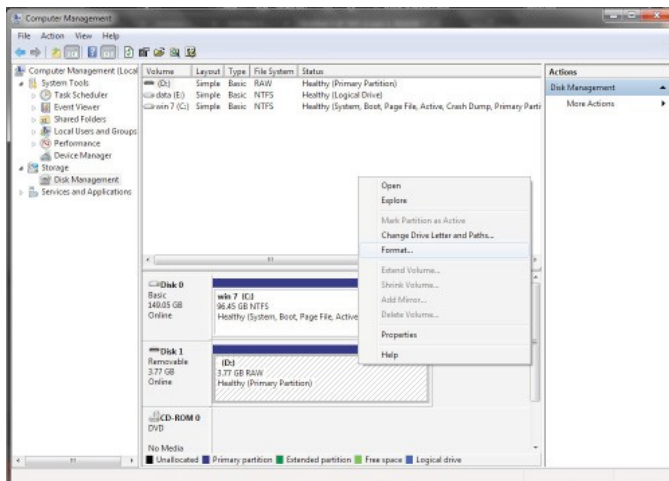

4. 格式化視窗隨即開啟。  
輸入新的磁碟區標籤。  
根據您的需求以選取 FAT32 或 NTFS，然後按一下確定。

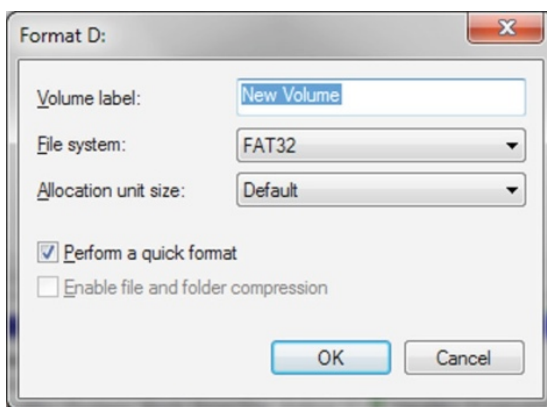

5. 按一下格式化警告視窗上的確定，以繼續格式化隨身碟。

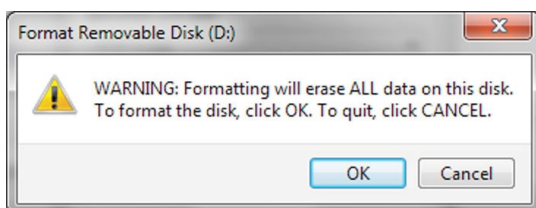

**警告：**此程序將清除儲存在隨身碟上的所有資料。

6. 電腦會完成格式化並返回磁碟管理視窗。

格式化 DT2000 時，藍色 LED 指示燈會開始閃爍。

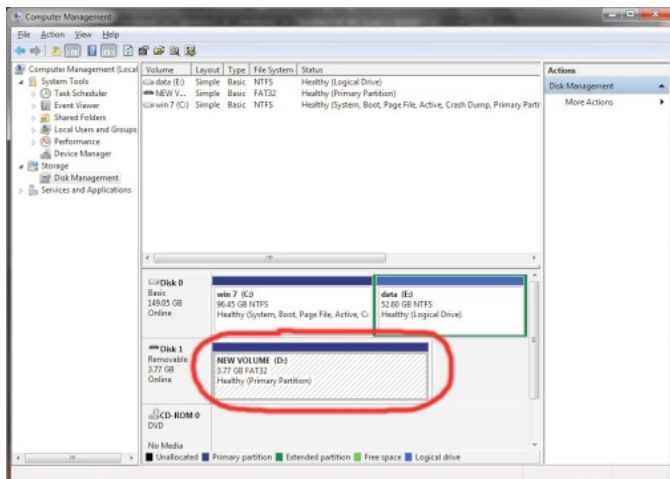

完成時，藍色 LED 指示燈便會恆亮，您的 DT2000 即隨時可用。

## 14. 如何使用 Mac OS 設定 DT2000

如果連續輸入 10 次不正確的 PIN 碼，或是重設隨身碟，則會觸發駭客偵測，而且會永久失去隨身碟上的所有資料。

建立新的使用者 PIN 碼之後，必須對 DT2000 進行初始化和格式化。

如果想在 Mac OS 電腦上格式化 DT2000，請依照下列方式進行：

1. 建立新的使用者 PIN 碼 (請參閱第 4 節)。
2. 輸入新的使用者 PIN 碼以解鎖 DT2000，然後將之連接到 Mac 電腦的 USB 連接埠。系統會出現初始化視窗來提示您。

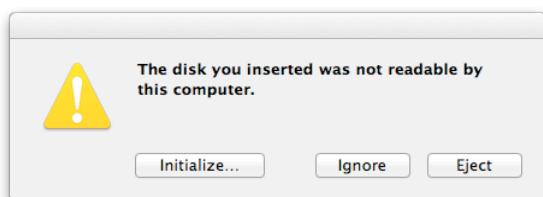

3. 按下初始化並在磁碟公用程式視窗中選取 DT2000。

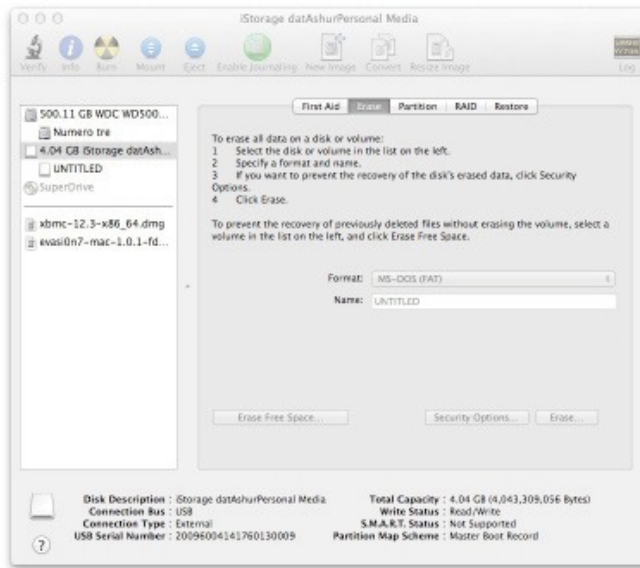

4. 按一下磁碟公用程式視窗左側的 DT2000。
5. 從視窗右側的內容功能表選擇清除。選取 **MS-DOS** 作為磁碟區格式。
6. 按一下清除。

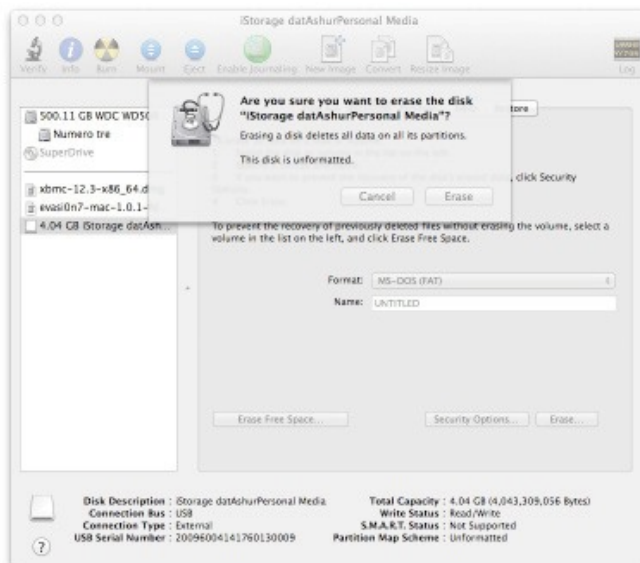

7. 完成格式化之後的 DT2000 將會顯示在磁碟公用程式視窗中，而且會釘選到桌面。

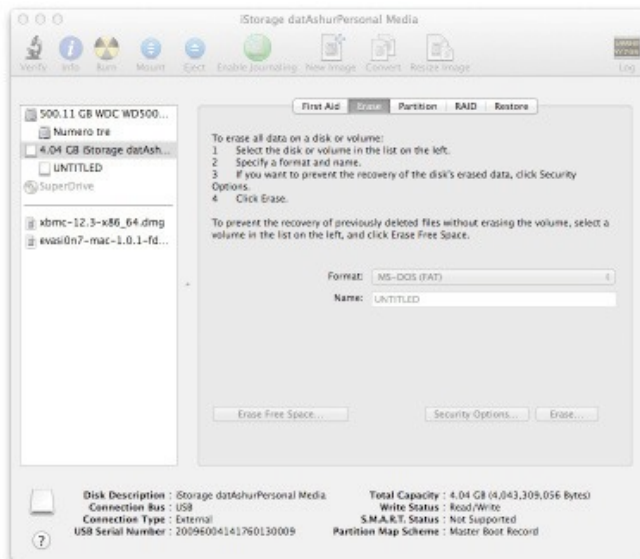

## 電池資訊/產品丟棄

請勿將電器或含有電池的電子廢棄物，與一般的家庭廢棄物一併丟棄。請務必以符合規範的方式丟棄電子產品，將環境衝擊降到最低。請勿自行取出產品中的電池，只可由 Kingston 或專業的供應商提供服務。如需詳細瞭解電池及如何以符合規範的方式回收產品，請與我們聯絡。

DataTraveler® 2000 整合了 ClevX, LLC 授權的 DataLock® 技術。