



# **NETGEAR ReadyNAS OS 6 Rack-Mount Storage Systems**

**Hardware Manual**

**Models:**

**ReadyNAS 2120**

**ReadyNAS 2120 v2**

**ReadyNAS 3130**

**ReadyNAS 3138**

**ReadyNAS 3220**

**ReadyNAS 4220**

October 2015  
202-11272-06

350 East Plumeria Drive  
San Jose, CA 95134  
USA



### Support

Thank you for purchasing this NETGEAR product. You can visit [www.netgear.com/support](http://www.netgear.com/support) to register your product, get help, access the latest downloads and user manuals, and join our community. We recommend that you use only official NETGEAR support resources.

### Conformity

For the current EU Declaration of Conformity, visit [http://kb.netgear.com/app/answers/detail/a\\_id/11621](http://kb.netgear.com/app/answers/detail/a_id/11621).

### Compliance

For regulatory compliance information, visit <http://www.netgear.com/about/regulatory>.

See the regulatory compliance document before connecting the power supply.

### Trademarks

© NETGEAR, Inc., NETGEAR and the NETGEAR Logo are trademarks of NETGEAR, Inc. Any non-NETGEAR trademarks are used for reference purposes only.

# Contents

## Chapter 1 Getting Started

Additional Documentation .....	6
Setup Location .....	6
Supported Operating Systems .....	7
Supported Browsers .....	7
Diskless Storage System .....	7

## Chapter 2 ReadyNAS 2120 and 2120 v2

Front Panel .....	9
Rear Panel .....	10
Status Information .....	11
Power On and Shut Down .....	12
Power On .....	12
Preferred Shutdown .....	12
Forced Shutdown .....	12
Power State .....	13
Boot Menu .....	13
Rack Mounting .....	15

## Chapter 3 ReadyNAS 3130

Front Panel .....	18
Rear Panel .....	20
Status Information .....	21
Power On and Shut Down .....	23
Power On .....	23
Preferred Shutdown .....	23
Forced Shutdown .....	23
Power State .....	24
Boot Menu .....	24
Rack Mounting .....	26

## Chapter 4 ReadyNAS 3138

Front Panel .....	28
Rear Panel .....	30
Status Information .....	31
Power On and Shut Down .....	33
Power On .....	33
Preferred Shutdown .....	33

Forced Shutdown .....	33
Power State .....	34
Boot Menu .....	34
Rack Mounting .....	36

## Chapter 5 ReadyNAS 3220 and 4220

Front Panel .....	38
ReadyNAS 3220 Rear Panel .....	40
ReadyNAS 4220 Rear Panel .....	41
Status Information .....	42
Boot Menu .....	43
Rack-Mount Setup .....	45
Installation .....	45

## Chapter 6 Disks

Disk Tray .....	48
Supported Disks .....	49
Previously Formatted Disks .....	49
Reformat Previously Formatted Disks .....	49
Migrate a Volume .....	50
Add a Disk .....	51
Replace a Disk .....	56

## Chapter 7 Maintenance

Access the Inside of the Storage System .....	62
Replace a Fan .....	64
Replace the On-Board Battery .....	67

## Appendix A Defaults and Technical Specifications

Factory Default Settings .....	70
ReadyNAS 2120 and 2120 v2 Technical Specifications .....	70
ReadyNAS 3130 Technical Specifications .....	72
ReadyNAS 3138 Technical Specifications .....	73
ReadyNAS 3220 Technical Specifications .....	74
ReadyNAS 4220 Technical Specifications .....	75
Safety Warnings .....	76
Electrical Safety Precautions .....	76
General Safety Precautions .....	77
Electrostatic Discharge Precautions .....	78
Rack-Mount Precautions .....	78

# Getting Started

---

# 1

Congratulations on your purchase of a NETGEAR ReadyNAS® storage system. This manual describes the physical features of the ReadyNAS OS 6 rack-mount storage systems.

This chapter contains the following sections:

- *Additional Documentation*
- *Setup Location*
- *Supported Operating Systems*
- *Supported Browsers*
- *Diskless Storage System*

---

**Note:** For more information about the topics that are covered in this manual, visit the support website at <http://support.netgear.com/product/ReadyNAS-OS6>.

---

## Additional Documentation

For detailed information about configuring, managing, and using your ReadyNAS storage system, see the *ReadyNAS OS 6.4 Software Manual*, which is available at

<http://support.netgear.com/product/ReadyNAS-OS6>.

For additional product support information, visit

<http://support.netgear.com/product/ReadyNAS-OS6>.

## Setup Location

Your ReadyNAS storage system is intended for installation in a restricted access location (dedicated equipment rooms, service closets, and the like) only.

Keep the following considerations in mind as you install your system:

- **Ambient operating temperature.** If the system is installed in a closed or multiunit rack assembly, the ambient operating temperature of the rack environment might be greater than the ambient temperature of the room. Therefore, consider installing the equipment in an environment compatible with the maximum rated ambient temperature. See [Appendix A, Defaults and Technical Specifications](#).
- **Reduced airflow.** Mount the equipment into a rack so that the amount of airflow required for safe operation is not compromised.
- **Mechanical loading.** Mount the equipment into a rack so that a hazardous condition does not arise due to uneven mechanical loading.
- **Circuit overloading.** Consider the equipment's connection to the power supply circuitry and the effect that any possible overloading of circuits might create on overcurrent protection and power supply wiring. Consider equipment nameplate ratings when addressing this concern.
- **Reliable grounding.** This product requires reliable grounding to be maintained at all times. To ensure this, ground the rack itself. Pay particular attention to power supply connections other than the direct connections to the branch circuit (for example, the use of power strips).
- **Clearance.** Leave enough clearance in front of the rack (about 25 inches) to enable you to open the front door completely and in the back of the rack (about 30 inches) to allow for sufficient airflow and ease in servicing.

## Supported Operating Systems

The ReadyNAS storage system is supported on the following systems:

- Microsoft Windows 10 (16 and 32 bit)
- Microsoft Windows 8.1 (16 and 32 bit)
- Microsoft Windows 8 (16 and 32 bit)
- Microsoft Windows 7 (16 and 32 bit)
- Microsoft Server 2012 (64 bit)
- Microsoft Server 2008 R2 (64 bit)
- Apple OS X 10.7 or later
- Linux, UNIX, Solaris
- Apple iOS
- Google Android

## Supported Browsers

The ReadyNAS local admin page supports the following browsers:

- Microsoft Edge
- Microsoft Internet Explorer 9.0 and later
- Apple Safari, 5.0 and later
- Google Chrome 20 and later
- Mozilla Firefox 14 and later

If you experience difficulty accessing the local admin page or if you notice unexpected behavior, try using another browser. For more information about the ReadyNAS local admin page, see the *ReadyNAS OS 6.4 Software Manual*, which is available at <http://support.netgear.com/product/ReadyNAS-OS6>.

## Diskless Storage System

If you purchased a ReadyNAS storage system without a preinstalled disk drive or drives, you must add at least one disk to your system before you use the system. You can add a 3.5-inch hard disk drive, a 2.5-inch hard disk drive, or a 2.5-inch solid-state drive to an empty disk bay. For information about how to install a disk, see [Add a Disk](#) on page 51.

Use only supported SATA hard disk drives (HDDs) or solid-state drives (SSDs) in your ReadyNAS storage system. If you use disks that are not supported, NETGEAR technical support will not provide assistance. For a list of supported disks, see the NETGEAR Hardware Compatibility List at <http://www.netgear.com/readynas-hcl>.

If you are adding a previously formatted disk to your storage system, see the instructions in [Previously Formatted Disks](#) on page 49.

## 2 ReadyNAS 2120 and 2120 v2

---

# 2

This chapter describes the physical features of the ReadyNAS 2120 and the 2120 v2 storage systems. It includes the following sections:

- *Front Panel*
- *Rear Panel*
- *Status Information*
- *Power On and Shut Down*
- *Boot Menu*
- *Rack Mounting*



## Front Panel

The following figure shows the front panel of the ReadyNAS 2120 and 2120 v2 storage systems.

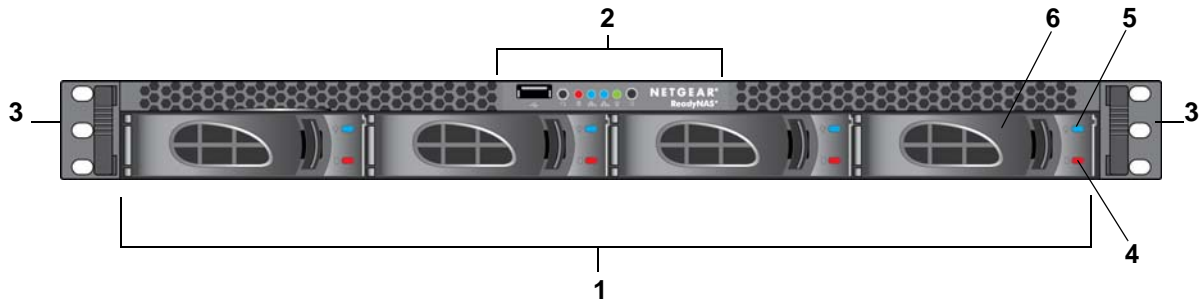

**Figure 1. Front panel**

1. Drive bays
2. Control panel
3. Mounting bracket
4. Fault LED
5. Disk Activity LED
6. Disk tray (For more information, see [Disk Tray](#) on page 48.)

The following figure shows the control panel in more detail.

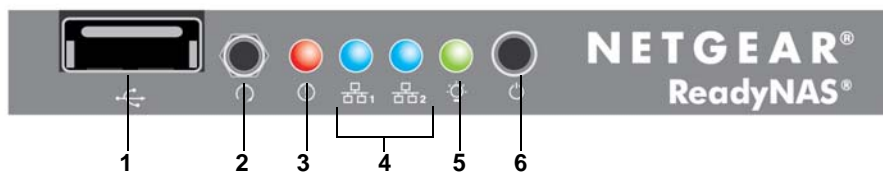
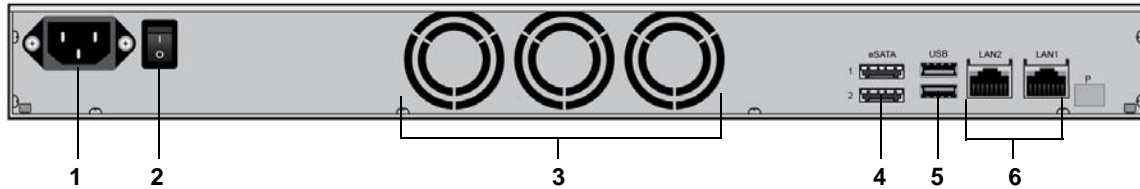

**Figure 2. Control panel**

1. USB 2.0 port
2. Reset button
3. Error LED
4. LAN 1 and LAN 2 LEDs
5. Power LED
6. Power button

## Rear Panel

The following figure shows the rear panel of the ReadyNAS 2120 and the 2120 v2 storage systems.



**Figure 3. Rear panel**

1. Power cable socket
2. Power switch
3. Disk exhaust fans
4. eSATA ports
5. USB 3.0 ports
6. LAN ports with LED status indicators

## Status Information

You can obtain information about the status of your ReadyNAS 2120 or 2120 v2 storage system by reviewing the LEDs listed in the following table.

**Table 1. Status information**

Indicator	Description
Disk Activity LED (disk tray, top)	The Disk Activity LEDs indicate these states: <ul style="list-style-type: none"> <li>• <b>Solid blue.</b> A disk is present.</li> <li>• <b>Blinking.</b> The disk is active.</li> <li>• <b>Off.</b> No disk is present.</li> </ul>
Fault LED (disk tray, bottom)	The Fault LEDs indicate these states: <ul style="list-style-type: none"> <li>• <b>Solid red.</b> The disk was removed, failed, or is resynchronizing.</li> <li>• <b>Off.</b> No disk is active.</li> </ul>
Error LED (front panel)	The Error LED indicates these states: <ul style="list-style-type: none"> <li>• <b>Solid red.</b> The system needs attention. Use the local admin page to determine the problem. For more information, see the <i>ReadyNAS OS 6.4 Software Manual</i>, which is available at <a href="http://support.netgear.com/product/ReadyNAS-OS6">http://support.netgear.com/product/ReadyNAS-OS6</a>.</li> <li>• <b>Off.</b> The system is healthy.</li> </ul>
LAN 1 and LAN 2 LEDs (front panel)	The LAN LEDs indicate these states: <ul style="list-style-type: none"> <li>• <b>Solid blue.</b> An Ethernet cable is connected.</li> <li>• <b>Blinking.</b> The Ethernet link is active.</li> <li>• <b>Off.</b> There is no Ethernet connection.</li> </ul>
LAN port LEDs (rear panel)	Two LED status indicators are built into each LAN port. One LED is green and one is amber. They indicate port speed and activity as follows: <ul style="list-style-type: none"> <li>• <b>Green on, amber off.</b> 1000 Mbps connection speed, no activity.</li> <li>• <b>Green blinking, amber off.</b> 1000 Mbps connection speed, activity.</li> <li>• <b>Green off, amber on.</b> 10 Mbps or 100 Mbps connection speed, no activity.</li> <li>• <b>Green off, amber blinking.</b> 10 Mbps or 100 Mbps connection speed, activity.</li> <li>• <b>Green off, amber off.</b> No connection.</li> </ul>
Power LED (front panel)	The Power LED indicates these states: <ul style="list-style-type: none"> <li>• <b>Solid green.</b> The system is powered on.</li> <li>• <b>Blinking.</b> The system is powering on or powering off.</li> <li>• <b>Off.</b> Power is not supplied to the system.</li> </ul>

## Power On and Shut Down

This section describes how to power on and shut down your system. If you must shut down the system, use one of the preferred shutdown methods whenever possible.

### Power On

➤ **To power on the system:**

1. Connect the system to a power supply.
2. Move the **Power** switch to the On position.

The **Power** switch is located on the back panel of the system.

**Note:** Depending on the system's last power state, the system might power on automatically. For more information, see *Power State* on page 13.

3. If necessary, press the **Power** button on the front panel of the system.  
The system powers on.

### Preferred Shutdown

You can gracefully shut down your system by using the **Power** button or the ReadyNAS local admin page.

For information about how to gracefully shut down your system using the ReadyNAS local admin page, see the *ReadyNAS OS 6.4 Software Manual*, which is available at <http://support.netgear.com/product/ReadyNAS-OS6>.

➤ **To gracefully shut down your system using the Power button:**

1. Press the **Power** button on the front panel of the system.  
The Power LED blinks, prompting you to confirm the shutdown.
2. Press the **Power** button again.  
The system shuts down gracefully.

### Forced Shutdown

Perform a forced shutdown only if the storage system is not responding.

➤ **To perform a forced shutdown:**

Flip the **Power** switch to the Off position.

The **Power** switch is located on the back panel of the system.

The system shuts down.

## Power State

If the power supply is interrupted due to a power failure, the system returns to its last state once the power supply is restored, as follows:

- If the system was powered on at the time of the power failure, the system powers on when the power supply is restored.
- If the system was powered off at the time of the power failure, the system remains off when the power supply is restored.

## Boot Menu

Use the boot menu to restart or troubleshoot your ReadyNAS storage system. Your storage system provides the following boot modes:

- **Normal.** Initiates a normal boot process, just like booting using the **Power** button.
- **Factory default.** Initiates a short disk test that takes approximately 5 minutes. After the disk test, a 10-minute time-out period begins. During the 10-minute time-out period, you can choose to power off the storage system without causing any data loss, and the factory default process is canceled. If you choose not to power off the storage system, after the 10-minute time-out period, the factory default process begins.



### WARNING:

**The factory default reboot process resets the storage system to factory settings, erases all data, resets all defaults, and reformats the disk to X-RAID.**

---

**Note:** To start the factory default process immediately, press the **Reset** button during the 10-minute time-out period.

---

- **OS reinstall.** Reinstalls the firmware from the internal flash to the disks. Use the OS reinstall boot mode when the system crashes and corrupts some configuration files. OS reinstall boot mode also resets some settings on your storage system, such as Internet protocol settings and the administrator password, to defaults.
- **Tech support.** Boots into a low-level diagnostic mode. Use the tech support boot mode only when a NETGEAR technical support representative instructs you to do so.
- **Volume read only.** Mounts a volume as read-only. Use this option when you are attempting to rescue data off a disk during a disaster recovery.
- **Memory test.** Performs a memory test. The pass or fail result is reported using the storage system's LEDs. Contact a NETGEAR technical support representative to interpret memory test results.

- **Test disk.** Performs an offline full disk test. This process can take four hours or more, depending on the size of your disks. Any problems are reported in the system logs, which you can view using the local admin page. For more information about viewing the system logs, see the *ReadyNAS OS 6.4 Software Manual*.

➤ **To access the boot menu:**

1. Power off your system.
2. Using a straightened paper clip, press and hold the **Reset** button.
3. Press the **Power** button on the front panel of the system.

The system powers on.

4. Continue to press the **Reset** button for about five seconds until the Power LED is solid green and the Error LED, LAN 1 LED, and LAN 2 LED are blinking.
5. Press and release the **Reset** button to scroll through the boot mode menu.

Each press and release scrolls forward to the next item in the boot mode menu.

The storage system shows the boot mode options using the LEDs, as described in the following table:

Boot Mode	Status Indicator				
	Description	Error LED	LAN 1 LED	LAN 2 LED	Power LED
Boot menu	Error LED and both LAN LEDs blink. Power LED lights.	* (red)	* (cyan)	* (cyan)	● (green)
Normal	LAN 2 and Power LEDs light.	● (grey)	● (grey)	● (cyan)	● (green)
Factory default	LAN 1 and Power LEDs light.	● (grey)	● (cyan)	● (grey)	● (green)
OS reinstall	Both LAN LEDs and the Power LED light.	● (grey)	● (cyan)	● (cyan)	● (green)
Tech support	Error and Power LEDs light.	● (red)	● (grey)	● (grey)	● (green)
Volume read only	Error, LAN 2, and Power LEDs light.	● (red)	● (grey)	● (cyan)	● (green)
Memory test	Error, LAN 1, and Power LEDs light.	● (red)	● (cyan)	● (grey)	● (green)
Test disk	All four LEDs light.	● (red)	● (cyan)	● (cyan)	● (green)

Legend:

- Solid: ● (red) ● (cyan) ● (green)
- Blinking: \* (red) \* (cyan) \* (green)
- Off: ● (grey)

6. Press and hold the **Reset** button for five seconds to confirm your boot menu selection.

The system boots in the selected boot mode.

## Rack Mounting

You can rack-mount the ReadyNAS 2120 and 2120 v2 storage systems using the included rack-mount ears.

Alternatively, you can use the optional sliding rail kit, order number RRAIL04-10000S. For instructions, see the *1U Rail Installation Guide*, which is available at <http://support.netgear.com/product/ReadyNAS-OS6>.





# ReadyNAS 3130

---

# 1

This chapter describes the physical features of the ReadyNAS 3130 storage system. It includes the following sections:

- *Front Panel*
- *Rear Panel*
- *Status Information*
- *Power On and Shut Down*
- *Boot Menu*
- *Rack Mounting*

## Front Panel

The following figure shows the front panel of the ReadyNAS 3130 storage system.

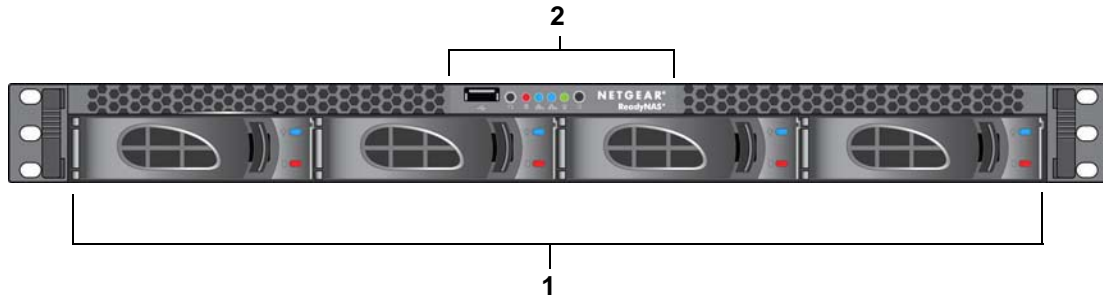

**Figure 4. Front panel**

1. Drive bays with disk status LEDs
2. Control panel

The following figure shows the control panel in more detail.

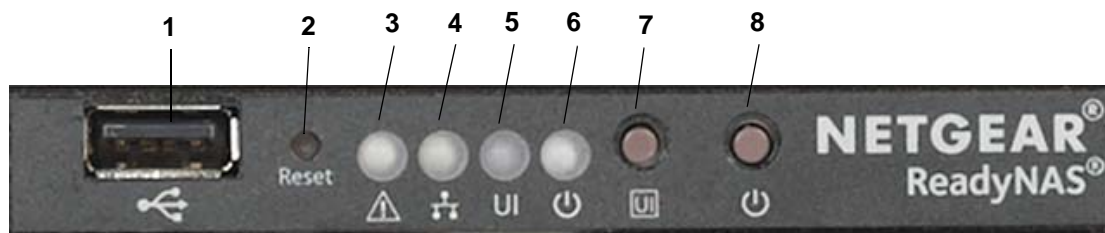

- |                 |                                 |
|-----------------|---------------------------------|
| 1. USB 2.0 port | 5. Unit Identifier (UID) LED    |
| 2. Reset button | 6. Power LED                    |
| 3. Health LED   | 7. Unit Identifier (UID) button |
| 4. LAN LED      | 8. Power button                 |

**Figure 5. Control panel**

Each drive bay features a latch that releases the pop-out tray handle, as shown in the following figure.



**Figure 6. Drive bay**

1. Disk tray handle
2. Disk Present LED
3. Disk tray release latch
4. Disk Activity or Fault LED



**WARNING:**

No matter how many hard drives are installed in your system, ensure that all drive trays remain in the drive bays to maintain proper airflow.

## Rear Panel

The following figure shows the rear panel of the ReadyNAS 3130 storage system.

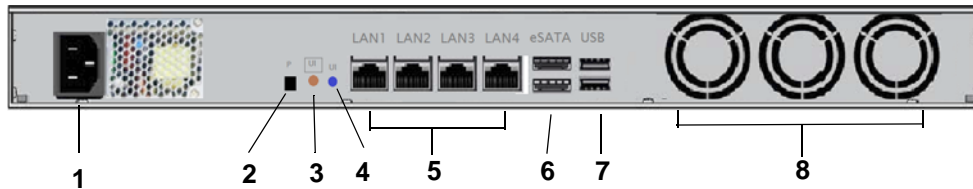

**Figure 7. Rear panel**

1. Power cable socket
2. Reserved for NETGEAR support
3. Unit Identifier (UID) button
4. Unit Identifier (UID) LED
5. Four 1-gigabit LAN ports with LED status indicators
6. Two eSATA ports
7. Two USB 3.0 ports
8. Three disk exhaust fans

## Status Information

You can obtain information about the status of your system by reviewing the indicators listed in the following table.

**Table 2. Status indicators**

Indicator	Description
Power LED (control panel)	<p>The Power LED indicates these states:</p> <ul style="list-style-type: none"> <li>• <b>Green.</b> The system is powered on.</li> <li>• <b>Blinking.</b> The system is powering on or powering off.</li> <li>• <b>Off.</b> Power is not supplied to the system.</li> </ul>
UI LED (control panel)	<p>The UI (Unit Identifier) LED indicates these states:</p> <ul style="list-style-type: none"> <li>• <b>Blue.</b> Software or manual identification is on.</li> <li>• <b>Off.</b> Identification is not requested by software or manually when the <b>UI</b> button is pressed.</li> </ul> <p>Pressing the <b>UI</b> button on either the control panel or the rear panel toggles the UI LEDs on the control panel and the rear panel. Use this in a situation such as a densely populated rack when you are working from both the front and back of the server.</p>
Health LED (control panel)	<p>The Health LED indicates these states:</p> <ul style="list-style-type: none"> <li>• <b>Red.</b> The system needs attention. Use the local admin page to determine the problem. For more information, see the <i>ReadyNAS OS 6.4 Software Manual</i>, which is available at <a href="http://support.netgear.com/product/ReadyNAS-OS6">http://support.netgear.com/product/ReadyNAS-OS6</a>.</li> <li>• <b>Off.</b> The system is healthy.</li> </ul>
LAN LED (control panel)	<p>The LAN LED indicates these states:</p> <ul style="list-style-type: none"> <li>• <b>Blue.</b> One or more Ethernet ports are linked.</li> <li>• <b>Blinking.</b> One or more Ethernet ports are active.</li> <li>• <b>Off.</b> There is no Ethernet connection.</li> </ul>
Disk LEDs (disk trays)	<p>The top LED indicates disk status, as follows:</p> <ul style="list-style-type: none"> <li>• <b>Green.</b> A disk is present and in use.</li> <li>• <b>Off.</b> No disk is present, or is not in use.</li> </ul> <p>The bottom LED indicates disk activity as follows:</p> <ul style="list-style-type: none"> <li>• <b>Blinking green.</b> The disk is being accessed.</li> <li>• <b>Off.</b> The disk is idling.</li> <li>• <b>Red.</b> The disk was removed, failed, or is resynchronizing.</li> </ul>

Table 2. Status indicators (continued)

Indicator (continued)	Description
UI LED (rear panel)	<p>The UI (Unit Identifier) LED indicates these states:</p> <ul style="list-style-type: none"> <li>• <b>Blue.</b> Software or manual identification is on.</li> <li>• <b>Off.</b> Identification is not requested by software or manually when the <b>UI</b> button is pressed.</li> </ul> <p>Pressing the <b>UI</b> button on either the control panel or the rear panel toggles the UI LEDs on the control panel and the rear panel. Use this in a situation such as a densely populated rack when you are working from both the front and back of the server.</p>
LAN port LEDs (rear panel)	<p>Two LED status indicators are built into each LAN port. One LED is green and one is amber. They indicate port speed and activity as follows:</p> <ul style="list-style-type: none"> <li>• <b>Green on, amber off.</b> 1000 Mbps connection speed, no activity.</li> <li>• <b>Green blinking, amber off.</b> 1000 Mbps connection speed, activity.</li> <li>• <b>Green off, amber on.</b> 10 Mbps or 100 Mbps connection speed, no activity.</li> <li>• <b>Green off, amber blinking.</b> 10 Mbps or 100 Mbps connection speed, activity.</li> <li>• <b>Green off, amber off.</b> No connection.</li> </ul>

## Power On and Shut Down

This section describes how to power on and shut down your system. If you must shut down the system, use one of the preferred shutdown methods whenever possible.

### Power On

➤ **To power on the system:**

1. Connect the system to a power supply.

**Note:** Depending on the system's last power state, the system might power on automatically. For more information, see *Power State* on page 24.

2. If necessary, press the **Power** button on the front panel of the system.

The system powers on.

### Preferred Shutdown

You can gracefully shut down your system by using the **Power** button or the ReadyNAS local admin page.

For information about how to gracefully shut down your system using the ReadyNAS local admin page, see the *ReadyNAS OS 6.4 Software Manual*, which is available at <http://support.netgear.com/product/ReadyNAS-OS6>.

➤ **To gracefully shut down your system using the Power button:**

1. Press the **Power** button on the front panel of the system.

The Power LED blinks, prompting you to confirm the shutdown.

2. Press the **Power** button again.

The system shuts down gracefully.

### Forced Shutdown

Perform a forced shutdown only if the storage system is not responding.

➤ **To perform a forced shutdown:**

Press and hold the **Power** button on the front panel for more than four seconds.

The system shuts down.

## Power State

If the power supply is interrupted due to a power failure, the system returns to its last state once the power supply is restored, as follows:

- If the system was powered on at the time of the power failure, the system powers on when the power supply is restored.
- If the system was powered off at the time of the power failure, the system remains off when the power supply is restored.

## Boot Menu

Use the boot menu to restart or troubleshoot your ReadyNAS storage system. Your storage system provides the following boot modes:

- **Normal.** Initiates a normal boot process, just like booting using the **Power** button.
- **Factory default.** Initiates a short disk test that takes approximately 5 minutes. After the disk test, a 10-minute time-out period begins. During the 10-minute time-out period, you can choose to power off the storage system without causing any data loss, and the factory default process is canceled. If you choose not to power off the storage system, after the 10-minute time-out period, the factory default process begins.



### **WARNING:**

**The factory default reboot process resets the storage system to factory settings, erases all data, resets all defaults, and reformats the disk to X-RAID.**

---

**Note:** To start the factory default process immediately, press the **Reset** button during the 10-minute time-out period.

---

- **OS reinstall.** Reinstalls the firmware from the internal flash to the disks. Use the OS reinstall boot mode when the system crashes and corrupts some configuration files. OS reinstall boot mode also resets some settings on your storage system, such as Internet protocol settings and the administrator password, to defaults.
- **Tech support.** Boots into a low-level diagnostic mode. Use the tech support boot mode only when a NETGEAR technical support representative instructs you to do so.
- **Volume read only.** Mounts a volume as read-only. Use this option when you are attempting to rescue data off a disk during a disaster recovery.
- **Memory test.** Performs a memory test. The pass or fail result is reported using the storage system's LEDs. During the test the Health LED and the UI LED light alternately. If a memory error is found, the Health LED and UI LED blink at the same time.



- **Test disk.** Performs an offline full disk test. This process can take four hours or more, depending on the size of your disks. Any problems are reported in the system logs, which you can view using the local admin page. For more information about viewing the system logs, see the *ReadyNAS OS 6.4 Software Manual*, which is available at <http://support.netgear.com/product/ReadyNAS-OS6>.

























➤ **To access the boot menu:**

1. Power off your system.
2. Using a straightened paper clip, press and hold the **Reset** button on the control panel.
3. Press and continue pressing the **Power** button on the front panel of the system until the system powers on and either the Power LED stops blinking or the Power, UI, and Health LEDs are lit.

**Note:** It takes approximately one minute for the system to enter boot mode.

4. Press and hold the **Reset** button, releasing after about one second, to scroll through the boot menu modes.

The storage system shows the boot mode options using the LEDs, as described in the following table:

Boot Mode	Status Indicator			
	Description	Health LED	UI LED	Power LED
Boot menu	Power, UI, and Health LEDs blink.			
Normal	Health LED lights.			
Factory default	UI LED lights.			
OS reinstall	UI and Health LEDs light.			
Tech support	Power LED lights.			
Volume read only	Power and Health LEDs light.			
Memory test	Power and UI LEDs light.			
Test disk	Power, UI, and Health LEDs light.			

Legend:

- Solid:   
- Blinking:   
- Off: 

5. Press and hold the **Reset** button for four seconds to confirm your boot menu selection.  
The system boots in the selected boot mode.

**Note:** If you do not hold the **Reset** button long enough, the press moves the system to the next selection. Repeat the press and hold for one second to scroll through to your desired selection.

## Rack Mounting

You can rack-mount the ReadyNAS 3130 using the included rack-mount ears.

Alternatively, you can use the optional sliding rail kit, order number RRAIL04-10000S. For instructions, see the *1U Rail Installation Guide*, which is available at <http://support.netgear.com/product/ReadyNAS-OS6>.

## 2 ReadyNAS 3138

---

# 2

This chapter describes the physical features of the ReadyNAS 3138 storage system. It includes the following sections:

- *Front Panel*
- *Rear Panel*
- *Status Information*
- *Power On and Shut Down*
- *Boot Menu*
- *Rack Mounting*

## Front Panel

The following figure shows the front panel of the ReadyNAS 3138.

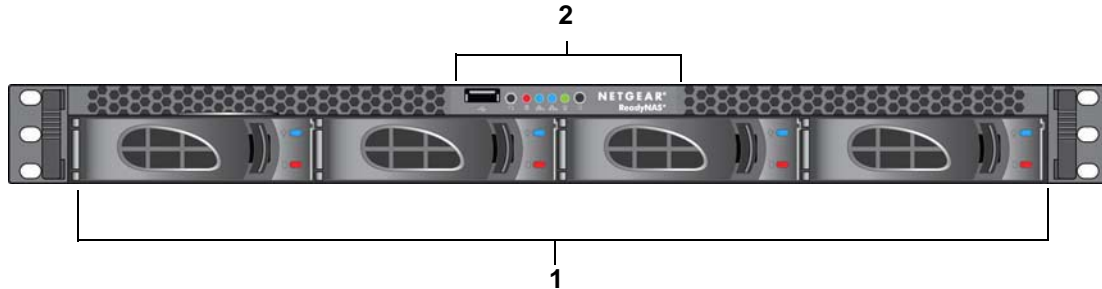

**Figure 8. Front panel**

1. Drive bays with disk status LEDs
2. Control panel

The following figure shows the control panel in more detail.



- |                 |                                 |
|-----------------|---------------------------------|
| 1. USB 2.0 port | 5. Unit identifier (UID) LED    |
| 2. Reset button | 6. Power LED                    |
| 3. Health LED   | 7. Unit identifier (UID) button |
| 4. LAN LED      | 8. Power button                 |

**Figure 9. Control panel**

Each drive bay features a latch that releases the pop-out tray handle, as shown in the following figure.



**Figure 10. Drive bay**

1. Disk tray handle
2. Disk Present LED
3. Disk tray release latch
4. Disk Activity or Fault LED



**WARNING:**

No matter how many hard drives are installed in your system, ensure that all drive trays remain in the drive bays to maintain proper airflow.

## Rear Panel

The following figure shows the rear panel of the ReadyNAS 3138 storage system.

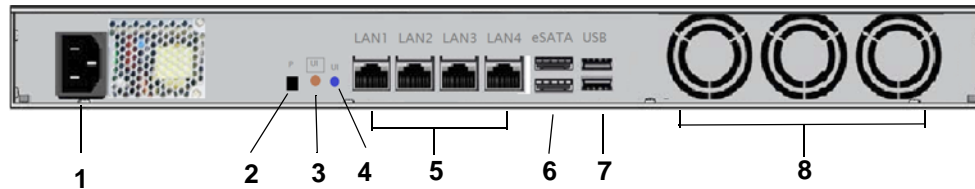

**Figure 11. Rear panel**

1. Power cable socket
2. Reserved for NETGEAR support
3. Unit Identifier (UID) button
4. Unit Identifier (UID) LED
5. Four 1-gigabit LAN ports with LED status indicators
6. Two eSATA ports
7. Two USB 3.0 ports
8. Three disk exhaust fans

## Status Information

You can obtain information about the status of your system by reviewing the indicators listed in the following table.

**Table 3. Status indicators**

Indicator	Description
Power LED (control panel)	<p>The Power LED indicates these states:</p> <ul style="list-style-type: none"> <li>• <b>Green.</b> The system is powered on.</li> <li>• <b>Blinking.</b> The system is powering on or powering off.</li> <li>• <b>Off.</b> Power is not supplied to the system.</li> </ul>
UI LED (control panel)	<p>The UI (Unit Identification) LED indicates these states:</p> <ul style="list-style-type: none"> <li>• <b>Blue.</b> Software or manual identification is on.</li> <li>• <b>Off.</b> Identification is not requested by software or manually when the <b>UI</b> button is pressed.</li> </ul> <p>Pressing the <b>UI</b> button on either the control panel or the rear panel toggles the UI LEDs on the control panel and the rear panel. Use this in a situation such as a densely populated rack when you are working from both the front and back of the server.</p>
Health LED (control panel)	<p>The Health LED indicates these states:</p> <ul style="list-style-type: none"> <li>• <b>Red.</b> The system needs attention. Use the local admin page to determine the problem. For more information, see the <i>ReadyNAS OS 6.4 Software Manual</i>, which is available at <a href="http://support.netgear.com/product/ReadyNAS-OS6">http://support.netgear.com/product/ReadyNAS-OS6</a>.</li> <li>• <b>Off.</b> The system is healthy.</li> </ul>
LAN LED (control panel)	<p>The LAN LED indicates these states:</p> <ul style="list-style-type: none"> <li>• <b>Blue.</b> One or more Ethernet ports are linked.</li> <li>• <b>Blinking.</b> One or more Ethernet ports are active.</li> <li>• <b>Off.</b> There is no Ethernet connection.</li> </ul>
Disk LEDs (disk trays)	<p>The top LED indicates disk status, as follows:</p> <ul style="list-style-type: none"> <li>• <b>Green.</b> A disk is present and in use.</li> <li>• <b>Off.</b> No disk is present, or not in use.</li> </ul> <p>The bottom LED indicates disk activity as follows:</p> <ul style="list-style-type: none"> <li>• <b>Blinking green.</b> The disk is being accessed.</li> <li>• <b>Off.</b> The disk is idling.</li> <li>• <b>Red.</b> The disk was removed, failed, or is resynchronizing.</li> </ul>

Table 3. Status indicators (continued)

Indicator	Description
UI LED (rear panel)	<p>The UI (Unit Identifier) LED indicates these states:</p> <ul style="list-style-type: none"> <li>• <b>Blue.</b> Software or manual identification is on.</li> <li>• <b>Off.</b> Identification is not requested by software or manually when the <b>UI</b> button is pressed.</li> </ul> <p>Pressing the <b>UI</b> button on either the control panel or the rear panel toggles the UI LEDs on the control panel and the rear panel. Use this in a situation such as a densely populated rack when you are working from both the front and back of the server.</p>
LAN port LEDs (rear panel)	<p>Two LED status indicators are built into each LAN port. One LED is green and one is amber. They indicate port speed and activity as follows:</p> <ul style="list-style-type: none"> <li>• <b>Green on, amber off.</b> 1000 Mbps connection speed, no activity.</li> <li>• <b>Green blinking, amber off.</b> 1000 Mbps connection speed, activity.</li> <li>• <b>Green off, amber on.</b> 10 Mbps or 100 Mbps connection speed, no activity.</li> <li>• <b>Green off, amber blinking.</b> 10 Mbps or 100 Mbps connection speed, activity.</li> <li>• <b>Green off, amber off.</b> No connection.</li> </ul>



## Power On and Shut Down

This section describes how to power on and shut down your system. If you must shut down the system, use one of the preferred shutdown methods whenever possible.

### Power On

➤ **To power on the system:**

1. Connect the system to a power supply.

**Note:** Depending on the system's last power state, the system might power on automatically. For more information, see *Power State* on page 34.

2. If necessary, press the **Power** button on the front panel of the system.

The system powers on.

### Preferred Shutdown

You can gracefully shut down your system by using the **Power** button or the ReadyNAS local admin page.

For information about how to gracefully shut down your system using the ReadyNAS local admin page, see the *ReadyNAS OS 6.4 Software Manual*, which is available at <http://support.netgear.com/product/ReadyNAS-OS6>.

➤ **To gracefully shut down your system using the Power button:**

1. Press the **Power** button on the front panel of the system.

The Power LED blinks, prompting you to confirm the shutdown.

2. Press the **Power** button again.

The system shuts down gracefully.

### Forced Shutdown

Perform a forced shutdown only if the storage system is not responding.

➤ **To perform a forced shutdown:**

Press and hold the **Power** button on the front panel for more than four seconds.

The system shuts down.

## Power State

If the power supply is interrupted due to a power failure, the system returns to its last state once the power supply is restored, as follows:

- If the system was powered on at the time of the power failure, the system powers on when the power supply is restored.
- If the system was powered off at the time of the power failure, the system remains off when the power supply is restored.

## Boot Menu

Use the boot menu to restart or troubleshoot your ReadyNAS storage system. Your storage system provides the following boot modes:

- **Normal.** Initiates a normal boot process, just like booting using the **Power** button.
- **Factory default.** Initiates a short disk test that takes approximately 5 minutes. After the disk test, a 10-minute time-out period begins. During the 10-minute time-out period, you can choose to power off the storage system without causing any data loss, and the factory default process is canceled. If you choose not to power off the storage system, after the 10-minute time-out period, the factory default process begins.



### **WARNING:**

**The factory default reboot process resets the storage system to factory settings, erases all data, resets all defaults, and reformats the disk to X-RAID.**

---

**Note:** To start the factory default process immediately, press the **Reset** button during the 10-minute time-out period.

---

- **OS reinstall.** Reinstalls the firmware from the internal flash to the disks. Use the OS reinstall boot mode when the system crashes and corrupts some configuration files. OS reinstall boot mode also resets some settings on your storage system, such as Internet protocol settings and the administrator password, to defaults.
- **Tech support.** Boots into a low-level diagnostic mode. Use the tech support boot mode only when a NETGEAR technical support representative instructs you to do so.
- **Volume read only.** Mounts a volume as read-only. Use this option when you are attempting to rescue data off a disk during a disaster recovery.
- **Memory test.** Performs a memory test. The pass or fail result is reported using the storage system's LEDs. During the test the Health LED and the UI LED light alternately. If a memory error is found, the Health LED and UI LED blink at the same time.

- **Test disk.** Performs an offline full disk test. This process can take four hours or more, depending on the size of your disks. Any problems are reported in the system logs, which you can view using the local admin page. For more information about viewing the system logs, see the *ReadyNAS OS 6.4 Software Manual*, which is available at <http://support.netgear.com/product/ReadyNAS-OS6>.

























➤ **To access the boot menu:**

1. Power off your system.
2. Using a straightened paper clip, press and hold the **Reset** button on the control panel.
3. Press and continue pressing the **Power** button on the front panel of the system until the system powers on and either the Power LED stops blinking or the Power, UI, and Health LEDs are lit.



**Note:** It takes approximately one minute for the system to enter boot mode.

4. Press and hold the **Reset** button, releasing after about one second, to scroll through the boot menu modes.

The storage system shows the boot mode options using the LEDs, as described in the following table:

Boot Mode	Status Indicator			
	Description	Health LED	UI LED	Power LED
Boot menu	Power, UI, and Health LEDs blink.			
Normal	Health LED lights.			
Factory default	UI LED lights.			
OS reinstall	UI and Health LEDs light.			
Tech support	Power LED lights.			
Volume read only	Power and Health LEDs light.			
Memory test	Power and UI LEDs light.			
Test disk	Power, UI, and Health LEDs light.			

Legend:

- Solid:   
- Blinking:   
- Off: 

5. Press and hold the **Reset** button for four seconds to confirm your boot menu selection. The system boots in the selected boot mode.

**Note:** If you do not hold the **Reset** button long enough, the press moves the system to the next selection. Repeat the press and hold for one second to scroll through to your desired selection.

## Rack Mounting

You can rack-mount the ReadyNAS 3138 using the included rack-mount ears.

Alternatively, you can use the optional sliding rail kit, order number RRAIL04-10000S. For instructions see the *1U Rail Installation Guide*, which is available at <http://support.netgear.com/product/ReadyNAS-OS6>.

# ReadyNAS 3220 and 4220

---

# 3

This chapter describes the physical features of the ReadyNAS 3220 and ReadyNAS 4220 storage systems. It includes the following sections:

- *Front Panel*
- *ReadyNAS 3220 Rear Panel*
- *ReadyNAS 4220 Rear Panel*
- *Status Information*
- *Boot Menu*
- *Rack-Mount Setup*

## Front Panel

The following figure shows the front panel of the ReadyNAS 3220 and 4220 storage systems.



**Figure 12. Front panel**

1. Drive bays with disk status LEDs
2. Control panel

The following figure shows the control panel in more detail.

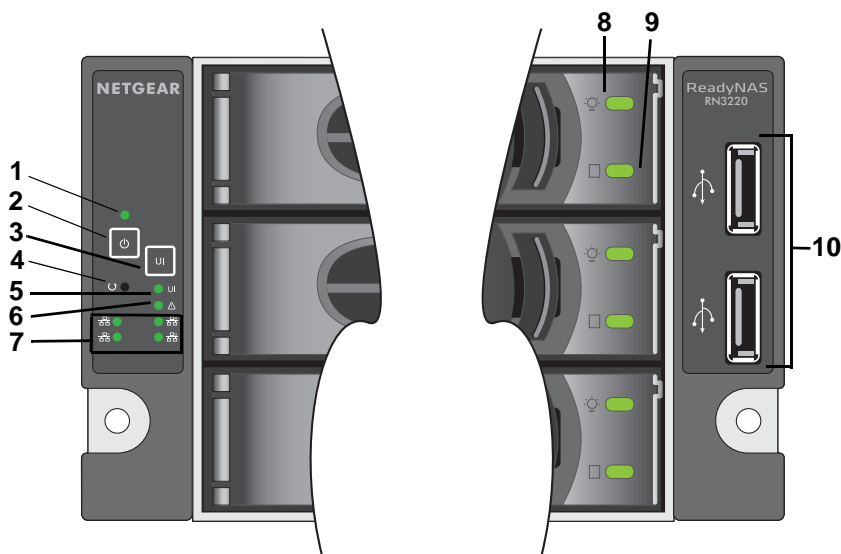

**Figure 13. Control panel**

- |                                 |                            |
|---------------------------------|----------------------------|
| 1. Power LED                    | 6. Health LED              |
| 2. Power button                 | 7. LAN LEDs                |
| 3. Unit Identifier (UID) button | 8. Disk Drive Power LED    |
| 4. Reset button                 | 9. Disk Drive Activity LED |
| 5. Unit Identifier (UID) LED    | 10. USB 2.0 ports          |

Each drive bay features a latch that releases the pop-out tray handle, as shown in the following figure.



**Figure 14. Disk tray handle and release latch**

1. Disk tray handle
2. Disk tray release latch



**WARNING:**

No matter how many hard drives are installed in your system, ensure that all drive trays remain in the drive bays to maintain proper airflow.

## ReadyNAS 3220 Rear Panel

The following figure shows the rear panel of the ReadyNAS 3220 storage systems.

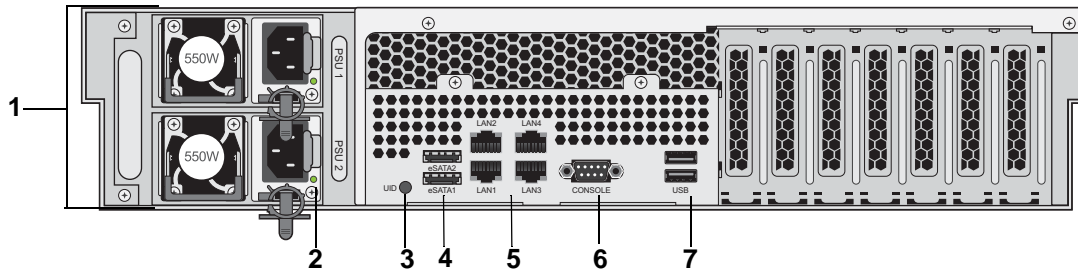

**Figure 15. Rear panel**

1. Power supplies
2. Power Supply LEDs
3. Unit Identifier (UID) LED
4. eSATA ports
5. 1-gigabit LAN ports with LED status indicators
6. Console port
7. USB 3.0 ports



## ReadyNAS 4220 Rear Panel

The following figure shows the rear panel of the ReadyNAS 4220 storage system.

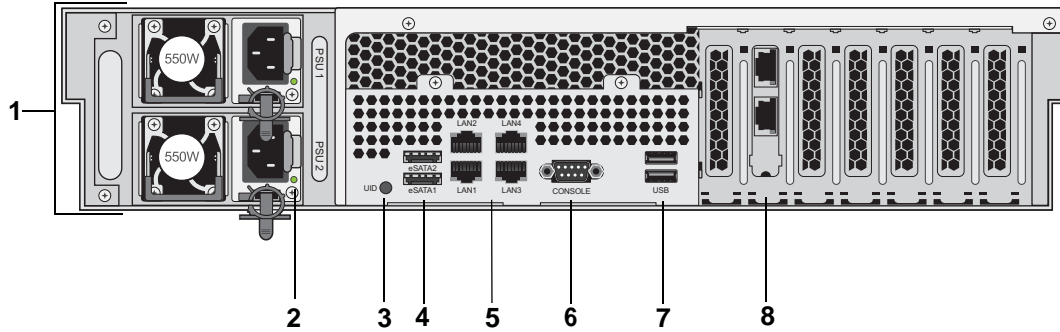

**Figure 16. Rear panel**

1. Power supplies
2. Power Supply LEDs
3. Unit Identifier (UID) LED
4. eSATA ports
5. 1-gigabit LAN ports with LED status indicators
6. Console port
7. USB 2.0 ports
8. 10-gigabit LAN ports with LED status indicators

## Status Information

You can obtain information about the status of your system by reviewing the indicators listed in the following table.

**Table 4. Status indicators**

Indicator	Description
Power LED (control panel)	The Power LED indicates these states: <ul style="list-style-type: none"> <li>• <b>Green.</b> The system is powered on.</li> <li>• <b>Amber.</b> The system is in standby mode.</li> <li>• <b>Off.</b> The system is powered off.</li> </ul>
UI LED (control panel)	The UI LED indicates these states: <ul style="list-style-type: none"> <li>• <b>Blue.</b> The system is identified: The <b>UI</b> button was pressed and the UID LED on the rear panel is lit.</li> <li>• <b>Off.</b> The system is not identified.</li> </ul>
Health LED (control panel)	The Health LED indicates these states: <ul style="list-style-type: none"> <li>• <b>Red.</b> The system needs attention. Use the local admin page to determine the problem. For more information, see the <i>ReadyNAS OS 6.4 Software Manual</i>, which is available at <a href="http://support.netgear.com/product/ReadyNAS-OS6">http://support.netgear.com/product/ReadyNAS-OS6</a>.</li> <li>• <b>Off.</b> The system is healthy.</li> </ul>
LAN LEDs (control panel)	The LAN LEDs indicate these states: <ul style="list-style-type: none"> <li>• <b>Green.</b> An Ethernet cable is connected.</li> <li>• <b>Blinking.</b> The Ethernet link is active.</li> <li>• <b>Off.</b> There is no Ethernet connection.</li> </ul>
Disk LEDs (disk trays)	The top LED indicates disk status, as follows: <ul style="list-style-type: none"> <li>• <b>On.</b> A disk is present.</li> <li>• <b>Off.</b> No disk is present.</li> </ul> The bottom LED indicates disk activity as follows: <ul style="list-style-type: none"> <li>• <b>Blinking.</b> The disk is active.</li> <li>• <b>Off.</b> There is no disk activity.</li> <li>• <b>Blinking on/off/on/off pattern.</b> The disk failed or is faulty.</li> </ul>
UI LED (rear panel)	The UI LED indicates these states: <ul style="list-style-type: none"> <li>• <b>On.</b> The system is identified: The <b>UI</b> button was pressed.</li> <li>• <b>Off.</b> The system is not identified.</li> </ul>
LAN port LEDs (rear panel)	Two LED status indicators are built into each LAN port. One LED is green and one is amber. They indicate port speed and activity as follows: <ul style="list-style-type: none"> <li>• <b>Green on, amber off.</b> 1000 Mbps connection speed, no activity.</li> <li>• <b>Green blinking, amber off.</b> 1000 Mbps connection speed, activity.</li> <li>• <b>Green off, amber on.</b> 10 Mbps or 100 Mbps connection speed, no activity.</li> <li>• <b>Green off, amber blinking.</b> 10 Mbps or 100 Mbps connection speed, activity.</li> <li>• <b>Green off, amber off.</b> No connection.</li> </ul>

## Boot Menu

Use the boot menu to restart or troubleshoot your ReadyNAS storage system. Your storage system provides the following boot modes:

- **Normal.** Initiates a normal boot process, just like booting using the **Power** button.
- **Factory default.** Initiates a short disk test that takes approximately 5 minutes. After the disk test, a 10-minute time-out period begins. During the 10-minute time-out period, you can choose to power off the storage system without causing any data loss, and the factory default process is canceled. If you choose not to power off the storage system, after the 10-minute time-out period, the factory default process begins.



### WARNING:

The factory default reboot process resets the storage system to factory settings, erases all data, resets all defaults, and reformats the disk to X-RAID.

---

**Note:** To start the factory default process immediately, press the **Reset** button during the 10-minute time-out period.

---

- **OS reinstall.** Reinstalls the firmware from the internal flash to the disks. Use the OS reinstall boot mode when the system crashes and corrupts some configuration files. OS reinstall boot mode also resets some settings on your storage system, such as Internet protocol settings and the administrator password, to defaults.
- **Tech support.** Boots into a low-level diagnostic mode. Use the tech support boot mode only when a NETGEAR technical support representative instructs you to do so.
- **Volume read only.** Mounts a volume as read-only. Use this option when you are attempting to rescue data off a disk during a disaster recovery.
- **Memory test.** Performs a memory test. The pass or fail result is reported using the storage system's LEDs. Contact a NETGEAR technical support representative to interpret memory test results.
- **Test disk.** Performs an offline full disk test. This process can take four hours or more, depending on the size of your disks. Any problems are reported in the system logs, which you can view using the local admin page. For more information about viewing the system logs, see the *ReadyNAS OS 6.4 Software Manual*, which is available at <http://support.netgear.com/product/ReadyNAS-OS6>.

























### ➤ To access the boot menu:

1. Power off your system.
2. Using a straightened paper clip, press and hold the **Reset** button.







3. Press the **Power** button on the front panel of the system.  
The system powers on.
4. Continue to press the **Reset** button until the Power, UI, and Health LEDs are blinking.

**Note:** It takes approximately one minute for the system to enter boot mode.

5. Press and release the **Reset** button to scroll through the boot menu modes.  
The storage system shows the boot mode options using the LEDs, as described in the following table:

Boot Mode	Status Indicator			
	Description	Power LED	UI LED	Health LED
Boot menu	Power, UI, and Health LEDs blink.			
Normal	Health LED lights.			
Factory default	UI LED lights.			
OS reinstall	UI and Health LEDs light.			
Tech support	Power LED lights.			
Volume read only	Power and Health LEDs light.			
Memory test	Power and UI LEDs light			
Test disk	Power, UI, and Health LEDs light.			

Legend:

- Solid:   
- Blinking:   
- Off: 

6. Press and hold the **Reset** button to confirm your boot menu selection.  
The system boots in the selected boot mode.

## Rack-Mount Setup

Use the rack-mount hardware included with your ReadyNAS 3220 or 4220 storage system to install it in a rack. Read [Rack-Mount Precautions](#) on page 78.



### DANGER:

A system with installed drives can weigh more than 80 pounds. To avoid injury or damage to the equipment, perform the rack-mount installation with appropriate assistance.

## Installation

Read these instructions in their entirety before you begin. Locate the shipping carton, remove the rack-mounting kit, and prepare to work with it.

The rack-mounting kit contains two rail assemblies. Each assembly consists of two sections:

- An inner fixed chassis rail that secures directly to the system's chassis
- An outer fixed rack rail that secures directly to the rack itself

### ➤ To install the system into a rack:

1. Extend the rail assembly by pulling it outward.
2. Press the release tab and separate the inner rail from the outer assembly.

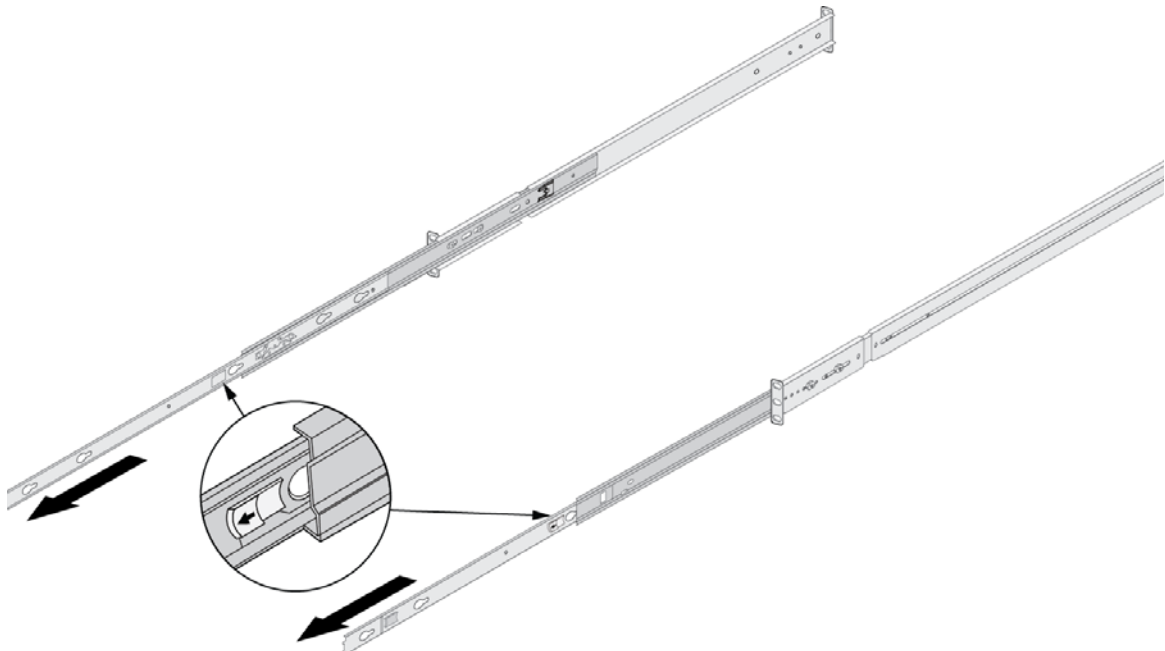

3. Use the provided mounting screws to mount the inner rails to the system chassis, as follows:
  - a. Fasten the backs of the outer rails to the rack with screws.
  - b. Press the release to extend the rails.
  - c. Hang the hooks of the rails in the rack holes, and fasten the rails to the rack.

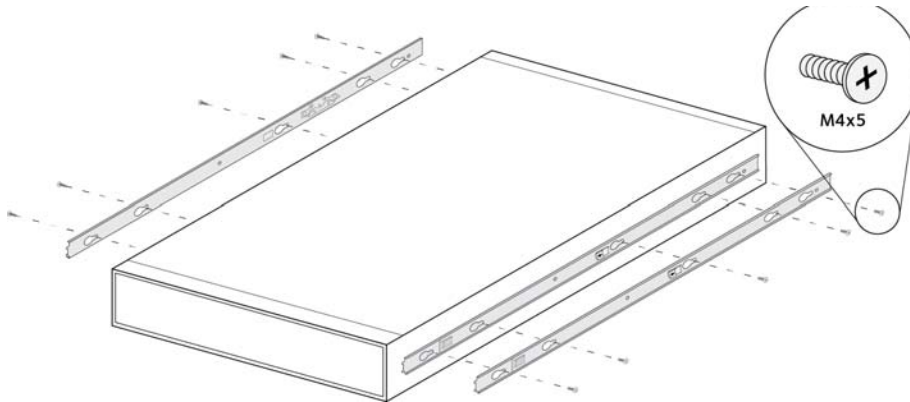

4. Attach the chassis to the rack, as follows:
  - a. Extend the ball shuttle to the very front.
  - b. Align the rails and push the chassis in.
  - c. Secure the handles to the outer rails with screws.

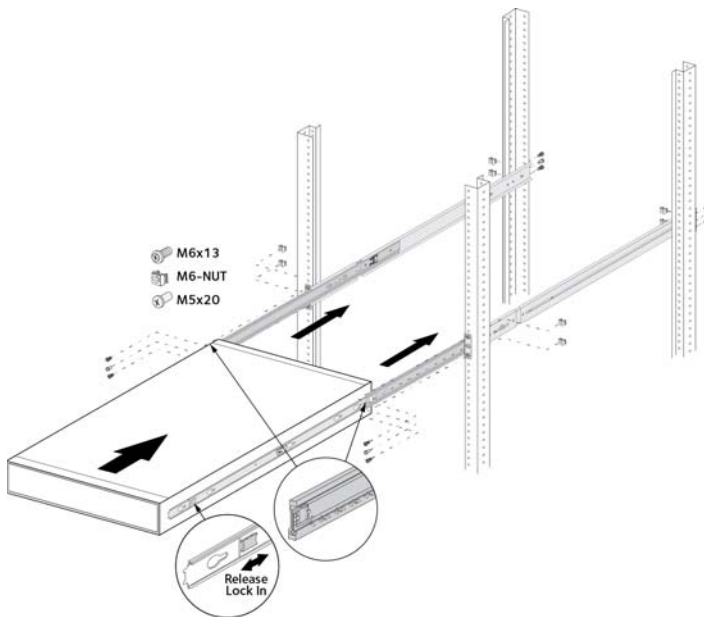

The rack-mount installation is complete.

# 4 Disks

---

# 4

This chapter describes how to reformat, add, and replace disks in your ReadyNAS OS 6 storage system.

For information about configuring disks on your storage system, see the *ReadyNAS OS 6.4 Software Manual*, which is available at <http://support.netgear.com/product/ReadyNAS-OS6>.

This chapter includes the following topics:

- *Disk Tray*
- *Supported Disks*
- *Previously Formatted Disks*
- *Add a Disk*
- *Replace a Disk*

## Disk Tray

The following figure shows the features of the disk tray.

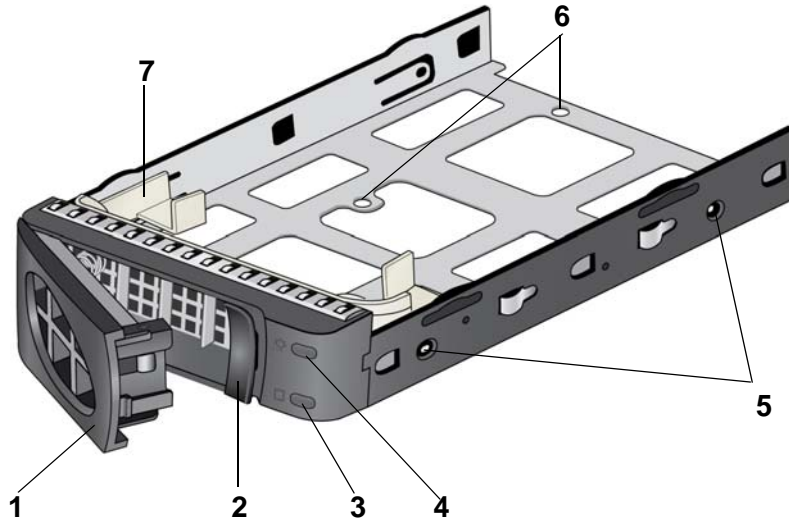

**Figure 17. Disk tray**

1. Disk tray handle
2. Disk tray release latch
3. Fault LED
4. Disk Activity LED
5. Disk screw holes (for 3.5-inch disk)
6. Disk screw holes (for 2.5-inch disk)
7. Removable plastic air blocker

### **IMPORTANT:**

**To maintain adequate airflow, follow these precautions concerning disk trays:**

- Make sure that all disk trays remain in the drive bays, even if no disk is installed in the tray.
- Install the plastic air blocker in empty disk trays.



## Supported Disks

Use only supported SATA hard disk drives (HDDs) or solid-state drives (SSDs) in your ReadyNAS storage system. If you use disks that are not supported, NETGEAR technical support will not provide assistance. For a list of supported disks, see the NETGEAR Hardware Compatibility List at <http://www.netgear.com/readynas-hcl>.

## Previously Formatted Disks

You can use previously formatted disks with your ReadyNAS OS 6 storage system, but you might need to reformat them or migrate a volume to the new system first.

Previously formatted disks must appear on the NETGEAR Hardware Compatibility List, which is available at <http://www.netgear.com/readynas-hcl>.

## Reformat Previously Formatted Disks

If you want to use disks that were previously formatted for an operating system other than ReadyNAS OS 6 (for example, Windows or RAIDiator), you must reformat the disks.

If you want to use disks from another ReadyNAS OS 6 storage system, see [Migrate a Volume](#) on page 50.

---

**Note:** If you try to use previously formatted disks in a system that does not contain any other disks, the system does not boot and ReadyCLOUD does not discover your device. If you use RAIDar to discover your device, RAIDar displays a “Corrupt Root” error message.

If you try to use previously formatted disks in a system that already contains usable disks, the system does not reformat or use the previously formatted disks. Any data on the previously formatted disks remains intact.

---

The following instructions describe how to reformat previously formatted disks in a ReadyNAS OS 6 system. This procedure assumes that the system does not contain any other disks.

➤ **To reformat previously formatted disks with a diskless ReadyNAS OS 6 system:**

1. Gracefully shut down the storage system.

For information about how to gracefully shut down your system, see the Preferred Shutdown section of the chapter that describes your system.

2. Install the disk.

For more information, see [Add a Disk](#) on page 51.

3. Reset the system to its factory default settings.

**WARNING:**

**This process erases all data and reformats all disks into a single X-RAID volume. If you want to preserve the data on the disks, you must back up the data to an external drive before using the disks in your ReadyNAS storage system.**

For information about how to reset the system to its factory default settings, see the Boot Menu section of the chapter that describes your system.

The disk is reformatted and becomes available for use with your ReadyNAS OS 6 storage system.

## Migrate a Volume

You can migrate a volume from one ReadyNAS OS 6 storage system to another, as long as you migrate every disk in the volume. For example, if you want to migrate a volume that contains two disks, you must add both disks to the new system. If you add only part of a volume to the new system, the system recognizes the disk as a degraded volume.

If your ReadyNAS storage system is operating with one or more disks, you can add disks while the system is running. The new system recognizes the migrated volume and its data. For more information about adding a disk while the system is running, see [Add a Disk](#) on page 51.

If no disks are installed on your ReadyNAS, perform the following procedure.

➤ **To migrate a volume to a diskless ReadyNAS OS 6 system:**

1. Gracefully shut down the new (diskless) storage system.

For information about how to gracefully shut down your system, see the Preferred Shutdown section of the chapter that describes your system.

2. Remove each disk in the volume from the old system.
3. Install each disk in the volume into the new storage system.

For more information, see [Add a Disk](#) on page 51.

4. Turn on the new system by pressing the **Power** button.

The new system recognizes the migrated volume and its data.

## Add a Disk

You can add a 3.5-inch hard disk drive, 2.5-inch hard disk drive, or a 2.5-inch solid-state drive to an empty disk bay.

If you want to add a previously formatted disk to your storage system, see the instructions in [Previously Formatted Disks](#) on page 49.

### ➤ To add a 3.5-inch hard disk drive (HDD):

1. Determine whether you must shut down your system:
  - If you are adding disks to a diskless system, gracefully shut down the system.  
For information about how to gracefully shut down your system, see the Preferred Shutdown section of the chapter that describes your system.
  - If your system is operating with one or more disks, you can add disks while the system is running. You do not need to shut down the system.
2. Press the disk tray release latch.

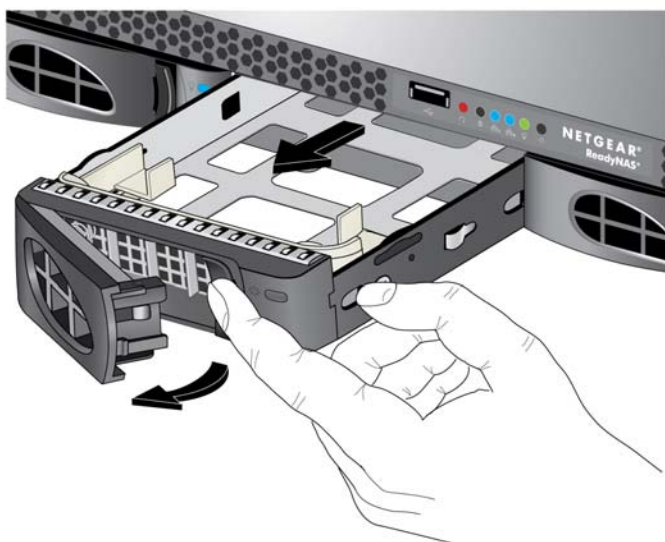

The tray handle pops out.

3. Pull out the disk tray.

4. Remove the plastic air blocker from the disk tray.

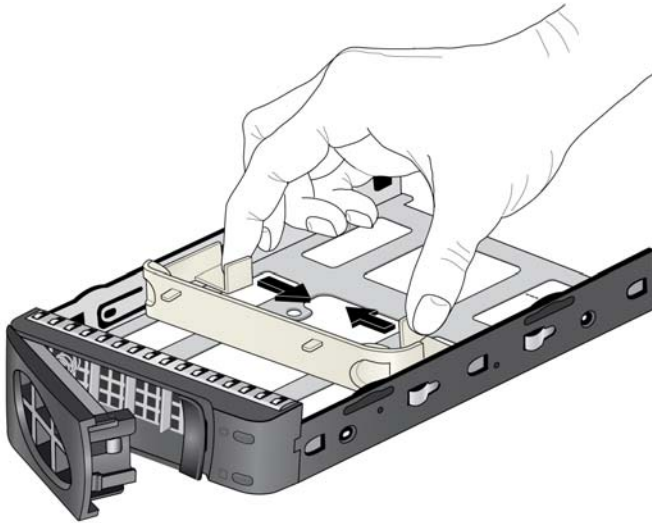

5. Place the new 3.5-inch HDD in the disk tray.
6. Secure the HDD in the tray using the screws that came with your storage system.



Make sure that the hard disk connectors face the interior of the disk tray when you assemble the disk.

7. Slide the disk tray back into the drive bay of the system.
8. Press the disk tray handle until it latches closed.

The disk tray is secured in the drive bay.

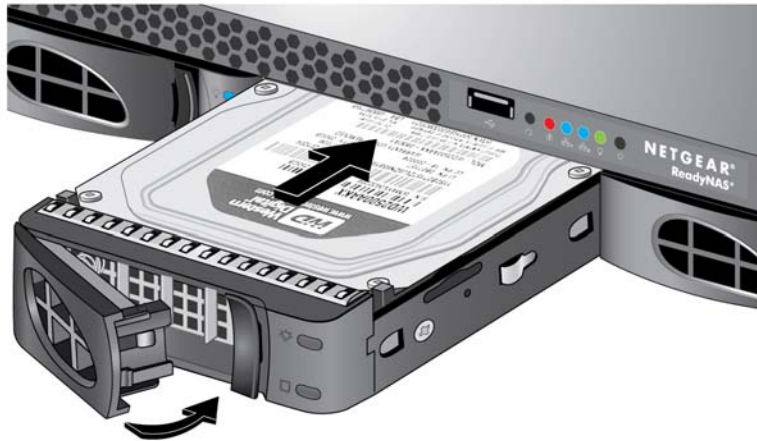

9. If necessary, turn on your system by pressing the **Power** button.

If the disk that you added was not previously formatted, the system uses the disk in one of the following ways:

- If you are adding the disk to a system that uses X-RAID, the system automatically determines whether the disk is used for protection or storage. The new disk is incorporated in the background while you continue to use your system.
- If you are adding the disk to a system that uses Flex-RAID, the disk becomes available for use. You use the local admin page to manually configure the new disk.

For more information about X-RAID, Flex-RAID, and using the local admin page, see the *ReadyNAS OS 6.4 Software Manual*, which is available at <http://support.netgear.com/product/ReadyNAS-OS6>.

➤ **To add a 2.5-inch hard disk drive (HDD) or 2.5-inch solid-state drive (SSD):**

1. Determine whether you must shut down your system:
  - If you are adding disks to a diskless system, gracefully shut down the system.  
For information about how to gracefully shut down your system, see the Preferred Shutdown section of the chapter that describes your system.
  - If your system is operating with one or more disks, you can add disks while the system is running. You do not need to shut down the system.
2. Press the disk tray release latch.

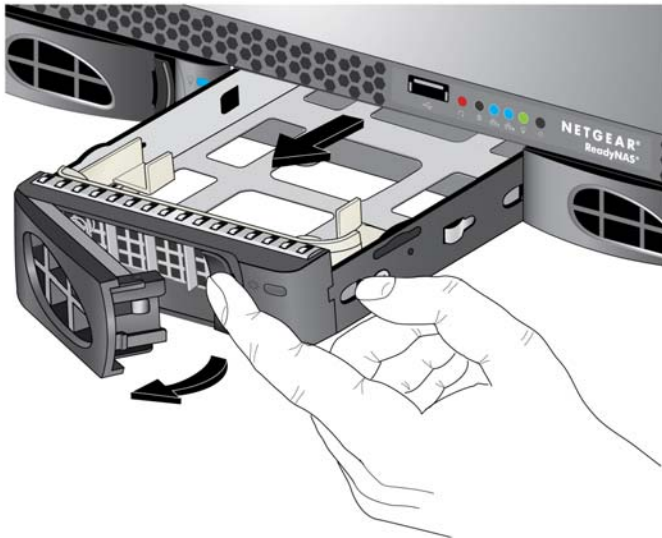

The tray handle pops out.

3. Pull out the disk tray.
4. Remove the plastic air blocker from the disk tray.

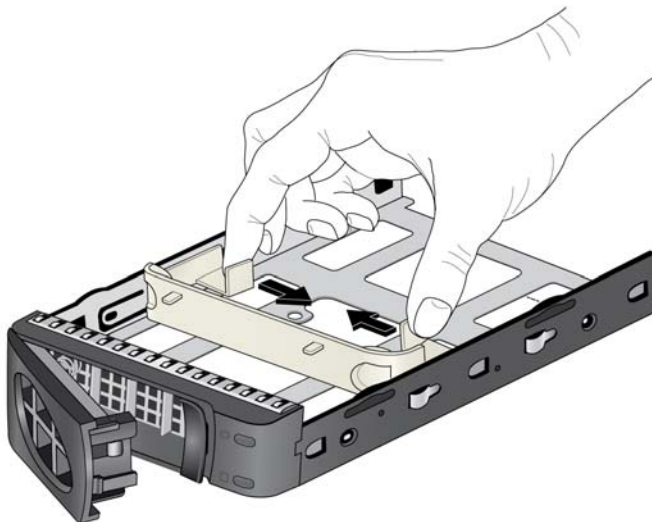

5. Place the new 2.5-inch HDD or SSD in the disk tray.

- Secure the drive in the tray using the screws that came with your storage system.

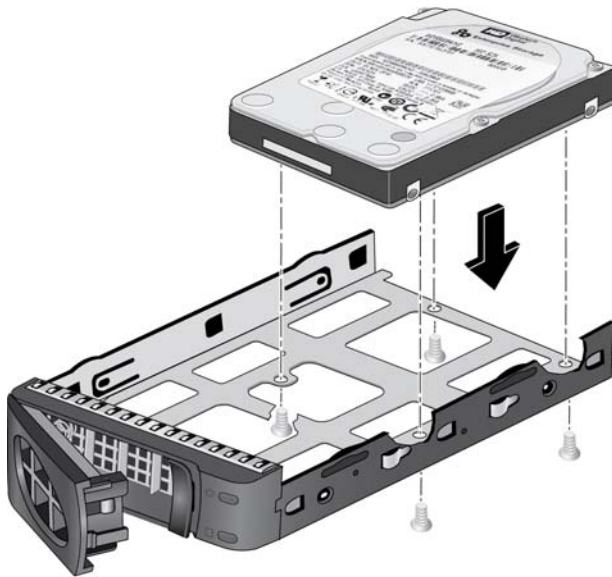

Make sure that the hard disk connectors face the interior of the disk tray when you assemble the disk.

- Slide the disk tray back into the drive bay of the system.
- Press the disk tray handle until it latches closed.

The disk tray is secured in the drive bay.



- If necessary, turn on your system by pressing the **Power** button.

If the disk that you added was not previously formatted, the system uses the disk in one of the following ways:

- In a system that uses X-RAID, the system automatically determines whether the disk is used for protection or storage. The new disk is incorporated in the background while you continue to use your system.

- In a system that uses Flex-RAID, the disk becomes available for use. You use the local admin page to manually configure the new disk.

For more information about X-RAID, Flex-RAID, and using the local admin page, see the *ReadyNAS OS 6.4 Software Manual*, which is available at <http://support.netgear.com/product/ReadyNAS-OS6>.

## Replace a Disk

If your volumes use a protected RAID configuration, your system can recover from the failure of a disk. When you replace the failed disk, the system rebuilds the volume using the new disk and no data from the volume is lost.

Each disk tray includes a Fault LED that lights solid red when its disk fails. You can also use the local admin page to set up email alerts that notify you when a disk fails. In addition, the local admin page provides information about the failed disk.

For information about RAID configurations, setting up email alerts, and using the local admin page, see the *ReadyNAS OS 6.4 Software Manual*, which is available at <http://support.netgear.com/product/ReadyNAS-OS6>.

ReadyNAS supports hot-swap drive bays, so you do not need to power down your storage system when replacing a disk.

If you are replacing a disk with a previously formatted disk, see the instructions in [Previously Formatted Disks](#) on page 49.



### **WARNING:**

**Replace one disk at a time. Wait for the volume to resynchronize your data before replacing another disk. If you attempt to replace more than one disk at a time, the system crashes.**



➤ **To replace a 3.5-inch hard disk drive (HDD):**

1. Press the disk tray release latch.

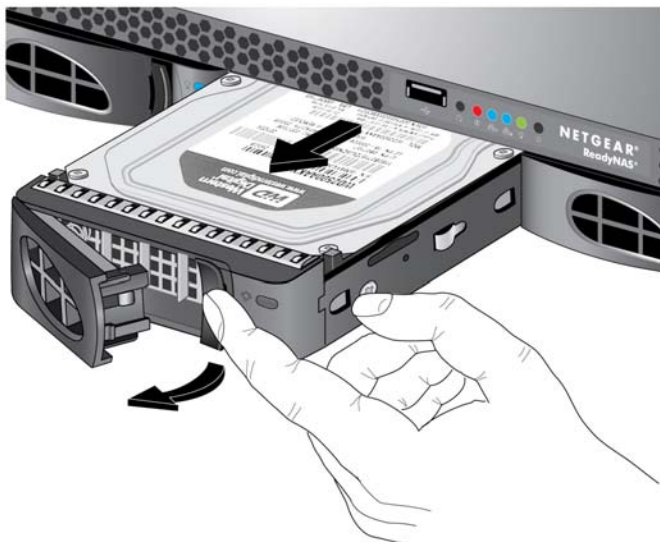

The disk tray handle pops out.

2. Pull out the disk tray.
3. Remove the screws and the old 3.5-inch HDD from the tray.
4. Place the new 3.5-inch HDD in the disk tray.
5. Secure the HDD in the tray using the screws.

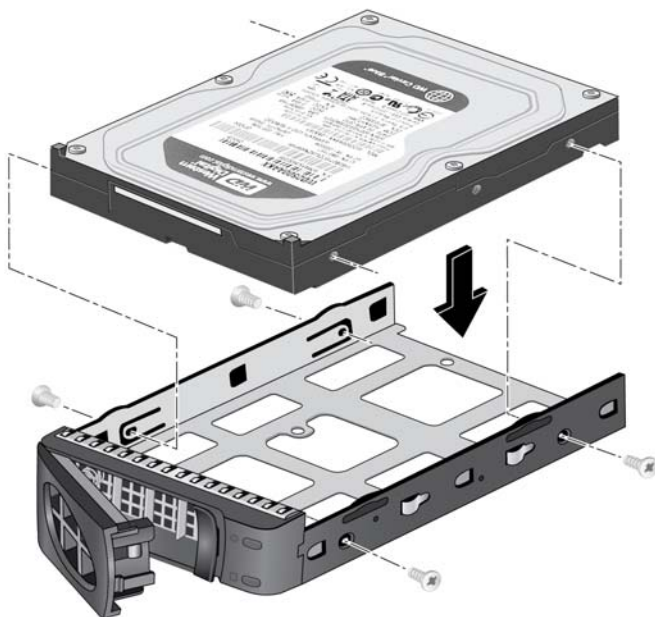

Make sure that the hard disk connectors face the interior of the disk tray when you assemble the disk.

6. Slide the disk tray back into the drive bay of the system.
7. Press the disk tray handle until it latches closed.

The disk tray is secured in the drive bay.



If the volume that contained the failed disk uses a protected RAID configuration, the system automatically resynchronizes the volume using the new disk. Resynchronization might take several hours, depending on the disk size. You can continue to use your storage system, although access is slower until the volume resynchronization finishes.

For more information about RAID configurations, see the *ReadyNAS OS 6.4 Software Manual*, which is available at <http://support.netgear.com/product/ReadyNAS-OS6>.

➤ **To replace a 2.5-inch hard disk drive (HDD) or 2.5-inch solid-state drive (SSD):**

1. Press the disk tray release latch.

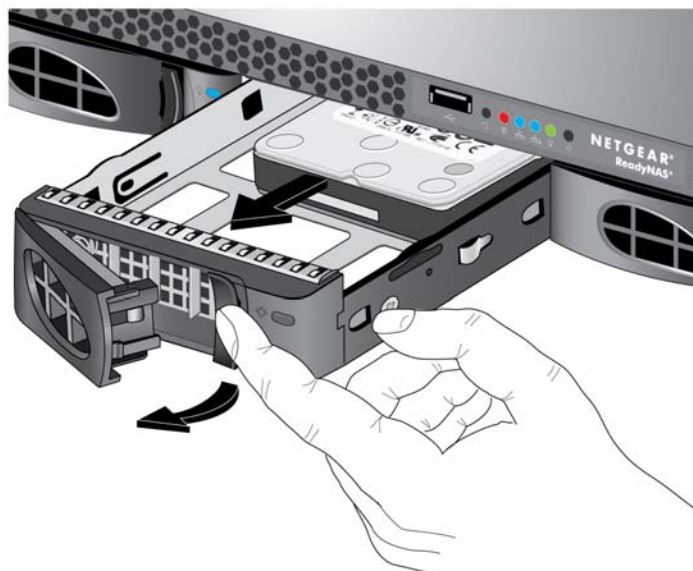

The disk tray handle pops out.

2. Pull out the disk tray.
3. Remove the screws and the old 2.5-inch HDD or SSD from the tray.
4. Place the new 2.5-inch HDD or SSD in the disk tray.
5. Secure the drive in the tray using the screws.

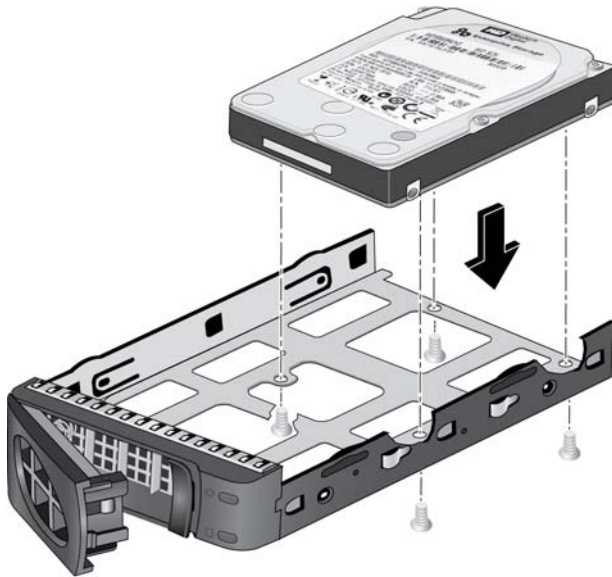

Make sure that the hard disk connectors face the interior of the disk tray when you assemble the disk.

6. Slide the disk tray back into the drive bay of the system.
7. Press the disk tray handle until it latches closed.

The disk tray is secured in the drive bay.

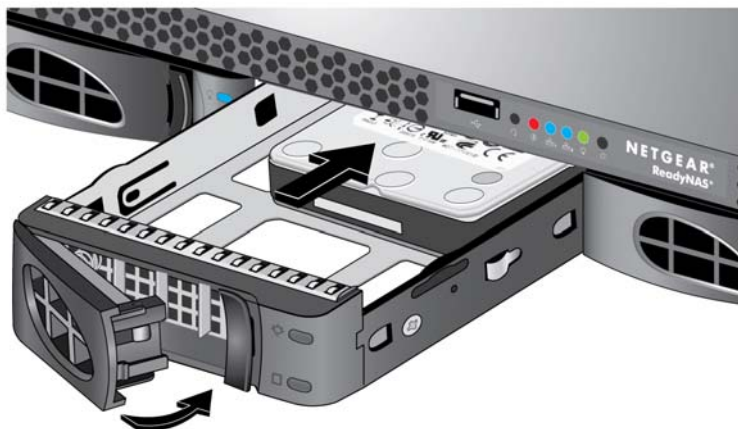

If the volume that contained the failed disk uses a protected RAID configuration, the system automatically resynchronizes the volume using the new disk. Resynchronization might take several hours, depending on the disk size. You can continue to use your storage system, although access is slower until the volume resynchronization finishes.

For more information about RAID configurations, see the *ReadyNAS OS 6.4 Software Manual*, which is available at <http://support.netgear.com/product/ReadyNAS-OS6>.

# Maintenance

---

# 5

This chapter describes how to perform maintenance activities like replacing a fan or on-board battery. It includes the following topics:

- *Access the Inside of the Storage System*
- *Replace a Fan*
- *Replace the On-Board Battery*

## Access the Inside of the Storage System

You must access the inside of the system to replace a fan or on-board battery.



**WARNING:**

Ensure that the chassis cover is in place when the system is operating to allow proper cooling. If you do not strictly follow this practice, out-of-warranty damage to the system can occur.

➤ **To access the inside of a ReadyNAS 2120, 3130 or 3138 storage system:**

1. If your system is mounted in a rack, grasp the two handles on either side and pull the system straight out until it locks.

The system is locked when you hear a click sound.

2. Remove the four screws holding the top cover in place.



3. Slide the top cover back.

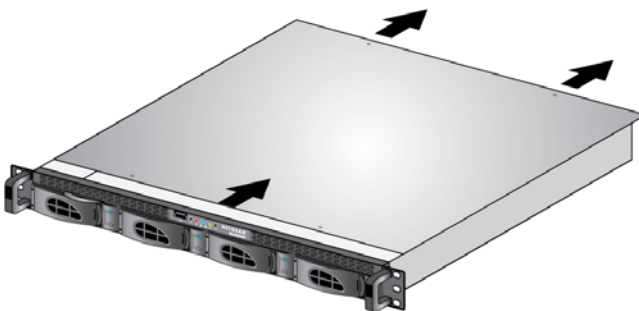

4. Lift the top cover from the chassis.

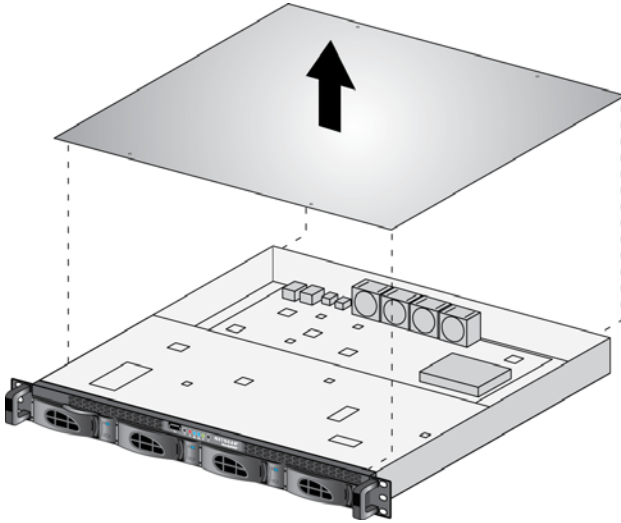

You can now access the inside of the system.

➤ **To access the inside of a ReadyNAS 3220 or 4220 storage system:**

1. If your system is mounted in a rack, grasp the two handles on either side and pull the system straight out until it locks.  
The system is locked when you hear a click sound.
2. Remove the four screws holding the top cover in place.

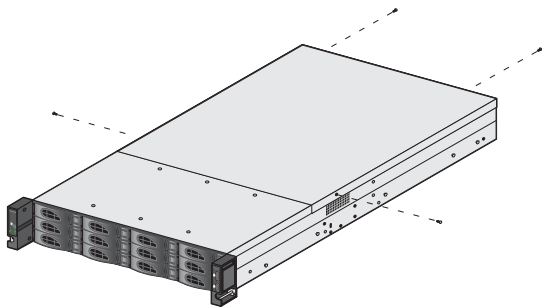

3. Slide the top cover back.

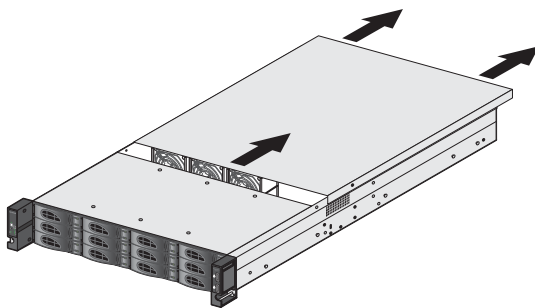

4. Lift the top cover from the chassis.

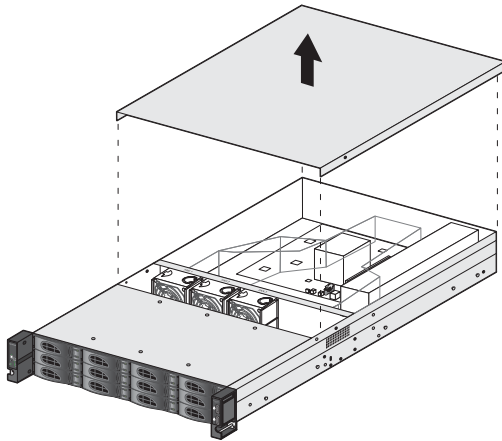

You can now access the inside of the system.

## Replace a Fan

If a fan fails, the remaining fans ramp up to full speed, the Error LED on the control panel lights, and an email alert is sent to the system administrator. Replace a failed fan as soon as possible. Remove the top chassis cover while the system is still running to determine which fan failed.

Fans are hot-pluggable, so you do not need to power down your system when replacing a fan.

➤ **To replace a fan on a ReadyNAS 2120, 3130 or 3138 storage system:**

1. Remove the chassis cover.

For more information, see [Access the Inside of the Storage System](#) on page 62.

2. Disconnect the fan's power connections.



3. Pull up on the fan gently to remove it from the housing.

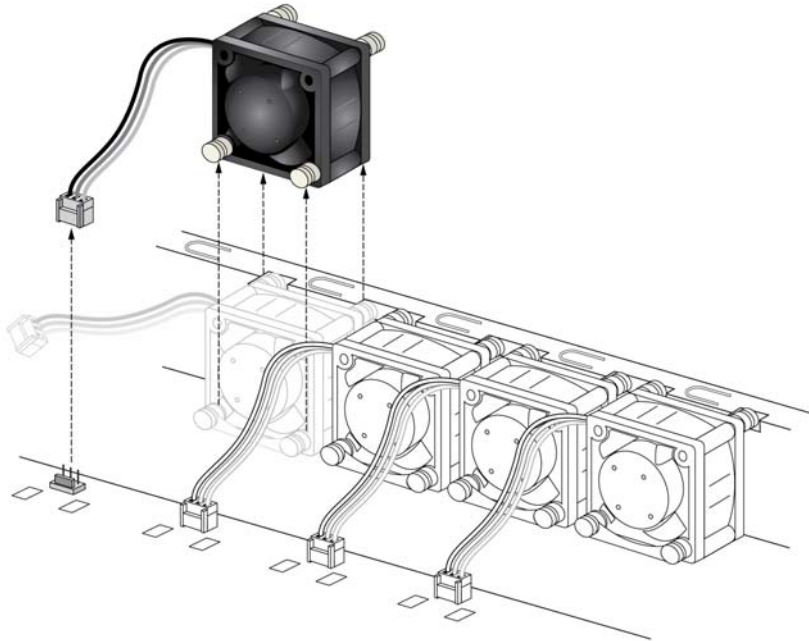

4. Remove the four pegs that hold the fan in the housing.

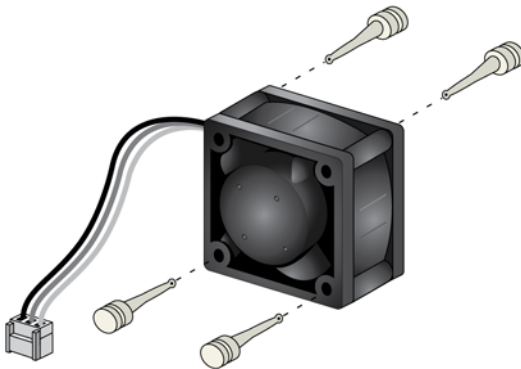

5. Insert the four pegs into holes in the replacement fan.
6. Insert the replacement fan into the housing.
7. Make sure that the grooves in the pegs fit into the housing and hold the fan in place.

8. Connect the replacement fan's power connections.

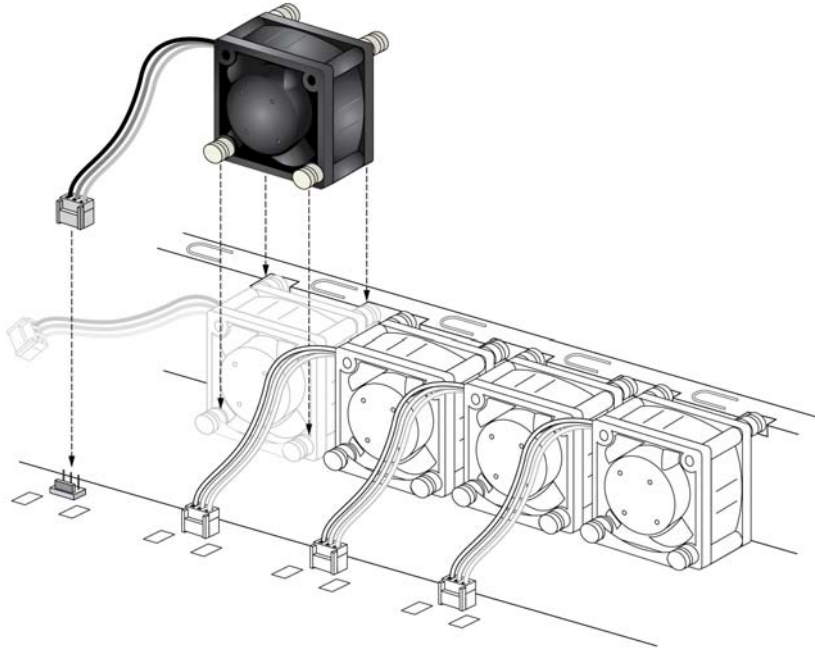

If the system power is on, the hot-plug feature causes the fan to start immediately.

➤ **To replace a fan on a ReadyNAS 3220 or 4220 storage system:**

1. Remove the chassis cover.

For more information, see [Access the Inside of the Storage System](#) on page 62.

2. Disconnect the fan's power connections.

3. Squeeze the latches on top of the fan and pull up gently to remove the fan from the housing.

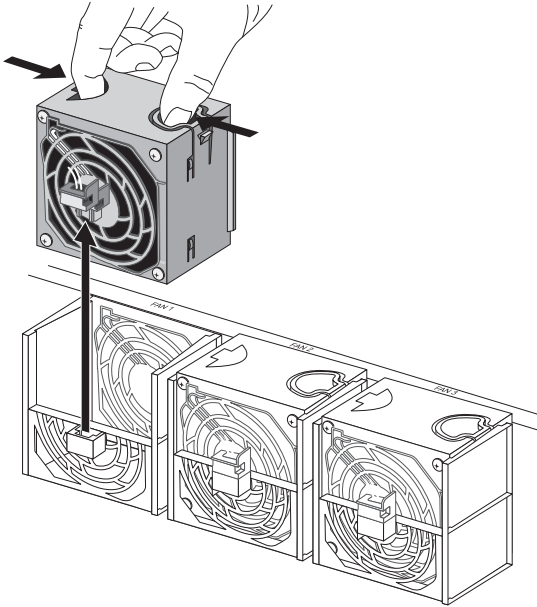

4. Insert the replacement fan into the housing.
5. Connect the replacement fan's power connections.

If the system power is on, the hot-plug feature causes the fan to start immediately.

## Replace the On-Board Battery

Replace the battery only with the same or an equivalent type recommended by NETGEAR. Dispose of used batteries according to the manufacturer's instructions.



### **DANGER:**

Installing the on-board battery upside down, which reverses its polarities, creates a risk of explosion. Take care to install the battery correctly.

#### ➤ **To replace the battery of a ReadyNAS 2120, 3130 or 3138 storage system:**

1. Open the system and locate the battery holder.
2. Remove the old battery.

3. Install the new battery.

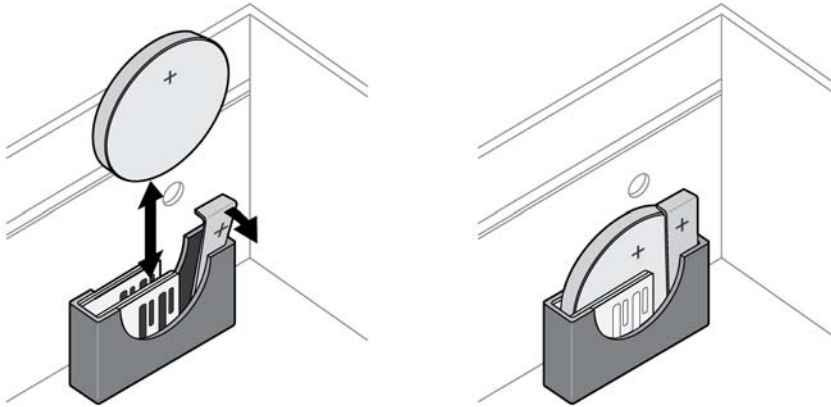

Take care to install the new battery with the correct side up.

- **To replace the battery of a ReadyNAS 3220 or 4220 storage system:**

1. Open the system and locate the battery holder.
2. Remove the old battery.
3. Install the new battery.

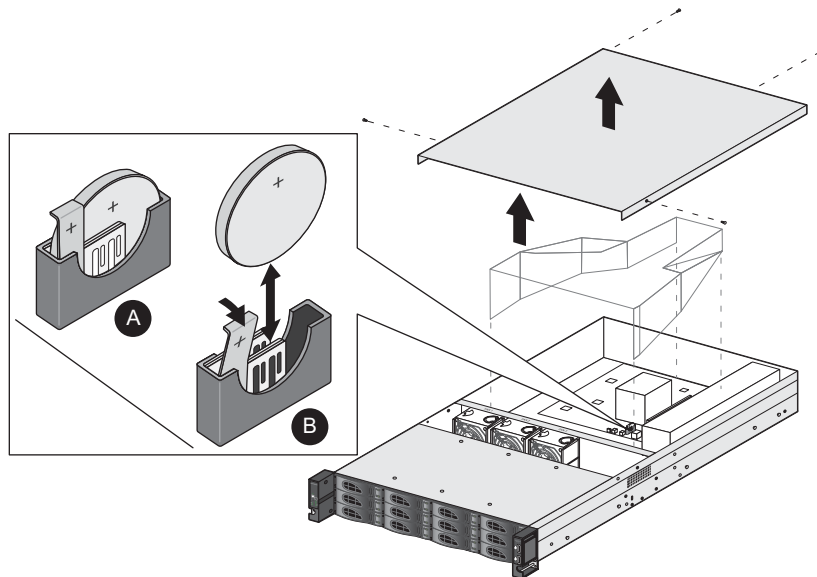

Take care to install the new battery with the correct side up.

# A Defaults and Technical Specifications

---



This appendix includes the following sections:

- *Factory Default Settings*
- *ReadyNAS 2120 and 2120 v2 Technical Specifications*
- *ReadyNAS 3130 Technical Specifications*
- *ReadyNAS 3138 Technical Specifications*
- *ReadyNAS 3220 Technical Specifications*
- *ReadyNAS 4220 Technical Specifications*
- *Safety Warnings*

## Factory Default Settings

The following table lists factory default settings for ReadyNAS OS 6 rack-mount storage systems.

**Table 5. ReadyNAS OS 6 factory default settings**

Feature	Default
Login	
Default IP address	The default IP address for the ReadyNAS is assigned by the local router (DHCP server).  If a router does not assign an IP address, the ReadyNAS defaults to the IP address https://169.254.x.x, where the last two octets are randomly generated based on the system's MAC address.
Admin user name (case-sensitive)	admin
Admin login password (case-sensitive)	password
Management	
System configuration	ReadyNAS local admin page web-based configuration and status monitoring
Discovery and multistorage system status monitoring utility	Web-accessed ReadyCLOUD
LAN connections	
MAC address	See product label
MTU size	1500
Ethernet port	AutoSense 10/100/1000BASE-T, RJ-45
LAN IP address	DHCP acquired

## ReadyNAS 2120 and 2120 v2 Technical Specifications

The ReadyNAS 2120 and 2120 v2 storage systems meet the following technical specifications:

### General:

- Marvell Armada XP 1.2 GHz (ReadyNAS 2120)
- Marvell Armada XP 1.6 GHz (ReadyNAS 2120 v2)
- 2 GB memory

- Four-bay storage
- Two eSATA ports
- One USB 2.0 port (front)
- Two USB 3.0 ports (back)
- Two LAN ports

**Physical dimensions (h x w x d):**

- 43.5 x 430 x 308 mm (1.7 x 16.9 x 12.1 in.)

**Physical weight:**

- 3.5 kg (8.89 lb) without disks

**Power consumption:**

- BTU at full power supply utilization: 38W
- In operation: 38W
- Power off (Wake On LAN): 1.4W
- Power off: 0.307W

**Electrical:**

- Internal 200W server-rated AC power supply
- Input: 100–240 VAC, 50/60 Hz

**Environmental requirements:**

- Operating temperature: 0 to 40°C (32° to 104°F)
- Operating humidity: 20 to 80% relative humidity (noncondensing)
- Storage temperature: –20 to 70°C (–4 to 158°F)
- Storage humidity: 5 to 95% relative humidity (noncondensing)
- Software-controlled 3 mm x 40 mm chassis cooling fan

**Certifications:**

- FCC Class B, CE Class B, RoHS, VCCI Class B

## ReadyNAS 3130 Technical Specifications

The ReadyNAS 3130 storage system meets the following technical specifications:

### General:

- Intel dual core Atom™ processor C2338, 1.7 GHz, 1 MB cache
- 2 GB memory
- Four-bay storage
- Two eSATA ports
- One USB 2.0 port (front)
- Two USB 3.0 ports (back)
- Four Gigabit LAN ports

### Physical dimensions (h x w x d):

- 44 x 486 x 406 mm (1.7 x 19.1 x 16.0 in.)

### Physical weight:

- 5.21 kg (11.46 lb) without disks

### Power consumption:

- BTU at full power supply utilization: 73W
- In operation: 55W
- Power off (Wake On LAN): 1.5W
- Power off: 0.28W (230 VAC) 0.17W (115 VAC)

### Electrical:

- Internal 180W server-rated AC power supply
- Input: 100–240 VAC, 3-1.5A, 50/60 Hz

### Environmental requirements:

- Operating temperature: 0 to 40°C (32° to 104°F)
- Operating humidity: 20 to 80% relative humidity (noncondensing)
- Storage temperature: –20 to 70°C (–4 to 158°F)
- Storage humidity: 5 to 95% relative humidity (noncondensing)
- Software-controlled 3 mm x 40 mm chassis cooling fan

### Certifications:

- FCC Class A, CE Class A, RoHS, VCCI Class A



## ReadyNAS 3138 Technical Specifications

The ReadyNAS 3138 storage system meets the following technical specifications:

### General:

- Intel quad core Atom™ processor, 2.4 GHz, 2 MB cache
- 4 GB memory
- Four-bay storage
- Two eSATA ports
- One USB 2.0 port (front)
- Two USB 3.0 ports (back)
- Four Gigabit LAN ports

### Physical dimensions (h x w x d):

- 44 x 486 x 406 mm (1.7 x 19.1 x 16.0 in.)

### Physical weight:

- 5.21 kg (11.46 lb) without disks

### Power consumption:

- BTU at full power supply utilization: 73W
- In operation: 55W
- Power off (Wake On LAN): 1.5W
- Power off: 0.28W (230 VAC) 0.17W (115 VAC)

### Electrical:

- Internal 180W server-rated AC power supply
- Input: 100–240 VAC, 3-1.5A, 50/60 Hz

### Environmental requirements:

- Operating temperature: 0 to 40°C (32° to 104°F)
- Operating humidity: 20 to 80% relative humidity (noncondensing)
- Storage temperature: –20 to 70°C (–4 to 158°F)
- Storage humidity: 5 to 95% relative humidity (noncondensing)
- Software-controlled 3 mm x 40 mm chassis cooling fan

### Certifications:

- FCC Class A, CE Class A, RoHS, VCCI Class A

## ReadyNAS 3220 Technical Specifications

The ReadyNAS 3220 storage system meets the following technical specifications:

### General:

- Intel Core i3-3220, 65W, 3.3 GHz, 3 MB cache
- 4 GB memory
- Twelve-bay storage
- Two eSATA ports
- Two USB 2.0 ports (front)
- Two USB 3.0 ports (back)
- Four Gigabit LAN ports

### Physical dimensions (h x w x d):

- 707 mm x 445 mm x 88 mm (27.8 in. x 17.5 in. x 3.4 in.)

### Physical weight:

- 11.96 kg (26.36 lb) without disks

### Power consumption:

- In operation: 92W
- Power off (Wake On LAN): 1W

### Electrical:

- Internal 550W server-rated AC power supply
- Input: 100–240 VAC, 50/60 Hz

### Environmental requirements:

- Operating temperature: 0 to 40°C (32° to 104°F)
- Operating humidity: 20 to 80% relative humidity (noncondensing)
- Storage temperature: –20 to 70°C (–4 to 158°F)
- Storage humidity: 10 to 90% relative humidity (noncondensing)
- Software-controlled 3 mm x 80 mm chassis cooling fan

### Certifications:

- FCC Class A, CE Class A, RoHS, VCCI Class A

## ReadyNAS 4220 Technical Specifications

The ReadyNAS 4220 storage system meets the following technical specifications:

### General:

- Intel Xeon E3-1225 v2, 95W, 3.2 GHz, 8 MB cache
- 4 GB memory
- Twelve-bay storage
- Two eSATA ports
- Two USB 2.0 ports (front)
- Two USB 3.0 ports (back)
- Four Gigabit LAN ports

### Physical dimensions (h x w x d):

- 707 mm x 445 mm x 88 mm (27.8 in. x 17.5 in. x 3.4 in.)

### Physical weight:

- 11.96 kg (26.36 lb) without disks

### Power consumption:

- In operation: 168W
- Power off (Wake On LAN): 2.9W

### Electrical:

- Internal 550W server-rated AC power supply
- Input: 100–240 VAC, 50/60 Hz

### Environmental requirements:

- Operating temperature: 0 to 40°C (32° to 104°F)
- Operating humidity: 20 to 80% relative humidity (noncondensing)
- Storage temperature: –20 to 70°C (–4 to 158°F)
- Storage humidity: 10 to 90% relative humidity (noncondensing)
- Software-controlled 3 mm x 80 mm chassis cooling fan

### Certifications:

- FCC Class A, CE Class A, RoHS, VCCI Class A

## Safety Warnings

1. The equipment contains no operator access areas and is certified for installation only by trained personnel, according to the installation instructions provided with each storage system.
2. Install the socket-outlet near the equipment in an easily accessible location.
3. Observe the on-board battery precautions. Follow the battery replacement instructions explained in [Replace the On-Board Battery](#) on page 67.



### **DANGER:**

**Replacing the battery with an incorrect type creates a danger of explosion. Replace the battery the same or an equivalent type recommended by NETGEAR only. Dispose of used batteries according to the manufacturer's instructions.**

**Installing the on-board battery upside down, which reverses its polarities, creates a risk of explosion. Take care to install the battery correctly.**

4. Connect the storage systems and their associated LAN connections only to equipment within the same building.
5. Slide-mounted or rail-mounted equipment is not to be used as a shelf or a work space.



## Electrical Safety Precautions

Follow basic electrical safety precautions to protect yourself from harm and the ReadyNAS from damage:

- Be aware of the locations of the **Power On/Off** switch on the chassis as well as the room's emergency power-off switch, disconnection switch, or electrical outlet. If an electrical accident occurs, you can then quickly remove power from the system.
- Do not work alone when working with high-voltage components.
- Always disconnect power from the system when removing or installing main system components, such as the main board or memory modules. When disconnecting power, first power down the system with the operating system and then unplug the power cords of all the power supply storage systems in the system.
- When working around exposed electrical circuits, ensure that another person who is familiar with the power-off controls is nearby to switch off the power if necessary.
- Use only one hand when working with powered-on electrical equipment. This is to avoid making a complete circuit, which will cause electrical shock. Use extreme caution when

using metal tools, which can easily damage any electrical components or circuit boards they come into contact with.

- Do not use mats designed to decrease static electrical discharge as protection from electrical shock. Instead, use rubber mats that were specifically designed as electrical insulators.
- Use only power supply cords that include a grounding plug and plug them into grounded electrical outlets.

## General Safety Precautions

Follow these rules to ensure general safety:

- Keep the area around the ReadyNAS clean and free of clutter.
- See the technical specifications in this manual for details about your specific ReadyNAS storage systems.
- The ReadyNAS weighs approximately 82 pounds when fully loaded. When lifting the system, two people at either end should lift slowly with their feet spread out to distribute the weight. Always keep your back straight and lift with your legs.
- Place the chassis top cover and any system components that were removed away from the system or on a table so that they will not accidentally be stepped on.
- While working on the system, do not wear loose clothing such as neckties and unbuttoned shirt sleeves, which can come into contact with electrical circuits or be pulled into a cooling fan.
- Remove any jewelry or metal objects from your body, which are excellent metal conductors that can create short circuits and harm you if they come into contact with printed circuit boards or areas where power is present.
- Replace the on-board battery only with the same battery or an equivalent type of battery recommended by the manufacturer. Dispose of used batteries according to the manufacturer's instructions.



### **DANGER:**

**Installing the on-board battery upside down, which reverses its polarities, creates a risk of explosion. Take care to install the battery correctly.**

- Only trained service technicians can replace the self-resetting PTC (positive temperature coefficient) fuses on the main board, using only new fuses that are the same as or equivalent to the ones being replaced. Contact technical support for details and support.

## Electrostatic Discharge Precautions

Electrostatic discharge (ESD) is generated by two objects with different electrical charges coming into contact with each other. An electrical discharge is created to neutralize this difference, which can damage electronic components and printed circuit boards. The following measures are generally sufficient to neutralize this difference before contact is made to protect your equipment from ESD:



- Use a grounded wrist strap designed to prevent static discharge.
- Keep all components and printed circuit boards (PCBs) in their antistatic bags until ready for use.
- Touch a grounded metal object before removing the board from the antistatic bag.
- Do not let components or PCBs come into contact with your clothing, which might retain a charge even if you are wearing a wrist strap.
- Handle a board by its edges only; do not touch its components, peripheral chips, memory modules, or contacts.
- When handling chips or modules, avoid touching their pins.
- Put the main board and peripherals back into their antistatic bags when not in use.
- For grounding purposes, make sure that your computer chassis provides excellent conductivity between the power supply, the case, the mounting fasteners, and the main board.
- After accessing the inside of the system, close the system back up and secure it to the rack unit with the retention screws after ensuring that all connections were made.

## Rack-Mount Precautions

Follow these rack-mount precautions:

- Ensure that the leveling jacks on the bottom of the rack are fully extended to the floor with the full weight of the rack resting on them.
- In single-rack installations, make sure that stabilizers are attached to the rack. In multiple-rack installations, make sure that the racks are coupled together.
- Always make sure that the rack is stable before extending a component from the rack.
- Extend only one component at a time; extending two or more simultaneously might cause the rack to become unstable.
- Determine the placement of each component in the rack *before* you install the rails.
- Install the heaviest components on the bottom of the rack first, and then work up.
- Use a regulating uninterruptible power supply (UPS) to protect the ReadyNAS from power surges and voltage spikes and to keep your system operating in case of a power failure.
- Allow any hot-plug drives and power supply modules to cool before touching them.
- Always keep the rack's front door and all panels and components on the servers closed when not servicing them to maintain proper cooling.