



# User Guide

© Copyright 2017 HP Development Company, L.P.

HDMI, the HDMI Logo and High-Definition Multimedia Interface are trademarks or registered trademarks of HDMI Licensing LLC. Windows is either a registered trademark or trademark of Microsoft Corporation in the United States and/or other countries.

The information contained herein is subject to change without notice. The only warranties for HP products and services are set forth in the express warranty statements accompanying such products and services. Nothing herein should be construed as constituting an additional warranty. HP shall not be liable for technical or editorial errors or omissions contained herein.

**Product notice**

This guide describes features that are common to most models. Some features may not be available on your product. To access the latest user guide, go to <http://www.hp.com/support>. Select **Find your product**, and then follow the on-screen instructions.





First Edition: May 2017

Document Part Number: 928357-001

## About This Guide

This guide provides information on monitor features, setting up the monitor, and technical specifications.

---

-  **WARNING!** Indicates a hazardous situation that, if not avoided, **could** result in death or serious injury.
  -  **CAUTION:** Indicates a hazardous situation that, if not avoided, **could** result in minor or moderate injury.
  -  **IMPORTANT:** Indicates information considered important but not hazard-related (for example, messages related to property damage). A notice alerts the user that failure to follow a procedure exactly as described could result in loss of data or in damage to hardware or software. Also contains essential information to explain a concept or to complete a task.
  -  **NOTE:** Contains additional information to emphasize or supplement important points of the main text.
  -  **TIP:** Provides helpful hints for completing a task.
- 



This product incorporates HDMI technology.



---

# Table of contents

<b>1 Getting started</b>	<b>1</b>
Important safety information	1
Product features and components	2
Features	2
Rear and side components	3
Setting up the monitor	4
Installing the monitor stand	4
Connecting the cables	5
Connecting USB devices	8
Adjusting the monitor	9
Turning on the monitor	11
HP watermark and image retention policy	11
Removing the monitor stand	12
Mounting the display head	12
Installing a security cable	13
<b>2 Using the monitor</b>	<b>14</b>
Software and utilities	14
The Information file	14
The Image Color Matching file	14
Installing the INF and ICM files	14
Installing from the optical disc (available in select regions)	14
Downloading from the web	15
Using the on-screen display (OSD) menu	15
Assigning the Function buttons	16
Selecting a faster response time	17
Selecting the Low Blue Light mode	17
Using Auto-Sleep Mode	18
Factory calibration	18
<b>3 Support and troubleshooting</b>	<b>19</b>
Solving common problems	19
Button lockouts	19
Using the auto-adjustment function (analog input)	20
Optimizing image performance (analog input)	21
Contacting support	22

Preparing to call technical support .....	22
Locating the serial number and product number .....	22
<b>4 Maintaining the monitor .....</b>	<b>23</b>
Maintenance guidelines .....	23
Cleaning the monitor .....	23
Shipping the monitor .....	23
<b>Appendix A Technical specifications .....</b>	<b>24</b>
61.1 cm/24-inch model .....	24
60.5 cm/23.8-inch model .....	25
58.4 cm/23-inch model .....	25
54.6 cm/21.5-inch model .....	26
Preset display resolutions .....	26
61.1 cm/24-inch model .....	27
54.6 cm/21.5-inch, 58.4 cm/23-inch, and 60.5 cm/23.8-inch models .....	27
Entering user modes .....	28
Energy saver feature .....	28
<b>Appendix B Accessibility .....</b>	<b>29</b>
Supported assistive technologies .....	29
Contacting support .....	29

---

# 1 Getting started

## Important safety information

An AC power adapter and cord may be included with the monitor. If another cord is used, use only a power source and connection appropriate for this monitor. For information on the correct power cord set to use with the monitor, refer to the *Product Notices* provided on the optical disc or in your documentation kit.

---

 **WARNING!** To reduce the risk of electric shock or damage to the equipment:

- Plug the power cord into an AC outlet that is easily accessible at all times.
- Disconnect power from the computer by unplugging the power cord from the AC outlet.
- If provided with a 3-pin attachment plug on the power cord, plug the cord into a grounded (earthed) 3-pin outlet. Do not disable the power cord grounding pin, for example, by attaching a 2-pin adapter. The grounding pin is an important safety feature.

For your safety, do not place anything on power cords or cables. Arrange them so that no one may accidentally step on or trip over them.

To reduce the risk of serious injury, read the *Safety & Comfort Guide*. It describes proper workstation setup, and proper posture, health, and work habits for computer users. The *Safety & Comfort Guide* also provides important electrical and mechanical safety information. The *Safety & Comfort Guide* is available on the Web at <http://www.hp.com/ergo>.

 **IMPORTANT:** For the protection of the monitor, as well as the computer, connect all power cords for the computer and its peripheral devices (such as a monitor, printer, scanner) to some form of surge protection device such as a power strip or uninterruptible power supply (UPS). Not all power strips provide surge protection; the power strips must be specifically labeled as having this ability. Use a power strip whose manufacturer offers a damage replacement policy so you can replace the equipment if surge protection fails.

Use the appropriate and correctly sized furniture designed to properly support your HP LCD monitor.

---

 **WARNING!** LCD monitors that are inappropriately situated on dressers, bookcases, shelves, desks, speakers, chests, or carts may fall over and cause personal injury.

Care should be taken to route all cords and cables connected to the LCD monitor so that they cannot be pulled, grabbed, or tripped over.

Be sure that the total ampere rating of the products connected to the AC outlet does not exceed the current rating of the outlet, and that the total ampere rating of the products connected to the cord does not exceed the rating of the cord. Look on the power label to determine the ampere rating (AMPS or A) for each device.

Install the monitor near an AC outlet that you can easily reach. Disconnect the monitor by grasping the plug firmly and pulling it from the AC outlet. Never disconnect the monitor by pulling the cord.

Do not drop the monitor or place it on an unstable surface.

 **NOTE:** This product is suitable for entertainment purposes. Consider placing the monitor in a controlled luminous environment to avoid interference from surrounding light and bright surfaces that may cause disturbing reflections from the screen.

---

# Product features and components

## Features

This guide describes features of the following monitors:

- 54.6 cm (21.5-inch) diagonal viewable screen area with 1920 × 1080 resolution, plus full-screen support for lower resolutions
- 58.4 cm (23-inch) diagonal viewable screen area with 1920 × 1080 resolution, plus full-screen support for lower resolutions
- 60.5 cm (23.8-inch) diagonal viewable screen area with 1920 × 1080 resolution, plus full-screen support for lower resolutions
- 61.1 cm (24-inch) diagonal viewable screen area with 1920 × 1200 resolution, plus full-screen support for lower resolutions

The monitor features include the following:

- Nonglare panel with an LED backlight
- Wide viewing angle to allow viewing from a sitting or standing position, or when moving from side to side
- Tilt, pivot, swivel, and height-adjustment capability
- Removable stand for flexible display head mounting solutions
- Supports an optional mounting bracket for an HP Desktop Mini, Chromebox, or thin client
- Supports an optional HP speaker bar
- DisplayPort video input
- HDMI (High-Definition Multimedia Interface) video input
- VGA video input (cable not included)
- USB 3.0 hub with one upstream port and two downstream ports
- DisplayPort, HDMI, and USB Type-B to Type-A cables included
- Cable management feature for placement of cables and cords
- HDCP (High-Bandwidth Digital Content Protection) copy protection on all digital inputs
- Plug and Play capability if supported by your operating system
- Security cable slot provision on rear of monitor for optional security cable
- On-screen display (OSD) adjustments in several languages for easy setup and screen optimization
- HP Display Assistant software for adjusting monitor settings and enabling the theft deterrence features
- Software and documentation disc provided with the monitor in select regions that includes monitor drivers and product documentation
- Energy saver feature to meet requirements for reduced power consumption



**NOTE:** For safety and regulatory information, refer to the *Product Notices* provided in your documentation kit. To locate updates to the user guide for your product, go to <http://www.hp.com/support>. Select **Find your product**, and then follow the on-screen instructions.



## Rear and side components

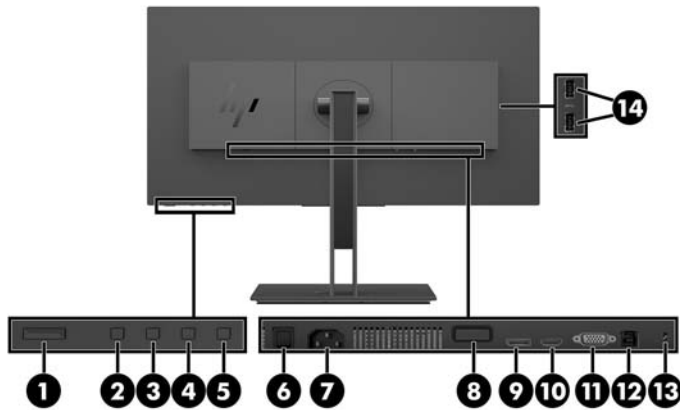

	Component	Description
(1)	Power button	Turns the monitor on or off.
(2)	Back/Exit button	If the OSD is open, press to go back or exit the OSD. If the OSD menu is closed, press to switch to the next active input.
(3)	Plus button	If the OSD menu is open, press to navigate forward through the OSD menu and increase adjustment levels. If the OSD menu is closed, press to open the Viewing Modes menu.
(4)	Minus button	If the OSD menu is open, press to navigate backward through the OSD menu and decrease adjustment levels. If the OSD menu is closed, press to open the Color menu.
(5)	Menu button	Press to open the OSD menu, select a menu item from the OSD, or close the OSD menu.
(6)	Master power switch	Turns off all power to the monitor. Putting the switch in the off position will yield the lowest power state for the monitor when it is not in use.
(7)	Power connector	Connects the AC power cord to the monitor.
(8)	Monitor release button	Disengages the monitor stand from the display head.
(9)	DisplayPort port	Connects the DisplayPort cable to the source device.
(10)	HDMI port	Connects the HDMI cable to the source device.
(11)	VGA port	Connects a VGA cable to the source device.
(12)	USB 3.0 Type-B port	Connects the USB hub cable to the source device.
(13)	Security cable slot	Connects an optional security cable.
(14)	USB 3.0 Type-A ports (2)	Connect USB devices.

# Setting up the monitor

## Installing the monitor stand

 **IMPORTANT:** Do not touch the surface of the LCD panel. Pressure on the panel may cause nonuniformity of color or disorientation of the liquid crystals. If this occurs, the screen will not recover to its normal condition.

1. Position the monitor facedown on a flat surface covered by a soft clean cloth.
2. Slide the tabs on the top of the stand's mounting bracket into the slots on the display head (1), and then press the bottom of the bracket down (2). There will be an audible click when the stand is properly seated. Make sure that the stand is properly attached to the display head before use.

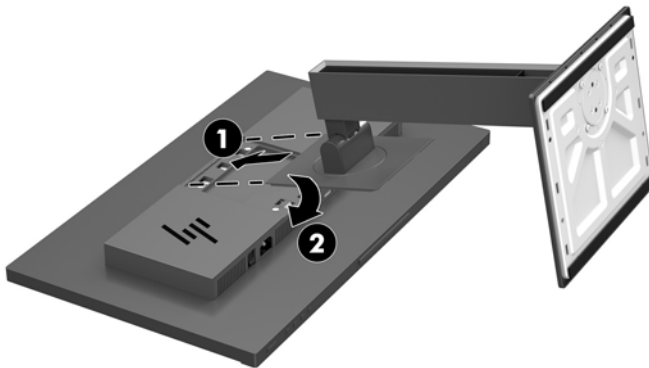

## Connecting the cables

 **NOTE:** The monitor ships with select cables. Not all cables shown in this section are included with the monitor.

1. Place the monitor in a convenient, well-ventilated location near the computer.
2. Before connecting the cables, route the cables through the cable routing hole in the center of the stand.

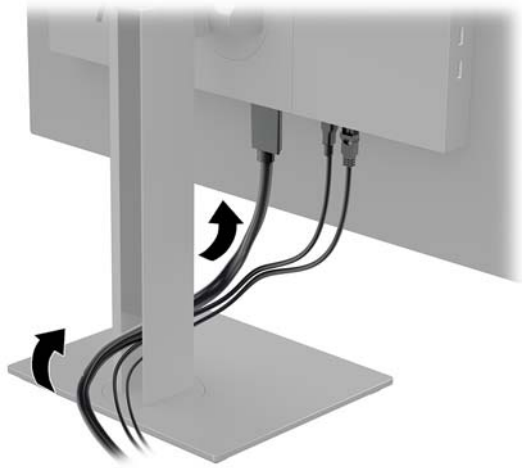

3. Connect a video cable.

 **NOTE:** The monitor automatically determines which inputs have valid video signals. The inputs can be selected by pressing the **Menu** button to access the on-screen display (OSD) menu and then selecting **Input Control**.

- Connect one end of a DisplayPort cable to the DisplayPort port on the rear of the monitor and the other end to the DisplayPort port on the source device.

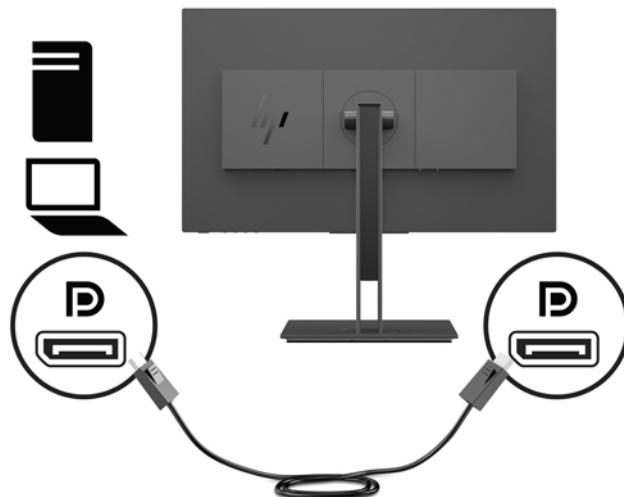

- Connect one end of an HDMI cable to the HDMI port on the rear of the monitor and the other end to the HDMI port on the source device.

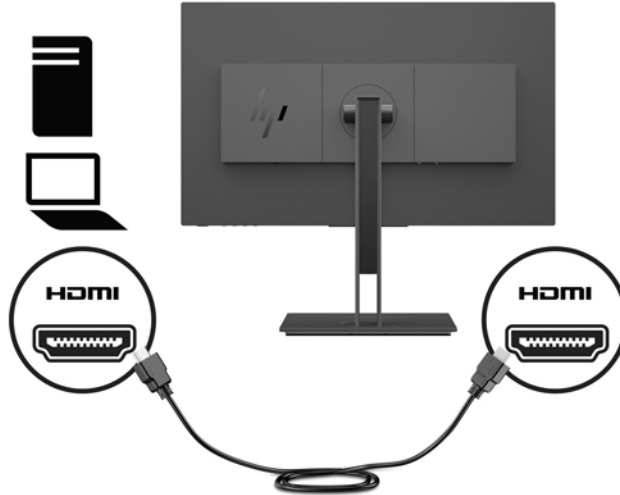

- Connect one end of a VGA cable to the VGA port on the rear of the monitor and the other end to the VGA port on the source device.

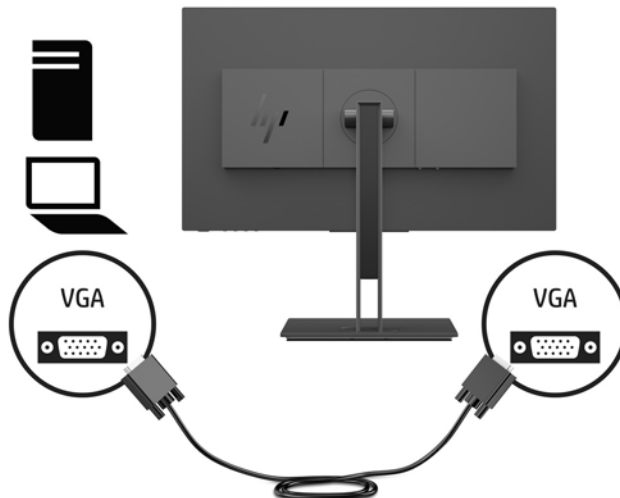

4. Connect the Type-B connector of the USB upstream cable to the USB upstream port on the rear of the monitor. Then connect the cable's Type-A connector to a USB downstream port on the source device.

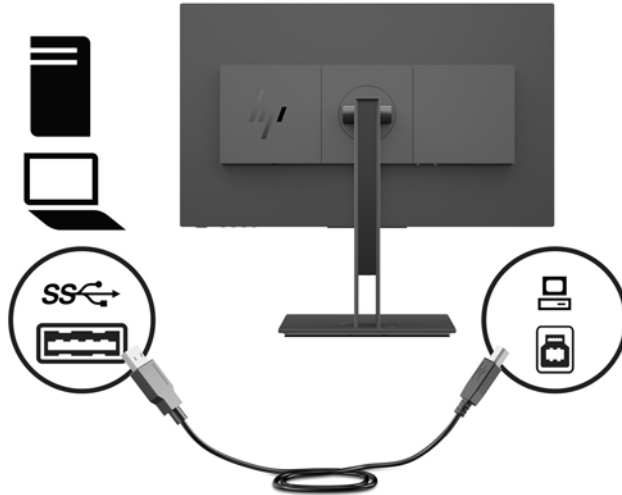

5. Connect one end of the power cord to the power connector on the rear of the monitor and the other end to a grounded AC outlet.

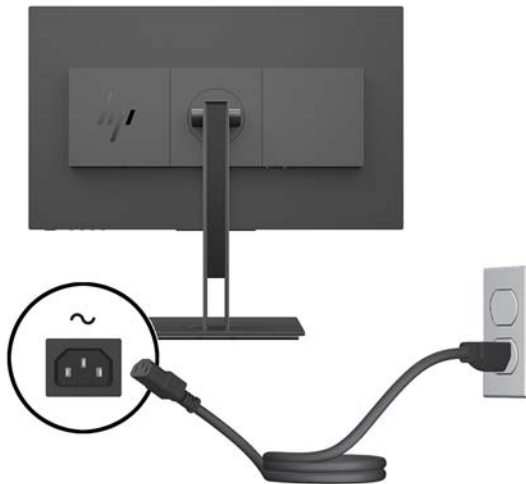

---

**⚠ WARNING!** To reduce the risk of electric shock or damage to the equipment:

Do not disable the power cord grounding plug. The grounding plug is an important safety feature.

Plug the power cord into a grounded (earthed) AC outlet that is easily accessible at all times.

Disconnect power from the equipment by unplugging the power cord from the AC outlet.

For your safety, do not place anything on power cords or cables. Arrange them so that no one may accidentally step on or trip over them. Do not pull on a cord or cable. When unplugging the power cord from the AC outlet, grasp the cord by the plug.

---

## Connecting USB devices

The rear of the monitor provides one USB Type-B upstream port. There are two USB Type-A downstream ports on the side of the monitor.

 **NOTE:** You must connect the USB upstream cable from the source device to the monitor to enable the USB downstream ports on the monitor.

---

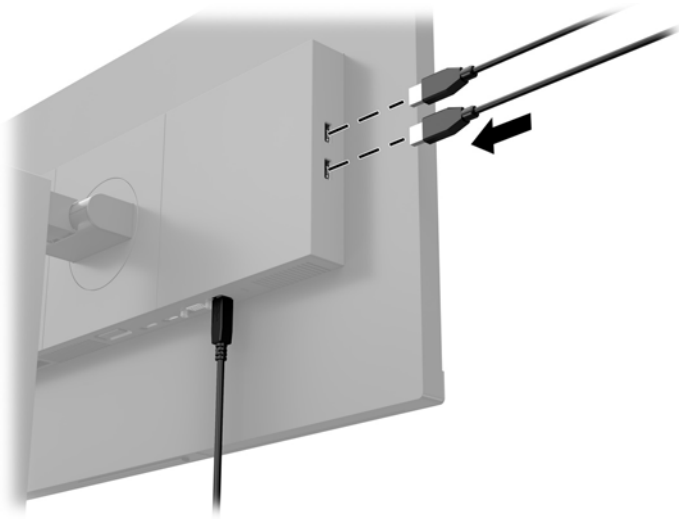

## Adjusting the monitor

1. Tilt the display head forward or backward to set it to a comfortable eye level.

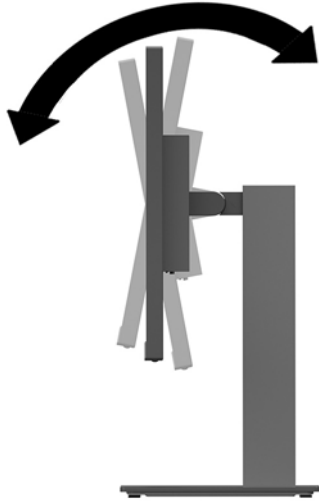

2. Swivel the display head to the left or right for the best viewing angle.

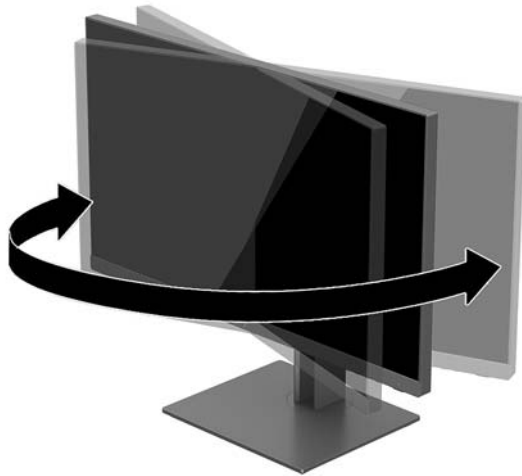

3. Adjust the display head up or down to set it to a comfortable eye level.

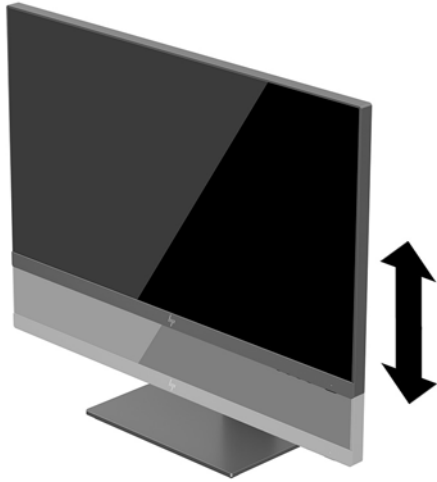

4. You can pivot the monitor from landscape to portrait orientation viewing to adapt to your application.
  - a. Adjust the monitor to full height position and tilt the monitor back to full tilt position (1).
  - b. Pivot the monitor clockwise 90° or counterclockwise 90° from landscape to portrait orientation (2).

 **IMPORTANT:** If the monitor is not in full height and full tilt position when pivoting, the bottom right corner of the monitor panel will come in contact with the base and potentially cause damage to the monitor.

---

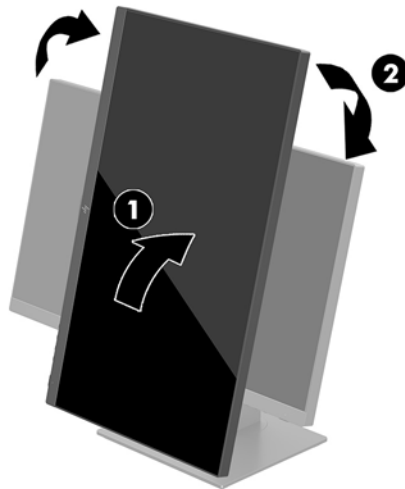

 **NOTE:** To view information on the screen in portrait mode, you can install the HP Display Assistant software included on the software and documentation disc. The position of the OSD menu can also be rotated to portrait mode. To rotate the OSD menu, press the [Menu](#) button to open the OSD, and then select **Menu Control**. Select **Menu Rotation**, and then select the appropriate rotation choice for your application.

---



## Turning on the monitor

1. Set the master power switch on the rear of the monitor to the On position.
2. Press the power button on the computer to turn it on.
3. Press the power button on the bottom of the monitor to turn it on.



---

**IMPORTANT:** Burn-in image damage may occur on monitors that display the same static image on the screen for 12 or more consecutive hours of nonuse. To avoid burn-in image damage on the monitor screen, you should always activate a screen saver application or turn off the monitor when it is not in use for a prolonged period of time. Image retention is a condition that may occur on all LCD screens. Monitors with a "burned-in image" are not covered under the HP warranty.

**NOTE:** If pressing the power button has no effect, the Power Button Lockout feature may be enabled. To disable this feature, press and hold the monitor power button for 10 seconds.

**NOTE:** You can disable the power LED in the OSD menu. Press the **Menu** button to open the OSD, and then select **Power Control**. Select **Power LED**, and then select **Off**.

---

The monitor automatically scans the signal inputs for an active input and uses that input for the screen.

## HP watermark and image retention policy

The IPS monitor models are designed with IPS (In-Plane Switching) display technology which provides ultra-wide viewing angles and advanced image quality. IPS monitors are suitable for a wide variety of advanced image quality applications. This panel technology, however, is not suitable for applications that exhibit static, stationary, or fixed images for long periods of time without the use of screen savers. These types of applications may include camera surveillance, video games, marketing logos, and templates that are displayed on the screen for a prolonged period of time. Static images may cause image retention damage that could look like stains or watermarks on the monitor's screen.

Monitors in use for 24 hours per day that result in image retention damage are not covered under the HP warranty. To avoid image retention damage, always turn off the monitor when it is not in use or use the power management setting, if supported on your system, to turn off the display when the system is idle.

## Removing the monitor stand

You can remove the display head from the stand to install the display head on a wall, a swing arm, or other mounting fixture.

 **IMPORTANT:** Before beginning to disassemble the monitor, be sure the monitor is turned off and all cables are disconnected.

1. Disconnect and remove all cables from the monitor.
2. Position the monitor facedown on a flat surface covered by a soft clean cloth.
3. Press the release button on the rear of the display head (1), and then lift the bottom of the stand up (2) and slide the stand back (3) to remove it.

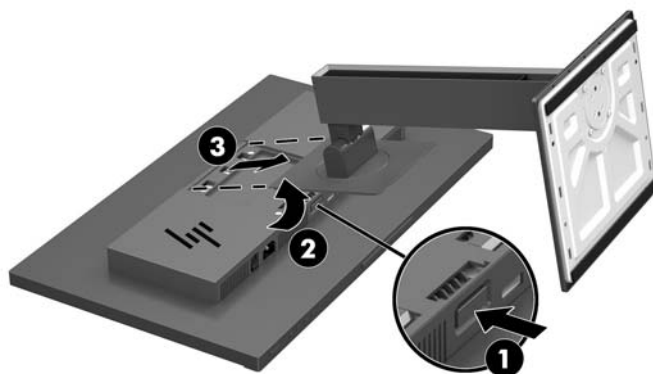

## Mounting the display head

The display head can be attached to a wall, swing arm, or other mounting fixture.

 **NOTE:** This apparatus is intended to be supported by a UL or CSA Listed wall-mount bracket.

 **IMPORTANT:** This VESA mount kit supports the VESA industry-standard 100 mm mounting holes. To attach a third-party mounting solution to the VESA mount, use four 4 mm, 0.7 pitch, 10 mm-long screws. Longer screws must not be used because they may damage the monitor. It is important to verify that the manufacturer's mounting solution is compliant with the VESA standard and is rated to support the weight of the monitor display panel. For best performance, it is important to use the power and video cables provided with the monitor.

1. Remove the monitor stand if it is attached to the display head. Refer to [Removing the monitor stand on page 12](#).

2. To attach the display head to a swing arm or other mounting device, insert four mounting screws through the holes on the mounting device and into the VESA screw holes on the display head.

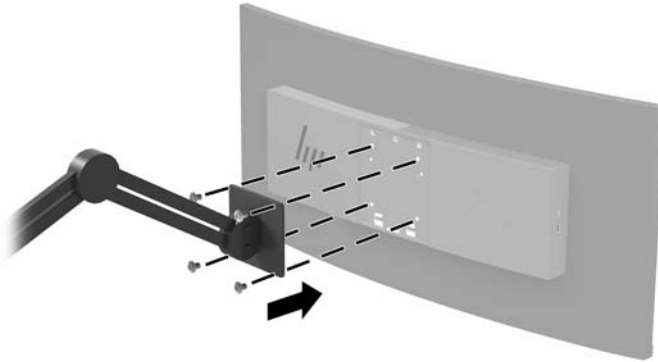

 **IMPORTANT:** Follow the mounting device manufacturer's instructions when mounting the monitor to a wall or swing arm.

## Installing a security cable

You can secure the monitor to a fixed object with an optional security cable available from HP.



---

## 2 Using the monitor

### Software and utilities

The optical disc, if one is included with the monitor, contains the following files you can install on the computer. If you do not have an optical drive, you can download the files from <http://www.hp.com/support>.

- INF (Information) file
- ICM (Image Color Matching) files (one for each calibrated color space)

### The Information file

The INF file defines monitor resources used by Windows® operating systems to ensure monitor compatibility with the computer's graphics adapter.

This monitor is Windows Plug and Play-compatible and the monitor will work correctly without installing the INF file. Monitor Plug and Play compatibility requires that the computer's graphic card is VESA DDC2-compliant and that the monitor connects directly to the graphics card. Plug and Play does not work through separate BNC type connectors or through distribution buffers/boxes.

### The Image Color Matching file

The ICM files are data files that are used in conjunction with graphics programs to provide consistent color matching from monitor screen to printer, or from scanner to monitor screen. This file is activated from within graphics programs that support this feature.



---

**NOTE:** The ICM color profile is written in accordance with the International Color Consortium (ICC) Profile Format specification.

---

## Installing the INF and ICM files

After you determine that you need to update, use one of the following methods to install the files.

### Installing from the optical disc (available in select regions)

1. Insert the optical disc into the computer optical drive. The optical disc menu is displayed.
2. View the **HP Monitor Software Information** file.
3. Select **Install Monitor Driver Software**.
4. Follow the on-screen instructions.
5. Ensure that the proper resolution and refresh rates appear in the Windows Display control panel.

## Downloading from the web

If you do not have a computer or source device with an optical drive, you can download the latest versions of INF and ICM files from the HP monitors support website.

1. Go to <http://www.hp.com/support>.
2. Select **Get software and drivers**.
3. Follow the on-screen instructions to select your monitor and download the software.

## Using the on-screen display (OSD) menu

Use the on-screen display (OSD) menu to adjust the screen image based on your viewing preferences. You can access and make adjustments in the OSD using the buttons on the bottom of the monitor.

To access the OSD and make adjustments, do the following:

1. If the monitor is not already on, press the power button to turn on the monitor.
2. To access the OSD menu, press the **Menu** button on the bottom of the monitor.
3. To navigate through the OSD menu, press the **Plus** button on the bottom of the monitor to scroll up, or the **Minus** button to scroll down.
4. To select an item from the OSD menu, use the **Plus** or **Minus** buttons to scroll to and highlight your selection, and then press the **Menu** button to select that function.
5. Adjust the item using the **Plus** or **Minus** buttons to adjust the scale.
6. After adjusting the function, select **OK** to save the setting, and then select **Exit** from the main menu.

Main menu	Description
Brightness	Adjusts the brightness level of the screen.
Contrast	Adjusts the screen contrast.
Color Control	Selects and adjusts the screen color and viewing modes.
Input Control	Selects the video input signal (DisplayPort, HDMI, or VGA).
Image Control	Adjusts the screen image and response time.
Power Control	Adjusts the power settings.
Menu Control	Adjusts the on-screen display (OSD) controls.
Management	Returns all OSD menu settings to the factory default settings.
Language	Selects the language in which the OSD menu is displayed.
Information	Selects and displays important information about the monitor.
Exit	Exits the OSD menu screen.

## Assigning the Function buttons

Pressing one of the four OSD bezel buttons activates the buttons and displays icons above the buttons. The default button icons and functions are shown below.

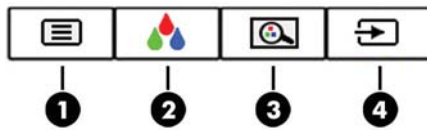

Button	Function
1 Menu	Opens the OSD main menu.
2 Color Control (Function button 3 - assignable)	Opens the Color menu.
3 Viewing Modes (Function button 2 - assignable)	Opens the Viewing Modes menu.
4 Next Active Input (Function button 1 - assignable)	Switches the monitor's input source to the next active input.

You can change the Function buttons from their default values so that when the buttons are activated you can quickly access commonly used menu items.

To assign the Function buttons:

1. Press the **Menu** button to open the OSD.
2. In the OSD menu, select **Menu Control**, select **Assign Buttons**, and then select one of the available options for the button you want to assign.



**NOTE:** You can only assign the three Function buttons. You can not reassign the **Menu** button or the power button.

## Selecting a faster response time

1. Press the **Menu** button to open the OSD.
2. Select **Image Control** and then select **Response Time**.
3. Select one of the following levels from the **Response Time** menu:
  - Level 1 (Default)
  - Level 2 (Fast)
  - Level 3
  - Level 4
  - Level 5 (Fastest)



**NOTE:** The default response time is 14.0 ms. The response time can be adjusted to as fast as 5.4 ms in the display menu. All performance specifications represent the typical specifications provided by HP's component manufacturers; actual performance may vary either higher or lower.

## Selecting the Low Blue Light mode

Decreasing the blue light emitted by the display reduces the blue light exposure to your eyes. HP monitors provide settings to reduce the blue light output and create a more relaxing and less stimulating image while you view content on the screen. To adjust your monitor to a comfortable viewing light, follow the steps below.

1. Press one of the four OSD bezel buttons on the bottom of the monitor to display the OSD icons on the screen.
2. Press the **Viewing Modes** button to open the Viewing Modes menu, or press the **Menu** button, select **Color Control**, and then select **Viewing Modes**.
3. Choose one of the following settings:
  - Low Blue Light (TUV certified): Reduces blue light for improved eye comfort
  - Reading: Optimizes both blue light and brightness for indoor viewing
  - Night: Adjusts the monitor to the lowest blue light output



**WARNING!** To reduce the risk of serious injury, read the *Safety & Comfort Guide*. It describes proper workstation setup, and proper posture, health, and work habits for computer users. The *Safety & Comfort Guide* also provides important electrical and mechanical safety information. The *Safety & Comfort Guide* is available on the Web at <http://www.hp.com/ergo>.

## Using Auto-Sleep Mode

The monitor supports an OSD (on-screen display) menu option called Auto-Sleep Mode that allows you to enable or disable a reduced power state for the monitor. When Auto-Sleep Mode is enabled (enabled by default), the monitor will enter a reduced power state when the host computer signals low power mode (absence of either horizontal or vertical sync signal).

Upon entering this reduced power state (sleep mode), the monitor screen is blanked, the backlight is turned off, and the power LED indicator turns amber. The monitor draws less than 0.5 W of power when in this reduced power state. The monitor will wake from the sleep mode when the host device sends an active signal to the monitor (for example, if you activate the mouse or keyboard).

You can disable Auto-Sleep Mode in the OSD. Press the **Menu** button to open the OSD, and then select **Power Control**, select **Auto-Sleep Mode**, and then select **Off**.

## Factory calibration

The following color spaces are precalibrated at the factory:

- sRGB
- BT.709

The following color spaces are also available and are not precalibrated at the factory:

- Warm
- Neutral
- Cool
- Viewing Modes
- Custom RGB



# 3 Support and troubleshooting

## Solving common problems

The following table lists possible problems, the possible cause of each problem, and the recommended solutions.

Problem	Possible Cause	Solution
Screen is blank or video is flashing.	Power cord is disconnected.	Connect the monitor power cord.
	Monitor is off.	Set the master power switch to the On position. Press the monitor power button. <b>NOTE:</b> If pressing the power button has no effect, press and hold the power button for 10 seconds to disable the Power Button Lockout feature.
	Video cable is not connected.	Connect the video cable between the source device and monitor. Be sure the computer power is off while you connect the video cable. Refer to <a href="#">Connecting the cables on page 5</a> for more information.
	System is in sleep mode.	Press any key on the keyboard or move the mouse to exit sleep mode.
	Video card is incompatible.	Replace the video card or connect the video cable to one of the computer's onboard video sources.
Image appears too dark.	Brightness setting is too low.	Open the OSD menu and select <b>Brightness</b> to adjust the brightness scale as needed.
<b>Input Signal Not Found</b> is displayed on screen.	Monitor video cable is disconnected.	Connect the appropriate video signal cable between the computer and monitor. Be sure that the computer power is off while connecting the video cable.
<b>Input Signal Out of Range</b> is displayed on screen.	Video resolution and/or refresh rate are set higher than the monitor supports.	Change the settings to a supported setting (see <a href="#">Preset display resolutions on page 26</a> ).
The monitor is off but it did not seem to enter a low-power sleep mode.	The monitor's sleep mode is disabled.	Open the OSD menu and select <b>Power Control</b> , select <b>Auto-Sleep Mode</b> , and then set auto-sleep to <b>On</b> .
<b>OSD Lockout</b> is displayed.	The monitor's OSD Lockout function is enabled.	Press and hold the <b>Menu</b> button for 10 seconds to disable the OSD Lockout function.
<b>Power Button Lockout</b> is displayed.	The monitor's Power Button Lockout function is enabled.	Press and hold the power button for 10 seconds to disable the Power Button Lockout function.

## Button lockouts

Holding down the power button or **Menu** button for ten seconds will lock out the functionality of that button. You can restore the functionality by holding the button down again for ten seconds. This functionality is only available when the monitor is powered on, displaying an active signal, and the OSD is not active.

## Using the auto-adjustment function (analog input)

When you first set up the monitor, conduct a factory reset of the computer, or change the resolution of the monitor, the auto-adjustment feature automatically engages and attempts to optimize your screen for you.

You may also optimize the screen performance for the VGA (analog) input at any time by using the Auto-Adjustment setting in the OSD and the auto-adjustment pattern software utility on the optical disc provided (select products only).

Do not use this procedure if the monitor is using an input other than VGA. If the monitor is using a VGA (analog) input, this procedure can correct the following image quality conditions:

- Fuzzy or unclear focus
- Ghosting, streaking, or shadowing effects
- Faint vertical bars
- Thin, horizontal scrolling lines
- An off-center picture

To use the auto-adjustment feature:

1. Allow the monitor to warm up for 20 minutes before adjusting.
2. Press the **Menu** button to open the OSD, select **Image Control**, and then select **Auto-Adjustment** from the OSD menu. If the result is not satisfactory, continue with the procedure.
3. Insert the optical disc into the optical drive. The optical disc menu is displayed.
4. Select **Open Auto-Adjustment Utility**. The setup test pattern is displayed.

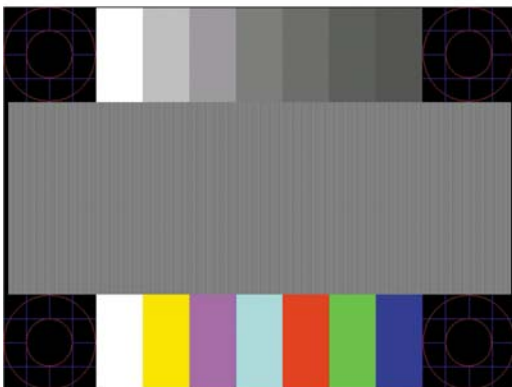

5. Press the **Menu** button to open the OSD, select **Image Control**, and then select **Auto-Adjustment** from the OSD menu. to produce a stable, centered image.
6. Press the **ESC** key or any other key on the keyboard to exit the test pattern.



**NOTE:** The auto-adjustment test pattern utility can be downloaded from <http://www.hp.com/support>.

## Optimizing image performance (analog input)

Two controls in the on-screen display can be adjusted to improve image performance: Clock and Phase (available in the OSD menu).

 **NOTE:** The Clock and Phase controls are adjustable only when using an analog (VGA) input. These controls are not adjustable for digital inputs.

The Clock must first be set correctly since the Phase settings are dependent on the main Clock setting. Use these controls only when the auto-adjustment function does not provide a satisfactory image.

- **Clock:** Increases/decreases the value to minimize any vertical bars or stripes visible on the screen background.
- **Phase:** Increases/decreases the value to minimize video flickering or blurring.

 **NOTE:** When using the controls, you will obtain the best results by using the auto-adjustment pattern software utility provided on the optical disc.

When adjusting the Clock and Phase values, if the monitor images become distorted, continue adjusting the values until the distortion disappears. To restore the factory settings, select **Yes** from the **Factory Reset** menu in the on-screen display.

To eliminate vertical bars (Clock):

1. Press the **Menu** button to open the OSD menu, select **Image Control**, and then select **Clock and Phase**.
2. Use the OSD buttons on the monitor to eliminate vertical bars. Press the buttons slowly so that you do not miss the optimum adjustment point.

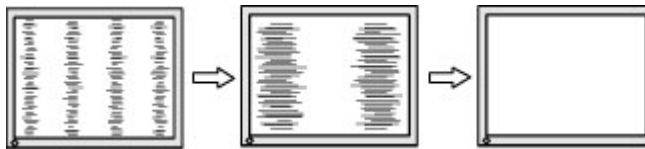

3. After adjusting the Clock, if blurring, flickering, or bars appear on the screen, proceed to adjust the Phase.

To remove flickering or blurring (Phase):

1. Press the **Menu** button to open the OSD menu, select **Image Control**, and then select **Clock and Phase**.
2. Press the OSD buttons on the monitor to eliminate flickering or blurring. Flickering or blurring may not be eliminated, depending on the computer or graphics controller card installed.



To correct screen position (Horizontal Position or Vertical Position):

1. Press the **Menu** button to open the OSD menu, select **Image Control**, and then select **Image Position**.

2. Press the OSD buttons on the monitor to properly adjust the position of the image in the display area of the monitor. The Horizontal Position shifts the image left or right; the Vertical Position shifts the image up and down.

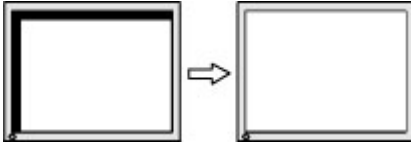

## Contacting support

To resolve a hardware or software problem, go to <http://www.hp.com/support>. Use this site to get more information about your product, including links to discussion forums and instructions on troubleshooting. You can also find information on how to contact HP and open a support case.

## Preparing to call technical support

If you cannot solve a problem using the troubleshooting tips in this section, you may need to call technical support. Have the following information available when you call:

- Monitor model number
- Monitor serial number
- Purchase date on invoice
- Conditions under which the problem occurred
- Error messages received
- Hardware configuration
- Name and version of the hardware and software you are using

## Locating the serial number and product number

The serial number and product number are located on a label on the bottom edge of the display head. You may need these numbers when contacting HP about the monitor model.



---

# 4 Maintaining the monitor

## Maintenance guidelines

To enhance the performance and extend the life of the monitor:

- Do not open the monitor cabinet or attempt to service this product yourself. Adjust only those controls that are covered in the operating instructions. If the monitor is not operating properly or has been dropped or damaged, contact an authorized HP dealer, reseller, or service provider.
- Use only a power source and connection appropriate for this monitor, as indicated on the label/back plate of the monitor.
- Be sure the total ampere rating of the products connected to the outlet does not exceed the current rating of the electrical outlet, and the total ampere rating of the products connected to the cord does not exceed the rating of the cord. Look on the power label to determine the ampere rating (AMPS or A) for each device.
- Install the monitor near an outlet that you can easily reach. Disconnect the monitor by grasping the plug firmly and pulling it from the outlet. Never disconnect the monitor by pulling the cord.
- Turn the monitor off when not in use. You can substantially increase the life expectancy of the monitor by using a screen saver program and turning off the monitor when not in use.



**NOTE:** Monitors with a “burned-in image” are not covered under the HP warranty.

- Slots and openings in the cabinet are provided for ventilation. These openings must not be blocked or covered. Never push objects of any kind into cabinet slots or other openings.
- Do not drop the monitor or place it on an unstable surface.
- Do not allow anything to rest on the power cord. Do not walk on the cord.
- Keep the monitor in a well-ventilated area, away from excessive light, heat or moisture.

## Cleaning the monitor

1. Turn off the monitor and unplug the power cord from the AC outlet.
2. Dust the monitor by wiping the screen and the cabinet with a soft, clean antistatic cloth.
3. For more difficult cleaning situations, use a 50/50 mix of water and Isopropyl alcohol.



**IMPORTANT:** Spray the cleaner onto a cloth and use the damp cloth to gently wipe the screen surface. Never spray the cleaner directly on the screen surface. It may run behind the bezel and damage the electronics.

**IMPORTANT:** Do not use cleaners that contain any petroleum-based materials such as benzene, thinner, or any volatile substance to clean the monitor screen or cabinet. These chemicals may damage the monitor.

---

## Shipping the monitor

Keep the original packing box in a storage area. You may need it later if you move or ship the monitor.

# A Technical specifications



**NOTE:** All specifications represent the typical specifications provided by HP's component manufacturers; actual performance may vary either higher or lower.

For the latest specifications or additional specifications on this product, go to <http://www.hp.com/go/quickspecs/> and search for your specific monitor model to find the model-specific QuickSpecs.

## 61.1 cm/24-inch model

Specification	Measurement	
<b>Display</b>	<b>61.1 cm</b> wide screen	24-inch wide screen
<b>Type</b>	IPS LCD	
<b>Viewable image size</b>	<b>61.1 cm</b> diagonal	24-inch diagonal
<b>Maximum weight (unpacked)</b>	<b>6.6 kg</b>	14.6 lb
<b>Dimensions (include base)</b>		
Height	<b>50.3 cm</b>	19.8 inches
Depth	<b>21.4 cm</b>	8.4 inches
Width	<b>53.2 cm</b>	20.9 inches
<b>Maximum graphic resolution</b>	1920 × 1200 @ 75 Hz	
<b>Optimum graphic resolution</b>	1920 × 1200 @ 60 Hz	
<b>Environmental requirements temperature</b>		
Operating temperature	<b>5°C to 35°C</b>	41°F to 95°F
Storage temperature	<b>-20°C to 60°C</b>	-4°F to 140°F
Operating humidity	20% to 80% RH (non-condensing)	
Non-operating humidity	5% to 95% RH (non-condensing)	
<b>Power source</b>	100–240 V ac 50/60 Hz	
<b>Input terminal</b>	One DisplayPort port, one HDMI port, and one VGA port	

## 60.5 cm/23.8-inch model

Specification	Measurement	
<b>Display</b>	<b>60.5 cm</b> wide screen	23.8-inch wide screen
<b>Type</b>	IPS LCD	
<b>Viewable image size</b>	<b>60.5 cm</b> diagonal	23.8-inch diagonal
<b>Maximum weight (unpacked)</b>	<b>5.6 kg</b>	12.4 lb
<b>Dimensions (include base)</b>		
Height	<b>46.3 cm</b>	18.22 inches
Depth	<b>20.5 cm</b>	8.07 inches
Width	<b>53.88 cm</b>	21.2 inches
<b>Maximum graphic resolution</b>	1920 × 1080 @ 75 Hz	
<b>Optimum graphic resolution</b>	1920 × 1080 @ 60 Hz	
<b>Environmental requirements temperature</b>		
Operating temperature	<b>5°C to 35°C</b>	41°F to 95°F
Storage temperature	<b>-20°C to 60°C</b>	-4°F to 140°F
Operating humidity	20% to 80% RH (non-condensing)	
Non-operating humidity	5% to 95% RH (non-condensing)	
<b>Power source</b>	100–240 V ac 50/60 Hz	
<b>Input terminal</b>	One DisplayPort port, one HDMI port, and one VGA port	

## 58.4 cm/23-inch model

Specification	Measurement	
<b>Display</b>	<b>58.4 cm</b> wide screen	23-inch wide screen
<b>Type</b>	IPS LCD	
<b>Viewable image size</b>	<b>58.4 cm</b> diagonal	23-inch diagonal
<b>Maximum weight (unpacked)</b>	<b>5.9 kg</b>	13.0 lb
<b>Dimensions (include base)</b>		
Height	<b>45.8 cm</b>	18.0 inches
Depth	<b>20.5 cm</b>	8.07 inches
Width	<b>52.1 cm</b>	20.5 inches
<b>Maximum graphic resolution</b>	1920 × 1080 @ 75 Hz	
<b>Optimum graphic resolution</b>	1920 × 1080 @ 60 Hz	
<b>Environmental requirements temperature</b>		

Specification	Measurement	
Operating temperature	<b>5°C to 35°C</b>	41°F to 95°F
Storage temperature	<b>-20°C to 60°C</b>	-4°F to 140°F
Operating humidity	20% to 80% RH (non-condensing)	
Non-operating humidity	5% to 95% RH (non-condensing)	
<b>Power source</b>	100–240 V ac 50/60 Hz	
<b>Input terminal</b>	One DisplayPort port, one HDMI port, and one VGA port	

## 54.6 cm/21.5-inch model

Specification	Measurement	
<b>Display</b>	<b>54.6 cm</b> wide screen	21.5-inch wide screen
<b>Type</b>	IPS LCD	
<b>Viewable image size</b>	<b>54.6 cm</b> diagonal	21.5-inch diagonal
<b>Maximum weight (unpacked)</b>	<b>5.3 kg</b>	11.7 lb
<b>Dimensions (include base)</b>		
Height	<b>44.87 cm</b>	17.7 inches
Depth	<b>20.5 cm</b>	8.07 inches
Width	<b>48.83 cm</b>	19.22 inches
<b>Maximum graphic resolution</b>	1920 × 1080 @ 75 Hz	
<b>Optimum graphic resolution</b>	1920 × 1080 @ 60 Hz	
<b>Environmental requirements temperature</b>		
Operating temperature	<b>5°C to 35°C</b>	41°F to 95°F
Storage temperature	<b>-20°C to 60°C</b>	-4°F to 140°F
Operating humidity	20% to 80% RH (non-condensing)	
Non-operating humidity	5% to 95% RH (non-condensing)	
<b>Power source</b>	100–240 V ac 50/60 Hz	
<b>Input terminal</b>	One DisplayPort port, one HDMI port, and one VGA port	

## Preset display resolutions

The display resolutions listed below are the most commonly used modes and are set as factory defaults. The monitor automatically recognizes these preset modes and they will appear properly sized and centered on the screen.



## 61.1 cm/24-inch model

 **IMPORTANT:** The monitor can support up to 75 Hz refresh for some video modes. However, the video card of the connected source device must be capable of supporting 75 Hz. The preferred mode is 1920 x 1200 @ 60 Hz.

---

### Preset display resolutions

---

640 × 480 @ 60 Hz, 75 Hz

---

720 × 400 @ 70 Hz

---

800 × 600 @ 60 Hz, 75 Hz

---

1024 × 768 @ 60 Hz, 75 Hz

---

1280 × 720 @ 60 Hz

---

1280 × 800 @ 60 Hz

---

1280 × 1024 @ 60 Hz, 75 Hz

---

1440 × 900 @ 60 Hz

---

1600 × 900 @ 60 Hz

---

1680 × 1050 @ 60 Hz

---

1920 × 1080 @ 60 Hz

---

1920 × 1200 @ 60 Hz, 75 Hz

---

## 54.6 cm/21.5-inch, 58.4 cm/23-inch, and 60.5 cm/23.8-inch models

 **IMPORTANT:** The monitors can support up to 75 Hz refresh for some video modes. However, the video card of the connected source device must be capable of supporting 75 Hz. The preferred mode is 1920 x 1080 @ 60 Hz.

---

### Preset display resolutions

---

640 × 480 @ 60 Hz, 75 Hz

---

720 × 400 @ 70 Hz

---

800 × 600 @ 60 Hz, 75 Hz

---

1024 × 768 @ 60 Hz, 75 Hz

---

1280 × 720 @ 60 Hz

---

1280 × 800 @ 60 Hz

---

1280 × 1024 @ 60 Hz, 75 Hz

---

1440 × 900 @ 60 Hz

---

1600 × 900 @ 60 Hz

---

1680 × 1050 @ 60 Hz

---

1920 × 1080 @ 60 Hz, 75 Hz

---

## Entering user modes

Under the following conditions, the video controller signal may occasionally call for a mode that is not preset:

- You are not using a standard graphics adapter.
- You are not using a preset mode.

If this occurs, you may need to readjust the parameters of the monitor screen by using the on-screen display. Your changes can be made to any or all of these modes and saved in memory. The monitor automatically stores the new setting and then recognizes the new mode just as it does a preset mode. In addition to the factory preset modes, there are at least 10 user modes that can be entered and stored.

## Energy saver feature

The monitors support a reduced power state. The reduced power state will be initiated if the monitor detects the absence of either the horizontal sync signal or the vertical sync signal. Upon detecting the absence of these signals, the monitor screen is blanked, the backlight is turned off, and the power light turns amber. When the monitor is in the reduced power state, the monitor will utilize 0.5 watts of power. There is a brief warm-up period before the monitor returns to its normal operating mode.

Refer to the computer manual for instructions on setting energy saver features (sometimes called power management features).



---

**NOTE:** The energy saver feature only works when the monitor is connected to a computer that has energy saver features.

---

By selecting the settings in the monitor's Energy Saver utility, you can also program the monitor to initiate the reduced power state at a predetermined time. When the monitor's Energy Saver utility causes the monitor to initiate the reduced power state, the power light blinks amber.

---

## B Accessibility

HP designs, produces, and markets products and services that can be used by everyone, including people with disabilities, either on a stand-alone basis or with appropriate assistive devices.

### Supported assistive technologies

HP products support a wide variety of operating system assistive technologies and can be configured to work with additional assistive technologies. Use the Search feature on your source device that is connected to the monitor to locate more information about assistive features.

---

 **NOTE:** For additional information about a particular assistive technology product, contact customer support for that product.

---

### Contacting support

We are constantly refining the accessibility of our products and services and welcome feedback from users. If you have an issue with a product or would like to tell us about accessibility features that have helped you, please contact us at (888) 259-5707, Monday through Friday, 6 a.m. to 9 p.m. Mountain Time. If you are deaf or hard-of-hearing and use TRS/VRS/WebCapTel, contact us if you require technical support or have accessibility questions by calling (877) 656-7058, Monday through Friday, 6 a.m. to 9 p.m. Mountain Time.